

Collezioni Sammlungen Collections Colecciones

THE OUTDOOR COLLECTION



Collezioni Sammlungen Collections Colecciones

THE OUTDOOR COLLECTION

Index



Progetto originale di Angelo Mangiarotti di fioriere per esterno, 1970 / Original Angelo Mangiarotti's project of flower pots for outdoor, 1970

About Agape	04
Home. The Outdoor Within	08
Translations	12
The Outdoor Collection	15
Technical informations	50
Finishes and materials ^{insert}	64
Washbasins	52
Countertop	59
Bathtubs	60
Showers	64
Taps	68
Accessories and extras	74

About Agape La storia di Agape inizia nel 1973 e attraversa quasi 50 anni di evoluzione della cultura del progetto, dell'architettura, della tecnologia e dello stile di vita, interpretando uno degli ambienti più speciali della casa: il bagno. Spazio del contatto più intimo con l'Architettura, Agape mette l'ambiente bagno al centro della vita domestica e lo rende capace di donare ogni giorno sensazioni ed emozioni profonde. Una visione unica, a 360 gradi, dove tempo, luce, forme, materiali e temperature diventano prodotti progettati con cura e servizi realizzati su misura per elevare l'esperienza del bagno a nuovi livelli. Grazie alla collaborazione con celebri studi di architettura e premiati designer, Agape può vantare nel mondo un esteso portfolio di realizzazioni nel settore residenziale, hotellerie e contract: tante diverse interpretazioni della stanza da bagno dove ogni progetto porta il segno inconfondibile della ricerca estetica di Agape.



1



1 Lo spazio showroom di Agape a Governolo Roncoferraro vicino a Mantova, Italia.
2 Emanuele e Giampaolo Benedini.

2

Design culture Fondata e guidata da architetti, Agape fa del progetto l'anima portante del suo esteso catalogo. I prodotti sono il frutto di una continua ricerca volta a trovare le migliori risposte progettuali a specifiche esigenze funzionali ed architettoniche. Ne deriva una gamma di elementi destinati a durare nel tempo, una lunga serie di icone del design che, negli anni, hanno contribuito a cambiare radicalmente la parte più intima del paesaggio domestico contemporaneo. Particolare attenzione è dedicata ai materiali e ai processi produttivi: la gamma Agape è interamente realizzata in Italia con materie prime di qualità, cura artigianale per i dettagli, processi produttivi efficienti e rispettosi dell'ambiente, come attestato dalla certificazione LEED.



dall'alto a destra Cementoskin® 110 grigio chiaro; inox grigio chiaro RAL7044; Cementoskin® 540 verde; Cementoskin® 730 rosso mattone; inox grigio scuro RAL7021; gomma siliconica grigio RAL7045; gomma siliconica grigio scuro RAL7021; Cementoskin® 570 caffè; Petit Granit; Cementoskin® 180 grigio scuro; gomma siliconica arancio.

top right light grey Cementoskin® 110; light grey steel RAL7044; green Cementoskin® 540; brick red Cementoskin® 730; dark grey inox RAL7021; grey siliconic rubber RAL7045; dark grey siliconic rubber RAL7021; coffee Cementoskin® 570; Petit Granit; dark grey Cementoskin® 180; orange siliconic rubber.

Home. The Outdoor Within In un mondo dove le stanze convenzionali sfuggono alle tradizionali definizioni funzionali e diventano ambienti-opportunità con molteplici utilizzi, prendersi cura del proprio corpo rimane un momento saldamente legato alla propria fisicità e spazi ben delimitati. Questi limiti, queste soglie rappresentano un fertile terreno di transizione per interessanti approfondimenti e innovazioni progettuali e culturali.

Non mancano esempi nella Storia dell'Architettura e straordinari progetti contemporanei dove "dentro" e "fuori" diventano indicatori di differenti qualità spaziali con infinite possibilità di modulazione tra i due estremi.

3



4



5



6

- 3 Padiglione di Barcellona, Mies van der Rohe, 1928.
- 4 Giardino di Casa Nivola, 1951.
- 5 Casa a Procida, Bernard Rudofsky, 1938.
- 6 Casa La Quinta, Pérez Palacios Arquitectos Asociados, 2018.
ph Rafael Gamo

Le Corbusier dispone i suoi tetti-giardino al confine tra il cielo e l'architettura, tra natura e artificio. Il paesaggio cartesiano continuo del Padiglione Barcellona di Mies van der Rohe esplora i diversi modi per "scoprire" l'involucro tradizionale del manufatto edilizio. Bernard Rudofsky fonde Architettura e Natura nei suoi disegni e installazioni permeati, fino alle radici, del piacere di vivere. Pérez Palacios colloca la sua amaca al sicuro tra quattro mura ma all'aperto: effimera mediazione tra un volume d'acqua e l'azzurro infinito del cielo messicano.



Vocabolario di elementi che permettono di elaborare il progetto del bagno anche nelle situazioni spaziali più ambigue, la Collezione Outdoor comprende una selezione di prodotti che, per la natura dei loro materiali, per funzione o per innovazione, rappresentano i primi passi di un progetto che Agape affronta con la sua tradizionale cura e passione. Un percorso che proietta uno degli ambienti più speciali della casa oltre le mura, dove l'azzurro del cielo e il fruscio degli alberi diventano complemento naturale e ideale dell'esperienza bagno firmata Agape.

About Agape



The Agape showroom space in Governolo Roncoferraro near Mantua, Italy.



Emanuele and Giampaolo Benedini.

EN/ The history of Agape begins in 1973 and crosses almost 50 years of evolution in design, architecture, technology and lifestyle, interpreting one of the most special rooms in the home, the bathroom. Space of the most intimate contact with Architecture, Agape sets the bathroom at the heart of domestic life to conjure up profound sensations and emotions every day. All this thanks to a unique, all encompassing vision where time, light, shapes, materials and temperatures become products designed with utmost care and tailor made services to elevate the bathing experience to new levels. Thanks to the collaboration with world renowned architects and designers, Agape has an extensive portfolio of realizations in the residential, hotelery and contract sectors: many different interpretations of the bathroom where every detail is an unmistakable manifestation of Agape's design philosophy.

Design culture

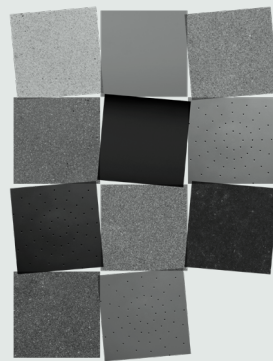

EN/ Founded and led by architects, Agape considers the project the backbone of its extensive catalogue where the items are the result of an relentless quest to find the best possible solutions for specific functional and architectural problems and requirements. The outcome is a range of products destined to last in time, a long series of icons that gave their undeniable contribution to the radical transformation of the most intimate part of the domestic landscape. Particular attention is given to materials and production methods: the Agape line is made entirely in Italy with high quality raw materials, carefully crafted detail and efficient and environmentally friendly production processes, as confirmed by its LEED certification.

DE/ Die Geschichte von Agape begann 1973 und hat fast 50 Jahre Entwicklung in Design, Architektur, Technologie und Lifestyle hinter sich gelassen und einen der speziellen Räume des Hauses, das Badezimmer, interpretiert. Agape stellt das Badezimmer – den Raum, in dem der engste Kontakt zur Architektur, Agape setzt das Badezimmer im Zentrum des häuslichen Lebens. Dadurch kann es jeden Tag tiefe Empfindungen und Emotionen hervorrufen. Eine einzigartige 360-Grad-Vision, bei der Zeit, Licht, Formen, Materialien und Temperaturen zu sorgfältig gestalteten Produkten und maßgeschneiderten Lösungen werden, die das Badezimmer-Erlebnis auf ein neues Niveau heben. Dank der Zusammenarbeit mit renommierten Architekturbüros und preisgekrönten Designern kann Agape auf ein umfangreiches Portfolio an weltweit realisierten Projekten im Wohn-, Hotel- und Contractbereich zurückblicken: unterschiedlichste Interpretationen des Badezimmers, bei denen jedes Projekt die unverwechselbare Handschrift der ästhetischen Forschung von Agape trägt.

DE/ Gegründet und geleitet von Architekten, macht Agape das Design zum Rückgrat seines umfangreichen Angebots. Die Produkte sind das Ergebnis kontinuierlicher Forschung mit dem Ziel, die besten Design-Lösungen für spezifische funktionale und architektonische Bedürfnisse zu finden. Das Ergebnis ist eine Reihe von Design-Ikonen, die im Laufe der Jahre dazu beigetragen haben, den intimsten Teil der zeitgenössischen Wohnlandschaft radikal zu verändern. Besonderes Augenmerk wird auf Materialien und Produktionsprozesse gelegt: Die Agape-Linie wird vollständig in Italien mit hochwertigen Rohstoffen, sorgfältig ausgearbeiteten Details und effizienten und umweltfreundlichen Herstellungsprozessen hergestellt, was durch die LEED Zertifizierung bestätigt wird.

FR/ L'histoire d'Agape a commencé en 1973 et a traversé près de 50 ans d'évolution de la culture du design, de l'architecture, de la technologie et du style de vie, en interprétant l'une des pièces les plus spéciales de la maison: la salle de bains. Espace de contact le plus intime avec l'architecture, Agape met la salle de bains au centre de la vie domestique et la rend capable de donner chaque jour des sensations et des émotions profondes. Une vision unique à 360 degrés où le temps, la lumière, les formes, les matériaux et les températures deviennent des produits soigneusement conçus et des services sur mesure pour élever l'expérience de la salle de bains à de nouveaux niveaux. Grâce à sa collaboration avec de célèbres cabinets d'architectes et de célèbres designers, Agape peut se vanter d'un vaste portefeuille de projets dans le secteur résidentiel, hôtelier et établissements autorisés dans le monde entier: de nombreuses interprétations différentes de la salle de bains où chaque projet porte la marque incomparable de la recherche esthétique d'Agape.

FR/ Fondée et dirigée par des architectes, Agape fait du design l'âme de son vaste catalogue. Les produits sont le résultat d'une recherche continue visant à trouver les meilleures réponses de conception aux exigences fonctionnelles et architecturales spécifiques. Il en résulte une série d'éléments destinés à durer dans le temps, une longue série d'icônes du design qui, au fil des ans, ont contribué à modifier radicalement la partie la plus intime du paysage domestique contemporain. Une attention particulière est accordée aux matériaux et aux processus de production: la gamme Agape est entièrement fabriquée en Italie avec des matières premières de qualité, un soin artisanal des détails, des processus de production efficaces et respectueux de l'environnement, comme l'atteste la certification LEED.

ES/ La historia de Agape inicia en 1973 y recorre casi 50 años de evolución de la cultura del diseño, de la arquitectura, de la tecnología y del estilo de vida, interpretando uno de los ambientes más especiales de la casa: el baño. Espacio del contacto más íntimo con la Arquitectura, Agape coloca el ambiente baño en el centro de la vida doméstica y lo vuelve capaz de brindar cada día sensaciones y emociones profundas. Una visión única, a 360 grados, donde tiempo, luz, formas, materiales y temperaturas se convierten en productos diseñados con cuidado y servicios realizados a la medida para llevar la experiencia del baño a nuevos niveles. Gracias a la colaboración con célebres estudios de arquitectura y diseñadores premiados, Agape puede hacer alarde en el mundo de una vasta cartera de obras en el sector residencial, hotelero y contract: tantas interpretaciones diferentes de la sala de baño donde cada diseño lleva el signo inconfundible del estudio estético de Agape.

ES/ Fundada y llevada por arquitectos, Agape hace del diseño el alma portante del su extenso catálogo. Los productos son el fruto de una continua búsqueda dirigida a encontrar las mejores respuestas de diseño a específicas exigencias funcionales y arquitectónicas. De esto deriva una gama de elementos destinados a durar en el tiempo, una larga serie de iconos del diseño que, a lo largo de los años, han contribuido a cambiar radicalmente la parte más íntima del paisaje doméstico contemporáneo. Se dedica particular atención a los materiales y a los procesos productivos: la gama Agape está hecha completamente en Italia con materias primas de alta calidad, cuidado artesanal en los detalles, procesos de producción eficientes y respetuosos del medio ambiente, como lo confirma su certificación LEED.

Home. The Outdoor Within



Barcelona Pavilion, Mies van der Rohe, 1928.



Garden of Casa Nivola, 1951.



House in Procida, Bernard Rudofsky, 1938.



Casa La Quinta, Pérez Palacios Arquitectos Asociados, 2018. ph Rafael Gamo

EN/ In a world where conventional rooms tend to escape the traditional definitions and become environment-opportunities with many different uses, taking care of our body remains a moment strictly linked to our physicality and well delimited spaces. These limits, these boundaries, have always been a fertile transitional territory for interesting explorations and innovative cultural and design developments. There are plenty of examples from the History of Architecture and exceptional contemporary projects where "in" and "out" became markers of different spatial qualities with endless possibilities for modulation between the two.

Le Corbusier positions his toit terrasse on the border between sky and architecture, between nature and artifact. The continuous Cartesian landscape of the Barcelona Pavilion by Mies van der Rohe explores the different ways to "discover" the traditional building envelope. Bernard Rudofsky fuses Architecture and Nature in his drawings filled with life's pleasures until the roots. Pérez Palacios locates his hammock safely between four walls, yet in the open: a subtle mediation between the pool of water and the infinite blue of the Mexican sky.

DE/ In einer Welt, in der konventionelle Räume sich von traditionellen funktionellen Definitionen lösen und zu Zweckräumen mit vielfältigen Verwendungsmöglichkeiten werden, bleibt die Körperpflege ein Moment, der fest an die eigene Körperlichkeit und an klar definierte Umgebungen gebunden ist. Diese Grenzen und Schwellen stellen einen fruchtbaren Nährboden für interessante Erkenntnisse und gestalterische und kulturelle Innovationen dar. Es mangelt nicht an Beispielen in der Architekturgeschichte und an außergewöhnlichen zeitgenössischen Projekten, bei denen "innen" und "außen" zu Indikatoren für unterschiedliche räumliche Qualitäten mit unendlichen Modulationsmöglichkeiten zwischen den beiden Extremen werden.

Le Corbusier platziert seine Dachgärten an der Grenze zwischen Himmel und Architektur, zwischen Natur und Künstlichkeit. Die kontinuierliche kartesische Landschaft des Barcelona-Pavillons von Mies van der Rohe untersucht die verschiedenen Möglichkeiten, die traditionelle Gebäudehülle zu "entdecken". Bernard Rudofsky verbindet Architektur und Natur in seinen Zeichnungen und Installationen, die bis zu den Wurzeln von der Freude am Leben durchdrungen sind. Pérez Palacios platziert seine Hängematte sicher innerhalb von vier Wänden, jedoch im Freien: ein ephemeres Zusammenspiel zwischen dem Volumen von Wasser und dem unendlichen Blau des mexikanischen Himmels.

FR/ Dans un monde où les pièces conventionnelles échappent aux définitions fonctionnelles traditionnelles et deviennent des environnements d'opportunité à usages multiples, prendre soin de son corps reste un moment fermement lié à sa physicalité et à des espaces bien définis. Ces limites, ces seuils représentent un terrain de transition fertile pour des études approfondies intéressantes et des innovations en matière de design et de culture. Les exemples ne manquent pas dans l'histoire de l'architecture et des projets contemporains extraordinaires où «l'intérieur» et «l'extérieur» deviennent des indicateurs de différentes qualités spatiales avec des possibilités infinies de modulation entre les deux extrêmes.

Le Corbusier place ses toits de jardin à la frontière entre le ciel et l'architecture, entre la nature et l'artifice. Le paysage cartésien continu du Pavillon de Barcelone de Mies van der Rohe explore différentes façons de «découvrir» l'enveloppe traditionnelle du bâtiment. Bernard Rudofsky fusionne l'architecture et la nature dans ses dessins et installations imprégnés, jusqu'aux racines, du plaisir de vivre. Pérez Palacios place son hamac en toute sécurité entre quatre murs mais à l'extérieur: médiation éphémère entre un volume d'eau et le bleu infini du ciel mexicain.

ES/ En un mundo donde las habitaciones convencionales huyen de la tradicionales definiciones funcionales y se convierten en ambientes-opportunidades con múltiples usos, dedicarse al propio cuerpo sigue siendo un momento sólidamente ligado a la propia fisicalidad y espacios bien definidos. Estos límites, estos umbrales representan un terreno fértil de transición para interesantes profundizaciones e innovaciones de diseño y cultura. No faltan ejemplos en la Historia de la Arquitectura y extraordinarios diseños contemporáneos donde "dentro" y "fuera" se convierten en indicadores de diferentes cualidades espaciales con infinitas posibilidades de modulación entre dos extremos.

Le Corbusier dispone sus techos-jardín en el límite entre el cielo y la arquitectura, entre naturaleza y artificio. El paisaje cartesiano continuo del Pabellón de Barcelone de Mies van der Rohe explora los diversos modos para "descubrir" la cubierta tradicional de la obra. Bernard Rudofsky funde Arquitectura y Naturaleza en sus diseños e instalaciones permeadas, hasta las raíces, del placer de vivir. Pérez Palacios coloca su hamaca segura entre cuatro paredes pero al abierto: efímera mediación entre un volumen de agua y el azul infinito del cielo mejicano.



A vocabulary of elements that allow to design a bathroom even in the most ambiguous spatial situations, the Outdoor Collection includes a selection of products that, due to the nature of their materials, function or innovation, become the first elements of a new project that Agape faces with its traditional care and passion. The beginning of a new path that takes one of the most special environments of the home and propels it beyond the walls, where the sky's blue, the rustle of the trees become a natural and ideal complement of the Agape bathing experience.

Ein Vokabular von Elementen, mit denen die Gestaltung des Badezimmers auch in den zweideutigsten räumlichen Situationen entwickelt werden kann. Die Outdoor-Kollektion umfasst eine Auswahl von Produkten, die aufgrund der Art ihrer Materialien, ihrer Funktion oder ihrer Innovation die ersten Schritte in einem Projekt darstellen, das Agape mit seiner traditionellen Sorgfalt und Leidenschaft in Angriff nimmt. Ein Projekt, das einen der speziellsten Räume des Hauses über die Wände hinaus projiziert, wo das Blau des Himmels und das Rascheln der Bäume zur natürlichen und idealen Ergänzung des Agape-Badezimmers werden.

Un vocabulaire d'éléments qui permet de développer le projet de salle de bains même dans les situations spatiales les plus ambiguës, la Collection Plein Air comprend une sélection de produits qui, de par la nature de leurs matériaux, leur fonction ou leur innovation, représentent les premières étapes d'un projet qu'Agape aborde avec son soin traditionnel et sa passion. Un chemin qui projette au-delà des murs l'une des pièces les plus spéciales de la maison, où le bleu du ciel et le bruissement des arbres deviennent un complément naturel et idéal à l'expérience de la salle de bains Agape.

Vocabulario de elementos que permiten elaborar el diseño del baño incluso en las situaciones espaciales más ambiguas, la Colección Outdoor comprende una selección de productos que, por la naturaleza de sus materiales, por función o por innovación, representan los primeros pasos de un diseño que Agape enfrenta con su tradicional atención y pasión. Un recorrido que proyecta uno de los ambientes más especiales de la casa más allá de las paredes, donde el azul del cielo y el murmullo de los árboles complemento natural e ideal de la experiencia baño firmada Agape.

The *Outdoor* Collection

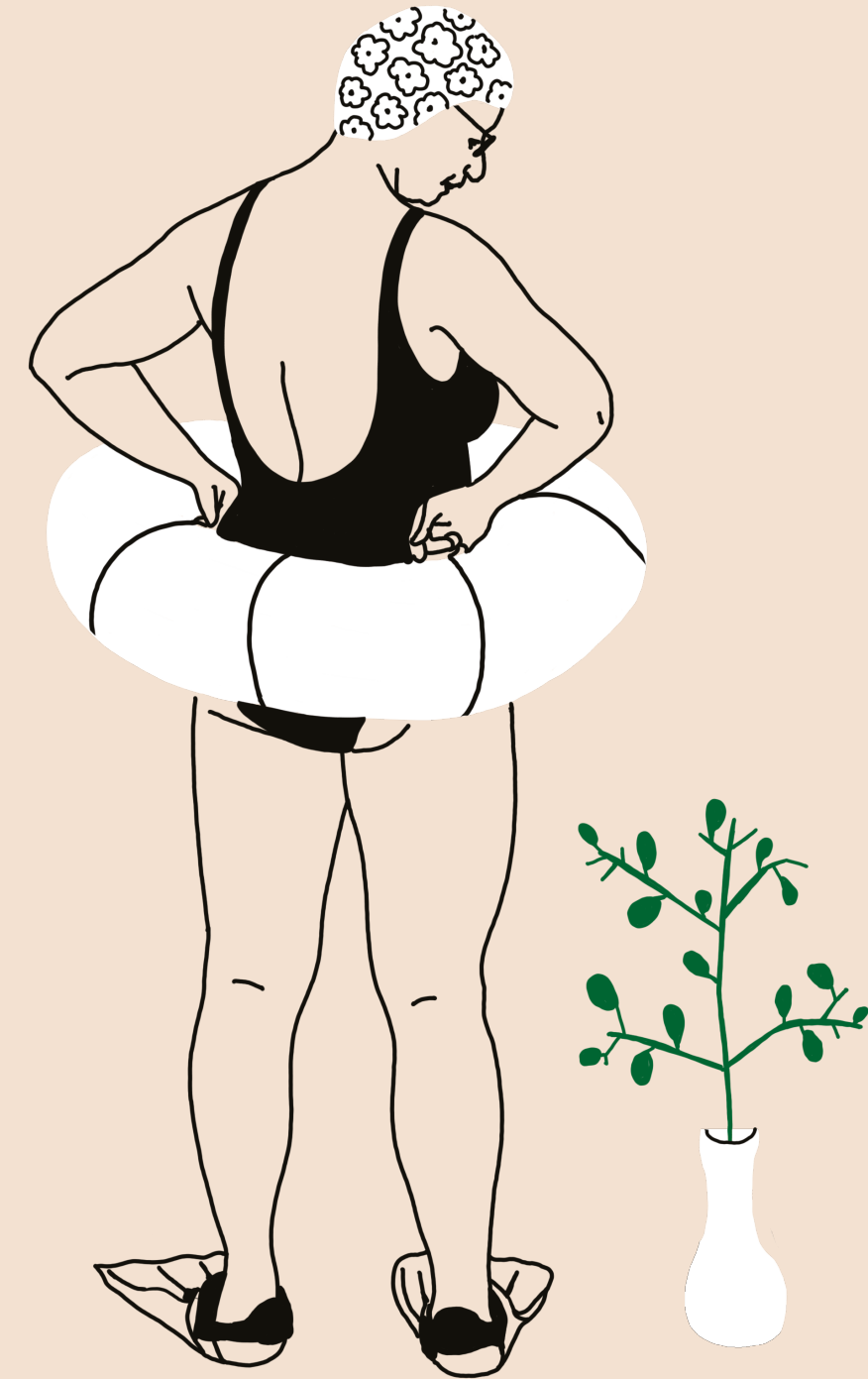



← Lavabo Bjhon 1 a colonna in Cementoskin® colore 540 con piantana Square in acciaio inox satinato (ARUB1096) / Bjhon 1 column washbasin in Cementoskin® color 540 with Square floor standing column in satin stainless steel (ARUB1096) technical informations pp. 52, 69

Pedana a doghe per doccia Petra in Cementoskin® colore 540 con doccia Square in acciaio inox satinato (ARUB1121) / Slatted tray for Petra shower in Cementoskin® color 540 with Square shower tap in satin stainless steel (ARUB1121) technical informations pp. 65, 67

Porta oggetti Ascension in iroko / Multi-purpose element Ascension in iroko wood technical informations p. 79

↑ Lavabo Bjhon 1 da appoggio in Cementoskin® colore 730 su piano Petra e rubinetto Square (ARUB1095) / Over counter-top Bjhon 1 washbasin in Cementoskin® color 730 fixed on Petra countertop with Square tap (ARUB1095) technical informations pp. 52, 59, 69



Lavabo Bjhon 1 da appoggio in Cimentoskin® colore 730 su piano Petra e rubinetto Square (ARUB1095) con accessori 369 in acciaio inox satinato / Over counter-top Bjhon 1 washbasin in Cimentoskin® color 730 fixed on Petra countertop with Square tap (ARUB1095) with 369 accessories in satin stainless steel technical informations pp. 52, 69, 77



← Lavabo Bjhon 2 a colonna in marmo Petit Granit con piantana Square in acciaio inox satinato (ARUB1096) / Bjhon 2 column washbasin in Petit Granit marble with Square floor standing tap in satin stainless steel (ARUB1096) technical informations pp. 53, 69

↑ Lavabo a parete Carrara in marmo Petit Granit con rubinetto Square in acciaio inox satinato (ARUB1082T) e accessori Mach 2 in acciaio inox satinato / Wall mounted Carrara washbasin in Petit Granit marble with Square tap in satin stainless steel (ARUB1082T) and Mach 2 accessories in satin stainless steel technical informations pp. 54, 69, 75



Lavabo a parete Handwash in Cementoskin® colore 730 con rubinetto Square in acciaio inox satinato (ARUB1082T) e accessori Mach 2 in acciaio inox satinato / Wall mounted Handwash in Cementoskin® color 730 with Square tap in satin stainless steel (ARUB1082T) and Mach 2 accessories in satin stainless steel technical informations pp. 54, 69, 75



← Lavabo e colonna a parete Petra in Cementoskin® colore 180 e rubinetto Square in acciaio inox satinato (ARUB1081) / Petra wall mounted washbasin and column in Cementoskin® color 180 and Square tap in satin stainless steel (ARUB1081) technical informations pp. 57, 69

↑ Lavabo da appoggio e piano Petra in Cementoskin® colore 730, rubinetto Square in acciaio inox satinato (ARUB1095) / Petra countertop washbasin and top in Cementoskin® color 730, Square tap in satin stainless steel (ARUB1095) technical informations pp. 57, 59, 69



Lavabo Vieques a colonna con piantana Square in acciaio inox satinato (ARUB1096) / Vieques column washbasin with Square floor standing tap in satin stainless steel (ARUB1096) technical informations pp. 58, 69



Vasca DR Cemento ad incasso in Cementskin® colore 570 e rubinetto a bordo vasca in acciaio inox lucido (ARUB0960) / Built-in DR Cemento bathtub in Cementskin® color 570 and tap fixed near the tub's edge in polished stainless steel
 technical informations pp. 61, 69

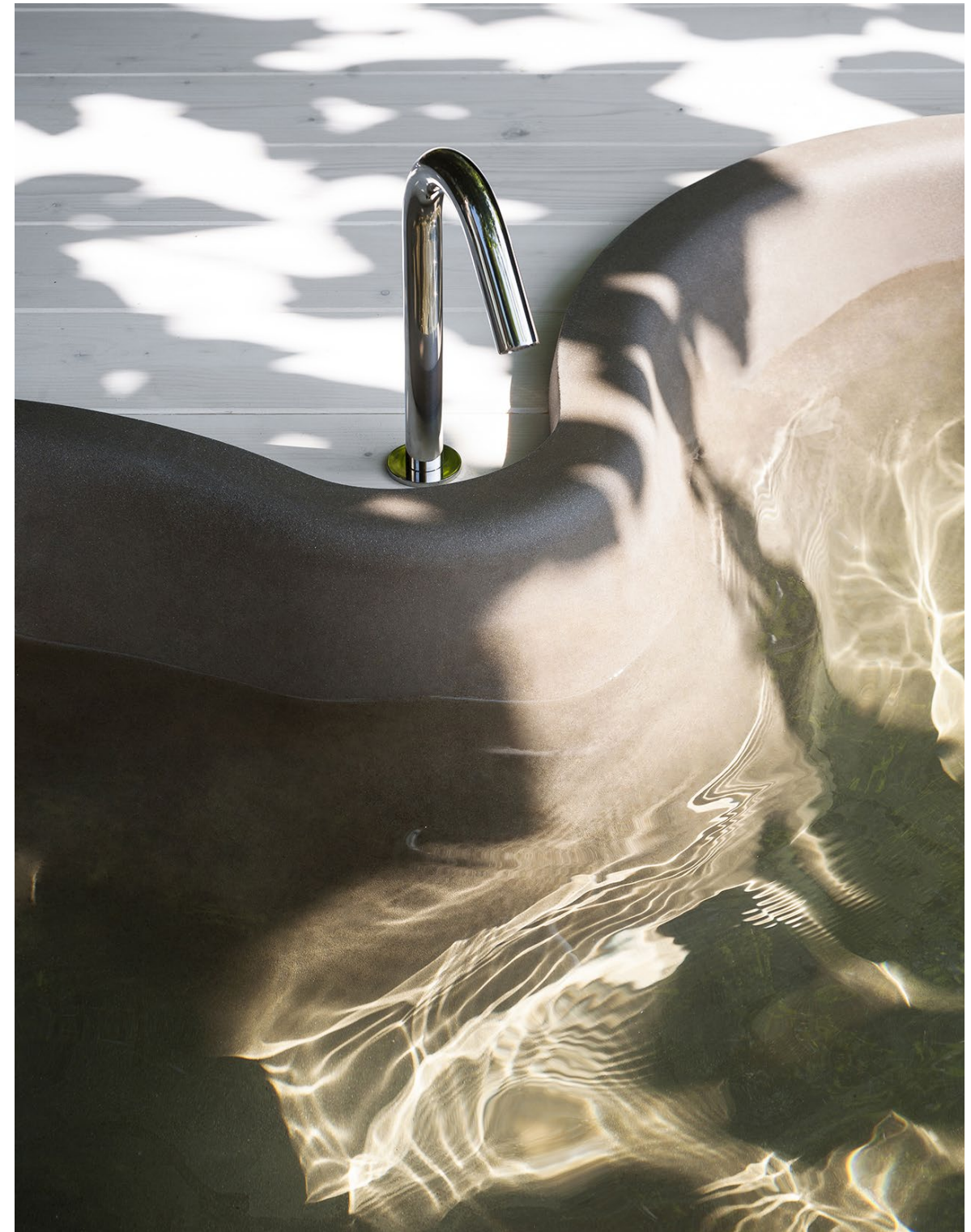

← Vasca DR Cemento free-standing in Cementoskin® colore 570 con piantana Square in acciaio inox satinato (ARUB1112) / Free-standing DR Cemento bathtub in Cementoskin® color 570 and Square column tap in stainless steel (ARUB1112) technical informations pp. 61, 69

↑ Vasca DR Cemento ad incasso in Cementoskin® colore 570 con rubinetto Square in acciaio inox lucido (.CRUB1180) / Built-in DR Cemento bathtub in Cementoskin® color 570 with Square tap in polished stainless steel (.CRUB1180) technical informations pp. 61, 69



Vasca Ufo in colore speciale verde (RAL5545U) con piantana Square in acciaio inox satinato (ARUB1115) / Ufo bathtub in customized green finish (RAL5545U) with floor standing Square tap in satin stainless steel (ARUB1115)
 technical informations pp. 62, 69



Vasca Vieques con mensola e poggiaschiena in iroko, piantana Square in acciaio inox satinato (ARUB1115) / Vieques bathtub with shelf and back rest in iroko wood, Square floor standing tap in satin stainless steel (ARUB1115) technical informations pp. 63, 69

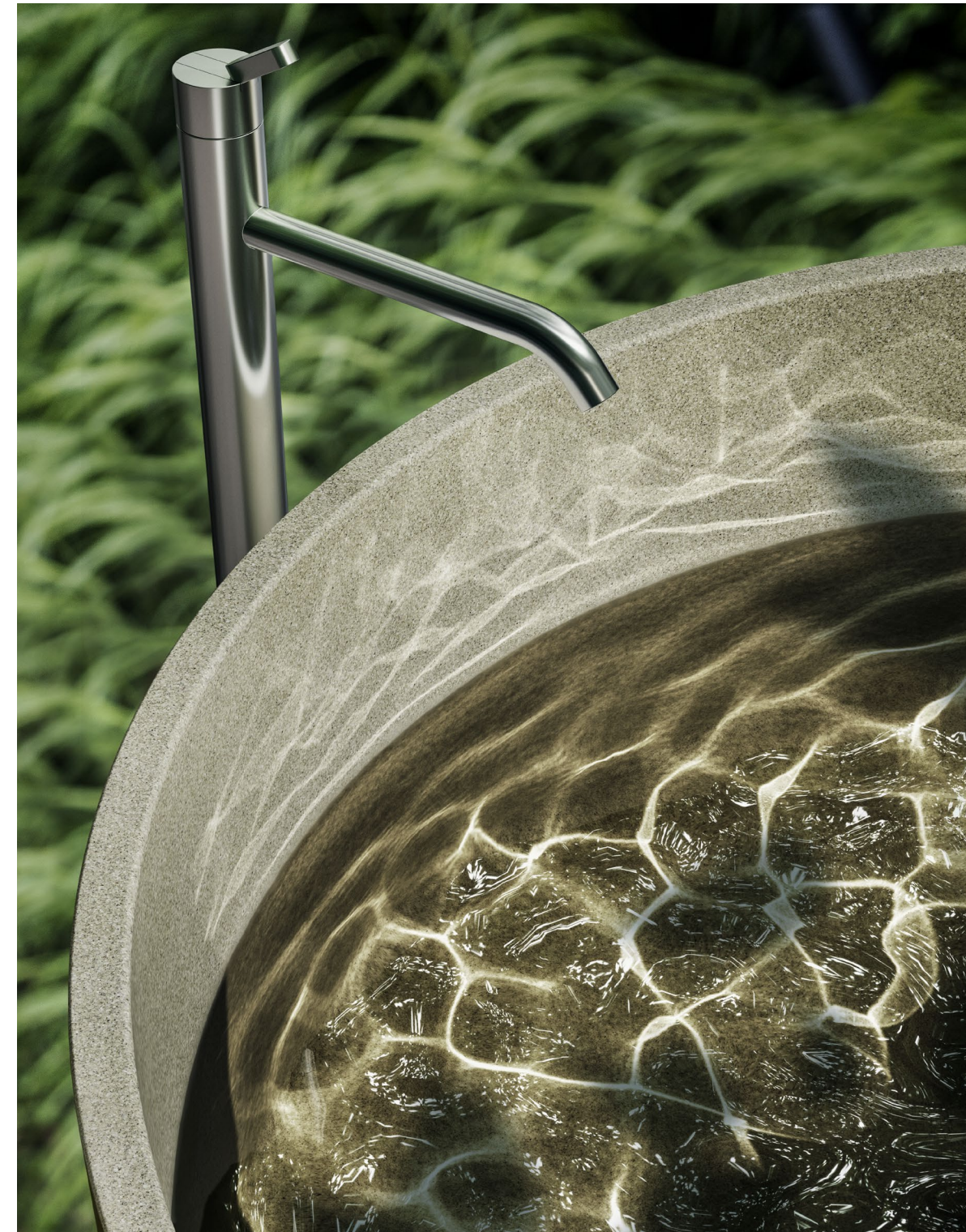

Vasca In-Out in Cementskin® colore 540 con piantana Square in acciaio inox satinato (ARUB1115) e porta oggetti multifunzione Ascension in legno iroko / In-Out bathtub in Cementskin® colour 540 with stainless steel Square floor standing tap (ARUB1115) and Ascension multi-purpose element in iroko wood technical informations pp. 62, 69, 79

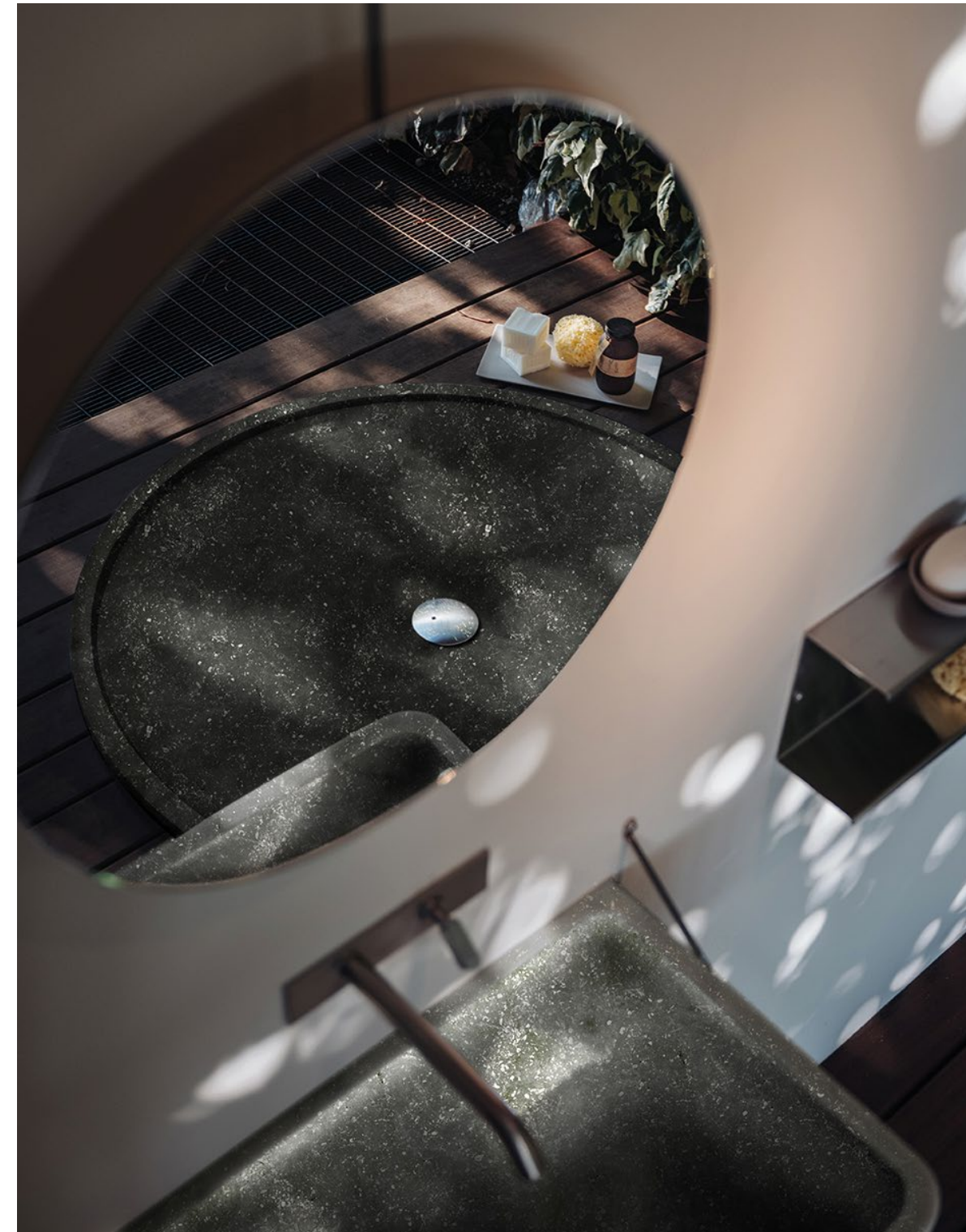

Piatto doccia Amuleto in marmo Petit Granit e doccia da terra Square in acciaio inox satinato (ARUB1121) / Amuleto shower tray in Petit Granit marble and floor standing Square shower in satin stainless steel (ARUB1121)
technical informations pp. 66, 69



Doccia da terra Open Air con base in Cementskin® colore 180 / Floor standing Open Air shower with tray in Cementskin® color 180 technical informations p. 66

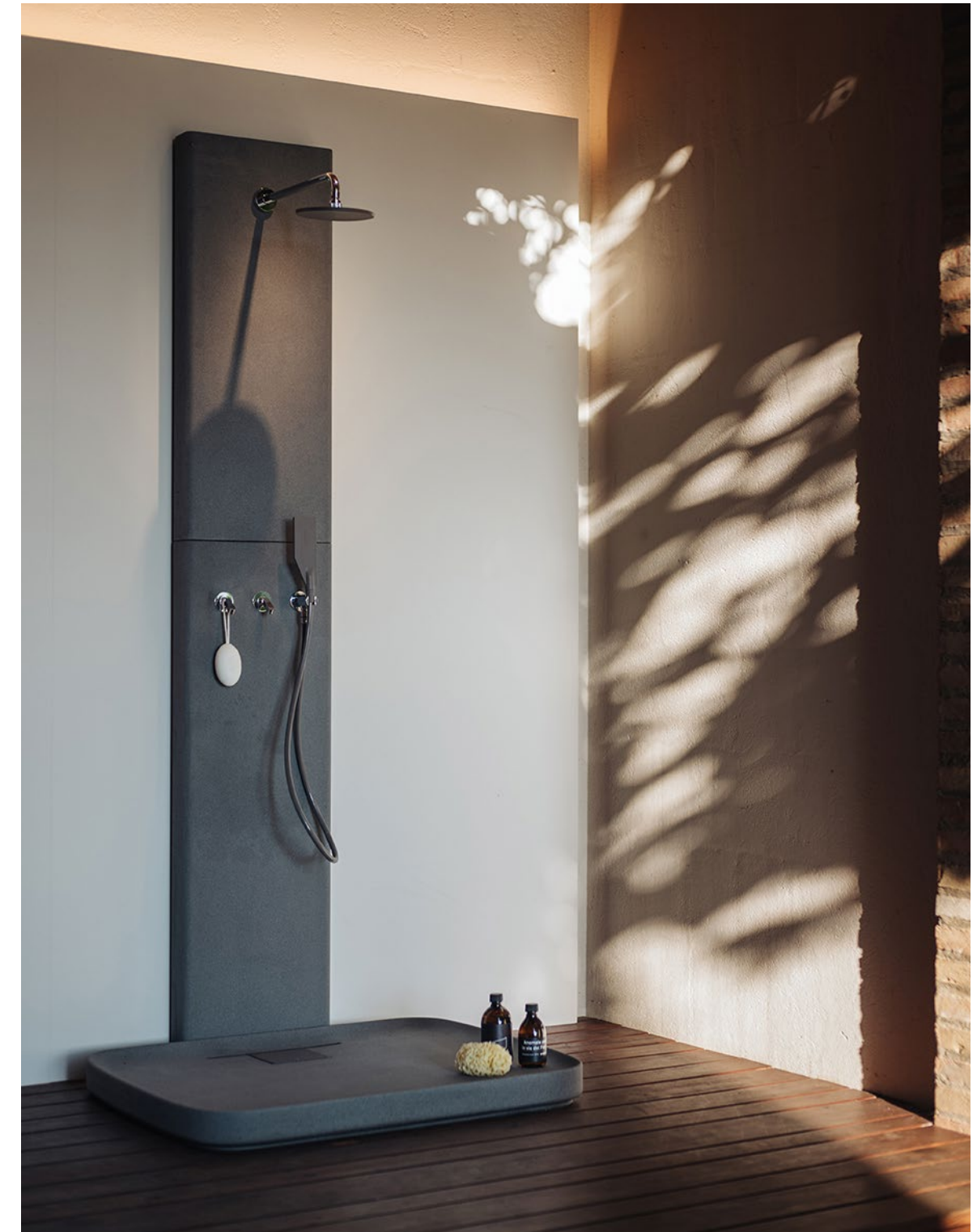

← Doccia da terra Square in acciaio inox satinato e pedana a doghe per doccia Petra, in Cementoskin® colore 570 / Floor standing Square shower tap in satin stainless steel and slatted tray for Petra shower in Cementoskin® color 570 technical informations p. 67

↑ Piatto doccia e colonna a parete Petra in Cementoskin® colore 180 con rubinetto Square in acciaio inox lucido (ARUB1029). Soffione e doccetta Kaa grigi / Petra shower tray and wall mounted column in Cementoskin® color 180 with Square tap in polished stainless steel (ARUB1029). Kaa shower head and hand held shower in grey finish technical informations pp. 65, 69



← Doccetta Kaa e miscelatore Square in acciaio inox lucido (ARUB1029) / Kaa hand held shower and Square mixer tap in polished stainless steel (ARUB1029) technical informations p. 69

↑ Piantana Square in acciaio inox satinato (ARUB1096) con lavabo Bjhon 1 in Cementoskin® colore 540 / Square floor standing tap in satin stainless steel (ARUB1096) with Bjhon 1 washbasin in Cementoskin® color 540 technical informations p. 69, 52



← Mach 2 mensola doppia (AMC20924) in acciaio inox satinato / Mach 2 double shelf (AMC20924) in satin stainless steel technical informations p. 75

↑ 369 elemento accessoriabile (A369205) e porta salviette 369 in acciaio inox satinato / 369 basic support element (A369205) and towel holder in satin stainless steel technical informations p. 77

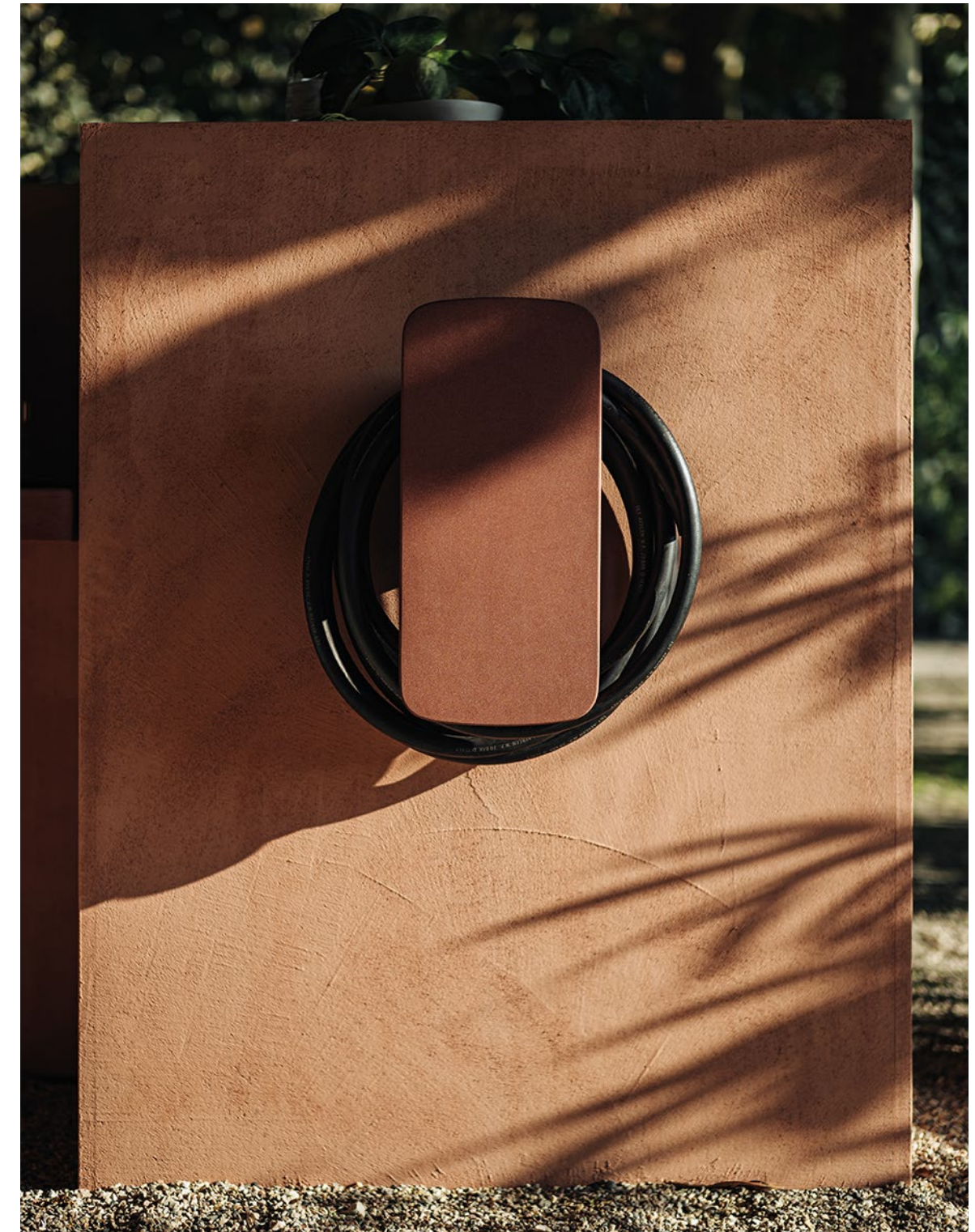

← Ascension porta oggetti multifunzione in legno iroko / Multi-purpose element Ascension in iroko wood technical informations p. 79

↑ Petra supporto per tubo di irrigazione in Cementoskin® colore 730 / Petra support for garden irrigation hose in Cementoskin® color 730 technical informations p. 79

Informazioni tecniche

Technical informations

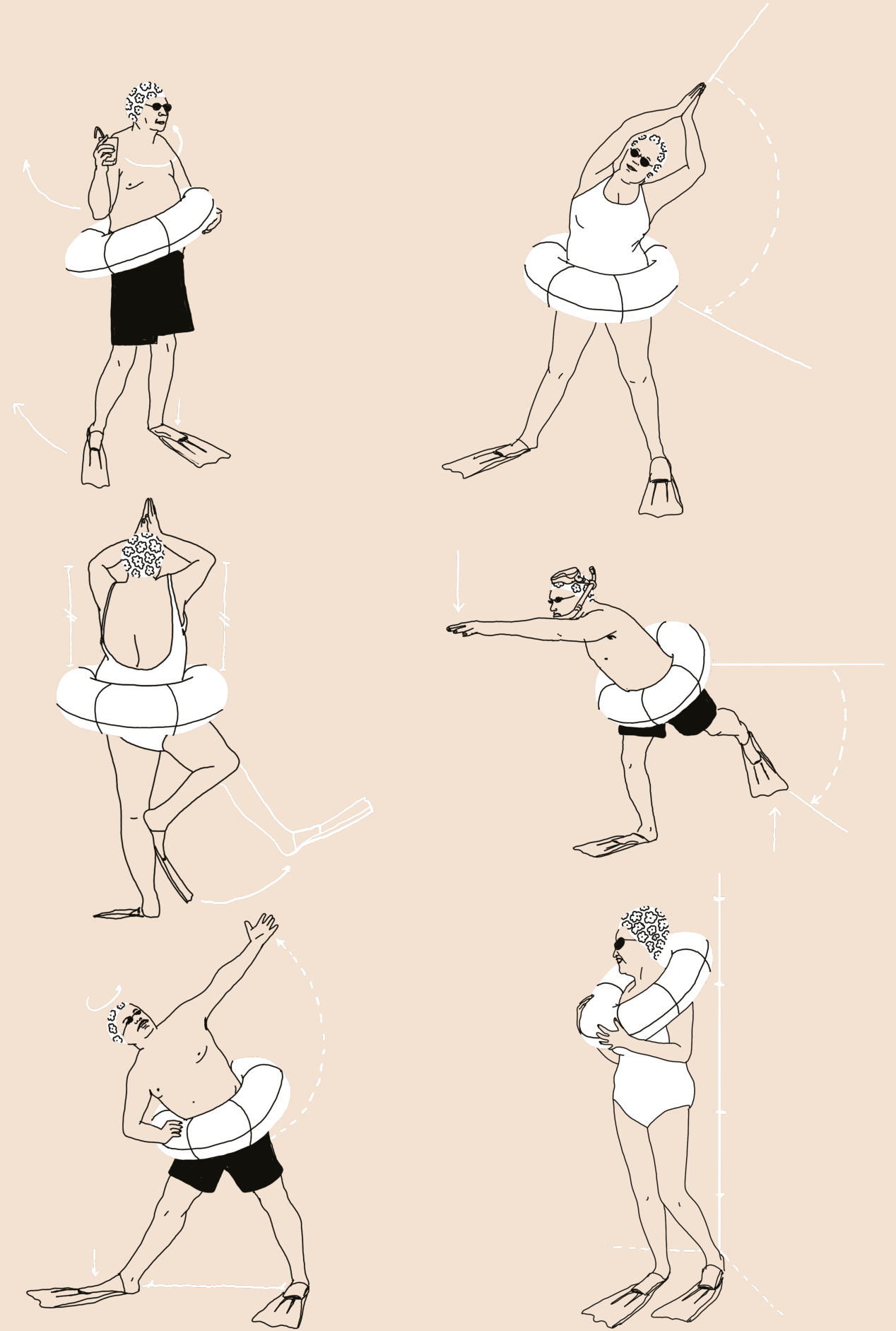

Washbasins

IT/ Lavabo in marmo Petit Granit o in Cementoskin® in diverse colorazioni; con bacino cilindrico, da appoggio o free-standing, senza foro per rubinetto, a scarico libero. Il lavabo può essere fornito anche in pietre o marmi a richiesta del cliente.

EN/ Washbasin in Petit Granit marble or Cementoskin® available in different colors, with cylindrical basin, over countertop or free-standing, without tap hole and without overflow. The washbasin can be delivered also in stone or marble types on demand.

DE/ Waschbecken aus sandgestrahlte Petit Granit oder Cementoskin® in verschiedenen Farben; mit zylindrischem Becken als Aufsatzwaschbecken, ohne Armaturenloch und Überlauf. Das Waschbecken ist auch in Stein- oder Marmorarten nach Wunsch lieferbar.

FR/ Lavabo en marbre Petit Granit ou en Cementoskin® disponible en plusieurs colorations, avec bassin cylindrique, à poser ou en îlot sans trou robinet, à écoulement libre. Le lavabo peut être fourni aussi en pierres ou marbres à la demande du client.

ES/ Lavabo en mármol Petit Granit o en Cementoskin® disponible en diferentes colores; con seno tronco cónico y de apoyo o de pie, sin agujero para grifería, a descarga libre. El lavabo se puede producir también en piedra o mármol bajo petición del cliente.

Lavabo a colonna predisposto per scarico a parete

Column washbasin designed for wall drainage

Standwaschbecken für Abfluß in der Wand

Lavabo à colonne prédisposé pour écoulement mural

Lavabo de pie predispuesto para desagüe a pared

ACER1081EM_

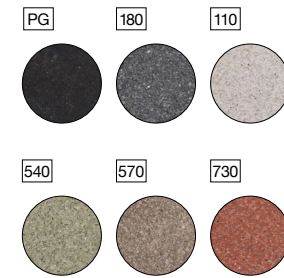
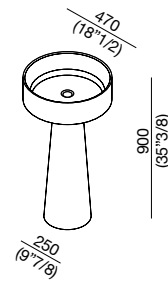

Lavabo a colonna predisposto per scarico a pavimento

Column washbasin designed for floor drainage

Standwaschbecken für Abfluß im Boden

Lavabo à colonne prédisposé pour écoulement au sol

Lavabo de pie predispuesto para desagüe a suelo

ACER1081EF_

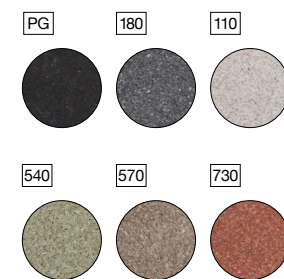
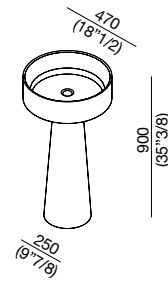

Lavabo da appoggio

Over countertop washbasin

Aufsatzwaschbecken

Lavabo à poser

Lavabo de apoyo

ACER1083E_

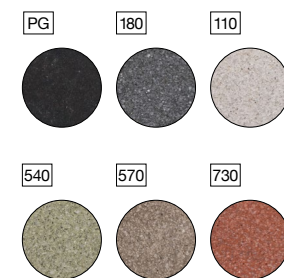
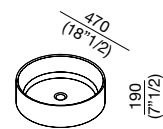

Agape Outdoor Collection

IT/ Lavabo in marmo Petit Granit; con bacino cilindrico da appoggio o free-standing, senza foro per rubinetto, a scarico libero. Il lavabo può essere fornito anche in pietre o marmi a richiesta del cliente.

EN/ Washbasin in Petit Granit marble, with cylindrical basin, over countertop or free-standing, without tap hole and without overflow. The washbasin can be delivered also in stone or marble types on demand.

DE/ Waschbecken aus sandgestrahlte Petit Granit; mit zylindrischem Becken als Aufsatzwaschbecken, ohne Armaturenloch und Überlauf. Das Waschbecken ist auch in Stein- oder Marmorarten nach Wunsch lieferbar.

FR/ Lavabo en marbre Petit Granit, avec bassin cylindrique à poser ou en îlot, sans trou robinet, à écoulement libre. Le lavabo peut être fourni aussi en pierres ou marbres à la demande du client.

ES/ Lavabo en mármol Petit Granit; con seno tronco cónico de apoyo o de pie, sin agujero para grifería, a descarga libre. El lavabo se puede producir también en piedra o mármol bajo petición del cliente.

Lavabo a colonna predisposto per scarico a parete

Column washbasin designed for wall drainage

Standwaschbecken für Abfluß in der Wand

Lavabo à colonne prédisposé pour écoulement mural

Lavabo de pie predispuesto para desagüe a pared

ACER1082EMPG_

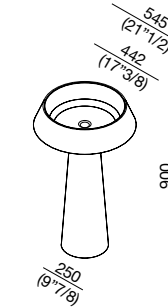

Lavabo a colonna predisposto per scarico a pavimento

Column washbasin designed for floor drainage

Standwaschbecken für Abfluß im Boden

Lavabo à colonne prédisposé pour écoulement au sol

Lavabo de pie predispuesto para desagüe a suelo

ACER1082EFPG_

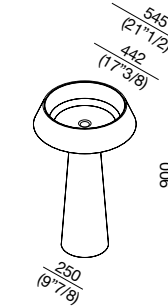

Lavabo da appoggio

Over countertop washbasin

Aufsatzwaschbecken

Lavabo à poser

Lavabo de apoyo

ACER1084EPG_

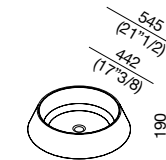

Washbasins

Carrara, Benedini Associati, 2019

IT/ Lavabo rettangolare in marmo Petit Granit; senza foro per rubinetto, a scarico libero; da appoggio o supportato da struttura in acciaio inox lucido. Il lavabo può essere fornito anche in pietre o marmi a richiesta del cliente.

EN/ Rectangular washbasin in Petit Granit marble, without overflow, without tap hole; over countertop or supported by polished stainless steel structure. The washbasin can be delivered also in stone or marble types on demand.

DE/ Rechteckiges Waschbecken aus sandgestrahltem Petit Granit; ohne Armaturenloch und ohne Überlauf als Aufsatzwaschbecken; mit Halterung aus poliertem Innoxstahl. Das Waschbecken ist auch in Stein- oder Marmorarten nach Wunsch lieferbar.

FR/ Lavabo rectangulaire en marbre Petit Granit, sans trou pour la robinetterie, à écoulement libre. À poser ou avec structure porte-lavabo en acier inox poli. Le lavabo peut être fourni aussi en pierres ou marbres à la demande du client.

ES/ Lavabo rectangular en mármol Petit Granit; sin orificio para grifería, sin rebosadero; de apoyo o sostenido para una estructura en acero inox brillo. El lavabo se puede producir también en piedra o mármol bajo petición del cliente.

Lavabo con struttura

Washbasin with support structure

Waschbecken mit Halterung

Lavabo avec structure

Lavabo con estructura

ACER0730ESPG_

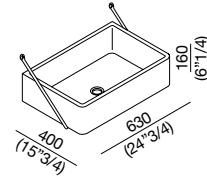

PG



Lavabo da appoggio

Over countertop washbasin

Aufsatzwaschbecken

Lavabo à poser

Lavabo de apoyo

ACER0730EPPG_

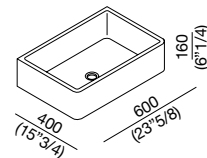

PG



Handwash, Benedini Associati, 2018

IT/ Lavamani squadrato in Cementoskin® disponibile in diverse colorazioni; con vano porta oggetti laterale, a scarico libero. Fornito senza foro per rubinetto, questo può essere realizzato a cura del cliente.

EN/ Square washbasin in Cementoskin® available in different colors, with side storage shelf, without overflow. Supplied without tap hole, it can be realised by the customer.

DE/ Quadratisches Handwaschbecken aus Cementoskin® in verschiedenen Farben; mit seitlichem Ablagefach, ohne Überlauf. Ohne Armaturenloch, letzteres kann bei Bedarf vom Kunden ausgeführt werden.

FR/ Lave-mains carré en Cementoskin® disponible en plusieurs colorations; avec compartiment porte-objets latéral, à écoulement libre. Disponible sans trou pour robinetterie, qui peut être fait par le client.

ES/ Lavamanos cuadrado en Cementoskin® disponible en diferentes colores; con vano portaobjetos lateral, sin rebosadero. Sin orificio para grifería, que puede ser realizado por parte del cliente.

Lavabo senza foro per rubinetto con vano portaoggetti

Washbasin without tap hole with side storage shelf

Waschbecken ohne Armaturenloch, mit Ablagefach

Lavabo sans trou pour robinetterie avec compartiment porte-objets

Lavabo sin orificio para grifería con vano portaobjetos

ACER09950RE_

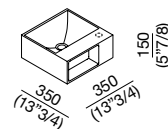

180



110



540



570



730



Washbasin Petra
design D. Vencato, M. Merendi

Installazione con colonna
/ Column mounting

Installazione a muro
/ Direct wall mounting

In appoggio su piano
/ Resting on top

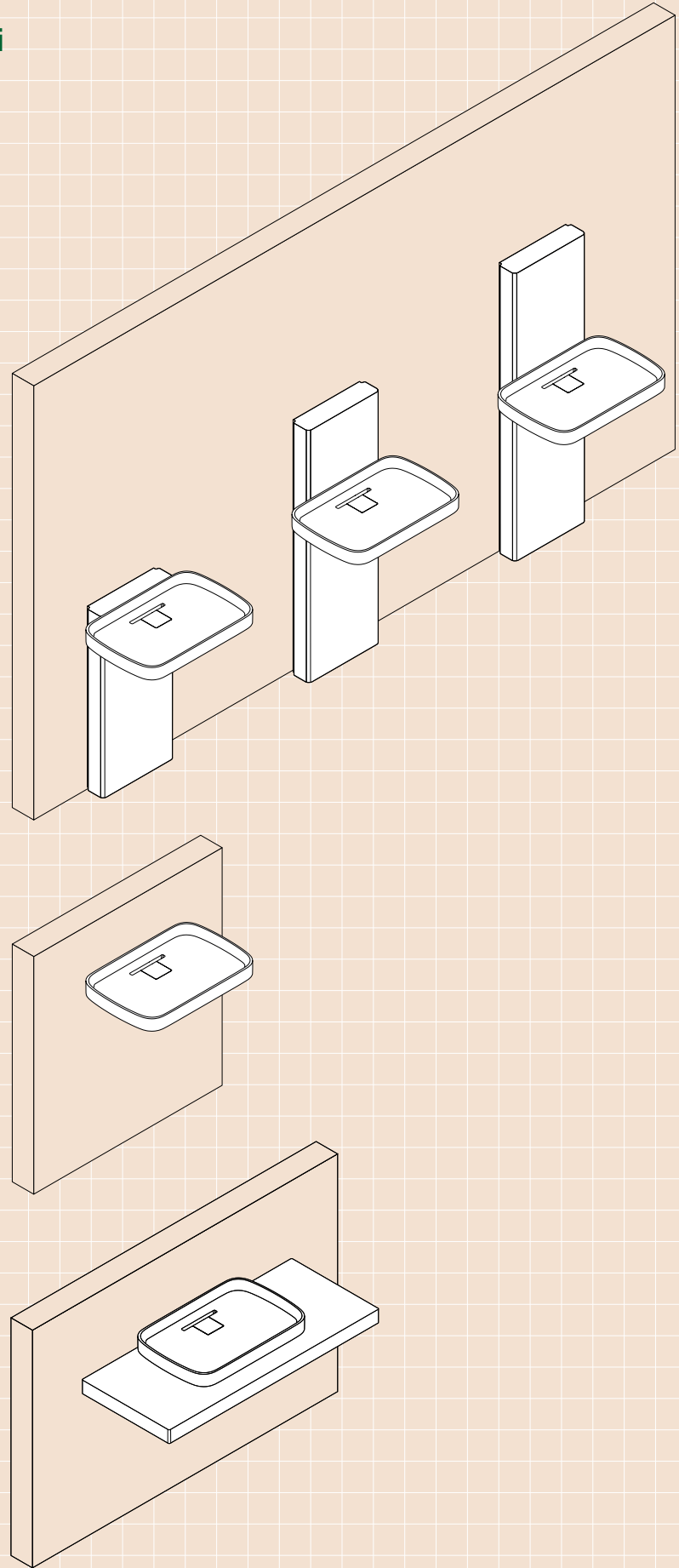

Agape Outdoor Collection

Petra, D. Vencato, M. Merendi, 2018

IT/ La famiglia Petra è realizzata in Cementoskin® disponibile in diverse colorazioni, il lavabo può essere fissato sia a parete che alla colonna attrezzata o posto su piano autoportante. Il lavabo è a scarico libero. Kit specifici permettono il fissaggio del lavabo alla parete o alla colonna. La colonna che supporta il lavabo è disponibile in 3 altezze. Non è previsto il posizionamento free standing.

EN/ The Petra family is produced in Cementoskin® available in different colours, the washbasin can be fixed to the wall or to the accessorised column or placed on a wall mounted top. The washbasin is without overflow. Specific kits allow installation of the basin to the wall or to the column. The column which supports the washbasin is available in 3 different heights. There is no free-standing version available.

DE/ Kollektion aus Cementoskin® in verschiedenen Farben, das Waschbecken kann sowohl an der Wand als auch auf der zugehörigen Säule oder auf einer selbsttragenden Waschtischplatte montiert werden. Ohne Überlauf. Entsprechende Kits ermöglichen eine Befestigung an der Wand oder auf der Säule. Die Säule, die das Waschbecken trägt ist in 3 Höhen lieferbar. Eine freistehende Aufstellung ist nicht möglich.

FR/ La famille Petra réalisée en Cementoskin® disponible en différentes couleurs, le lavabo peut être fixé au mur ou à la colonne équipée ou posé sur un plan autoportant. Le lavabo est à évacuation libre. Des kits spécifiques permettent le montage du lavabo soit au mur, soit à la colonne. La colonne qui supporte le lavabo est disponible en 3 différentes hauteurs. Le positionnement en îlot n'est pas prévu.

ES/ La familia Petra está realizada en Cementoskin® disponible en diferentes colores, el lavabo puede ser fijado sea a la pared, tanto como a la columna equipada o colocado sobre una encimera autoportante. El lavabo es sin rebosadero. Kits específicos permiten la fijación del lavabo a pared o a la columna. La columna que soporta el lavabo es disponible en 3 diferentes alturas. No está previsto el posicionamiento free standing.

Lavabo a parete o per colonna o da appoggio
Wall-mounted, column-mounted or overcountertop washbasin
Wand-oder säulenmontiertes Waschbecken oder Aufsatzwaschbecken
Lavabo mural ou sur colonne, ou à poser
Lavabo a pared o para columna o de apoyo

ACER092_

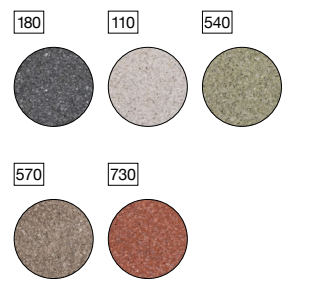
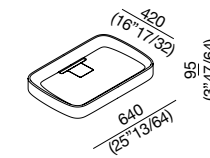

Colonna portalavabo a parete
Washbasin support column for wall mounting
Säule für Waschbecken
Colonne porte-lavabo au mur
Column porta lavabo

ACER094_
H 1400 mm (55 1/8)

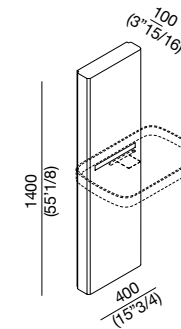

ACER095_
H 1250 mm (49 7/32)

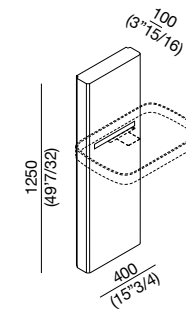

ACER096_
H 895 mm (35 15/64)

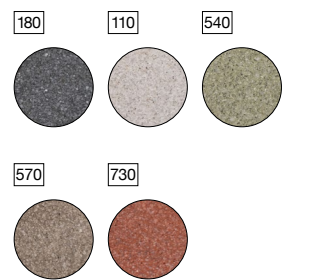
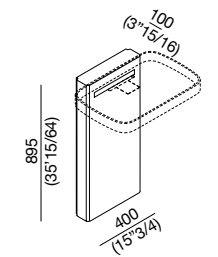

Washbasins

IT/ Famiglia di lavabi tondi da terra o da appoggio in acciaio inox verniciato bianco (RAL9003) o bicolore con esterno grigio scuro (RAL7021) o grigio chiaro (RAL7044), senza foro per rubinetto, a scarico libero. Accessoriabile con mensola porta oggetti in iroko e con gancio porta salviette in acciaio verniciato bianco. I lavabi possono essere forniti anche con colorazioni RAL a richiesta del cliente.

EN/ Family of round shaped basins for floor standing or over countertop installation, made in stainless steel painted white (RAL 9003) or in two colours, with dark grey (RAL7021) or light grey (RAL7044) exterior, without tap hole, without overflow. Can be accessorised with a iroko wood shelf and with a steel towel hook painted white. The washbasins can be also supplied in customised RAL finishes as per client's specification.

Vieques, P. Urquiola, 2018

DE/ Runde Stand oder Aufsatzwaschbecken aus Edelstahl, weiß (RAL9003) oder zweifarbig mit dunkelgrau (RAL7021) oder hellgrauem (RAL7044) Äußeren, ohne Armaturenloch und ohne Überlauf. Kann mit Ablage aus Iroko und Handtuchhaken aus weiß lackiertem Stahl ausgestattet werden. Die Waschbecken sind auch in von Kunden gewünschten RAL-Farben lieferbar.

FR/ Famille de lavabos ronds au sol ou à poser en acier inox peint en blanc (RAL9003) ou bicolore avec extérieur gris foncé (RAL7021) ou gris clair (RAL7044), sans trou pour robinetterie, à écoulement libre. Peut être accessorisé avec une étagère porte-objets en iroko et avec un crochet porte-serviettes en acier peint blanc. Les lavabos peuvent être fournis aussi avec couleurs RAL à la requête du client.

ES/ Colección de lavabos redondos de apoyo o de pie en acero inox pintado de color blanco (RAL9003) o bicolore, con exterior gris oscuro (RAL7021) o gris claro (RAL7044), sin orificio para grifería y sin rebosadero. Puede equiparse con estante portaobjetos en iroko y con gancho porta toalla en acero pintado blanco. Los lavabos se pueden suministrar también en otros colores RAL bajo petición del cliente.

Lavabo a colonna per scarico a parete

Column washbasin for wall drainage

Standwaschbecken für Abfluß in der Wand

Lavabo à colonne pour écoulement mural

Lavabo de pie para desagüe a pared

ACER0798EM_

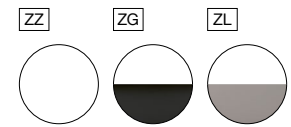
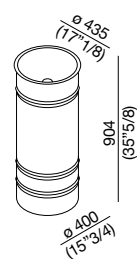

Lavabo a colonna per scarico a pavimento

Column washbasin for floor drainage

Standwaschbecken mit Abfluß im Boden

Lavabo à colonne pour écoulement au sol

Lavabo de pie para desagüe a suelo

ACER0798EF_

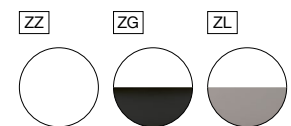
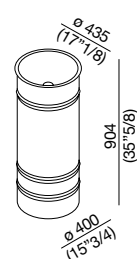

Lavabo da appoggio

Over countertop washbasin

Aufsatzwaschbecken

Lavabo à poser

Lavabo de apoyo

ACER0798EP_

H cm 19

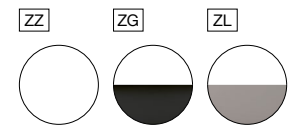
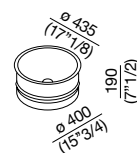

Mensola

Shelf

Ablage

Etagère

Estante

AVIE0556I

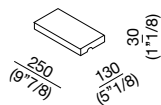

Gancio porta salviette

Towel hook

Handtuchhaken

Crochet porte-serviettes

Gancho porta toalla

AVIE0555EZ

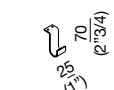

Agape Outdoor Collection

IT/ Piano autoportante realizzato in Cementoskin® disponibile in diverse colorazioni. Il piano autoportante non presenta forature per il posizionamento del lavabo, queste possono essere eseguite liberamente in opera da parte del cliente.

EN/ Self-bearing top realised in Cementoskin® available in different colours. The wall mounted top has no cut out to fit the washbasin. This can be done during installation by the customer.

DE/ Selbsttragende Waschtischplatte aus Cementoskin®, lieferbar in verschiedenen Farben. Die selbsttragende Platte wird ohne Bohrungen für das Waschbecken geliefert; diese können direkt vor Ort vom Kunden ausgeführt werden.

FR/ Plan autoportant réalisé en Cementoskin® disponible en plusieurs couleurs. Le plan autoportant ne comporte pas de trous pour le positionnement du lavabo; le client peut le percer librement pendant le montage.

ES/ Encimera autoportante realizada en Cementoskin® disponible en diferentes colores. La encimera autoportante no presenta perforaciones para el posicionamiento del lavabo, estas pueden ser realizadas libremente en obra por parte del cliente.

ACER093_

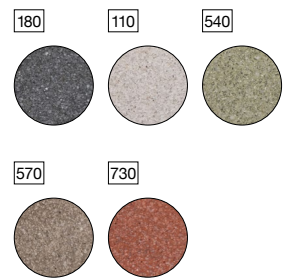
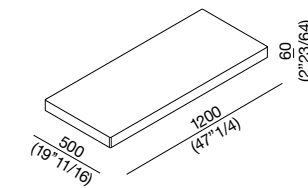

Petra + Bjhon 1

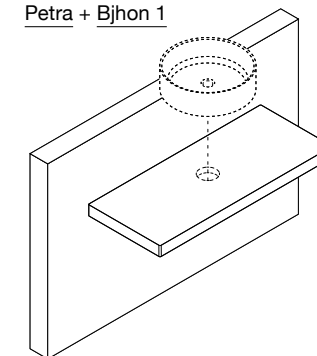

Petra + Bjhon 2

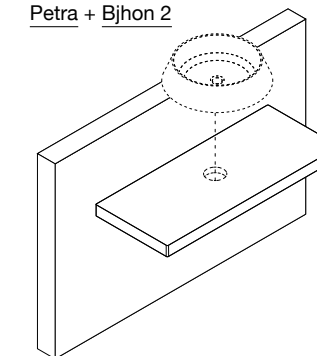

Petra + Carrara

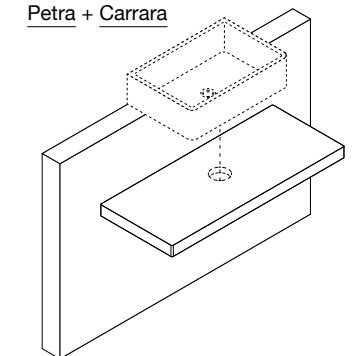

Petra + Vieques

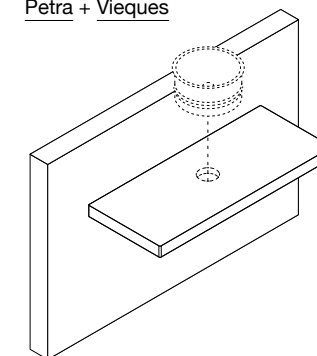

Petra + Petra

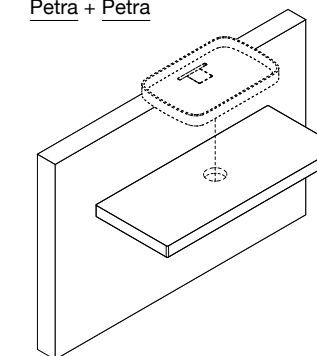

IT/ Vasca in Cementoskin® disponibile in diverse colorazioni. DR Cemento per outdoor è realizzata in versione freestanding, con o senza pannelli di finitura esterni in cemento, con troppo pieno integrato nella piletta, senza fori per rubinetteria. La versione senza struttura esterna può anche essere incassata a pavimento.

EN/ Bathtub realised in Cementoskin® in different colors. The outdoor version is available in the freestanding version, with or without external structure, with overflow integrated in the bond, without tap holes. The version without outside structure can be also built-in in the floor.

DE/ Badewanne aus Cementoskin®, in verschiedenen Farben lieferbar. DR Cemento für den Aussenbereich, freestanding, mit oder ohne Verkleidung, mit in den Ablauf, mit integriertem Überlauf. Die Variante ohne Verkleidung ist auch für den Bodeneinbau geeignet.

FR/ Baignoire en Cementoskin® disponible en plusieurs couleurs. DR Cemento pour outdoor est produite en version freestanding, avec ou sans structure externe, avec trop plein intégré dans la bonde, sans trous pour robinetterie. La version sans structure externe peut être aussi encaissée dans le sol.

ES/ Bañera realizada en Cementoskin®, disponible en diferentes colores. DR Cemento para Outdoor está disponible en versión freestanding, con o sin paneles de acabado externos en cemento, con tope lleno integrado en la válvula de desagüe, sin agujeros para grifería. La versión sin estructura externa puede también ser encajada en el suelo.

Vasca con pannelli di finitura esterni in cemento

Bathtub with external finishing panels in concrete

Badewanne mit Aussenverkleidung aus Zement

Baignoire avec panneaux de finition extérieurs en béton

Bañera con paneles de acabado externos en cemento

AVAS1091E_

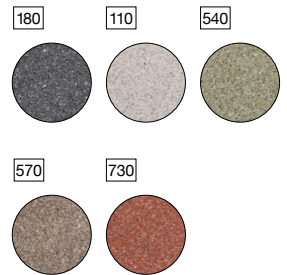
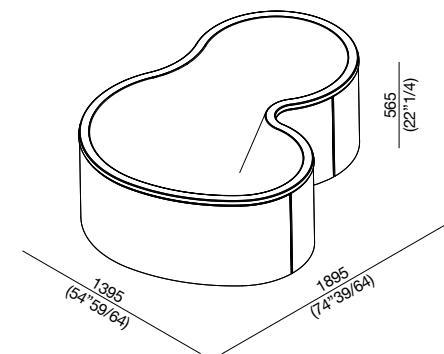

Vasca senza pannelli di finitura esterni in cemento

Bathtub without external finishing panels in concrete

Badewanne ohne Aussenverkleidung aus Zement

Baignoire sans panneaux extérieurs de finition en béton

Bañera sin paneles de acabados externos en cemento

AVAS1092E_

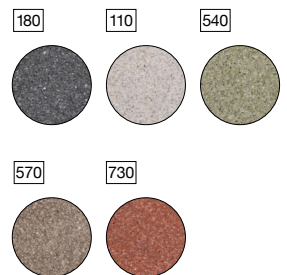
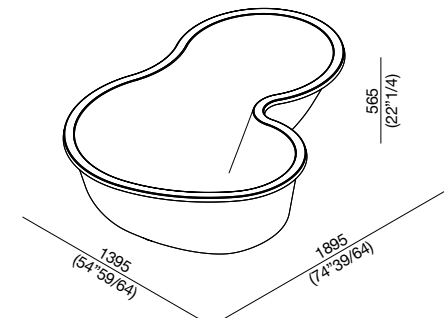

Bathtubs

IT/ Vasca con invaso tondo in Cementoskin® disponibile in diverse colorazioni, con troppo pieno integrato nella piletta cromata.

EN/ Bathtub with round interior realised in Cementoskin® in different colors, with overflow integrated in the chromed waste trap.

DE/ Runde Badewanne aus Cementoskin® in verschiedenen Farben lieferbar, mit verchromtem Ablauf mit integriertem Überlauf.

FR/ Baignoire de forme ronde en Cementoskin® disponible en plusieurs couleurs, avec trop plein intégré dans la bonde chromée.

ES/ Bañera con cuenca redonda realizada en Cementoskin® disponible en diferentes colores, con tope lleno integrado en la válvula de desagüe cromada.

AVAS1041E_

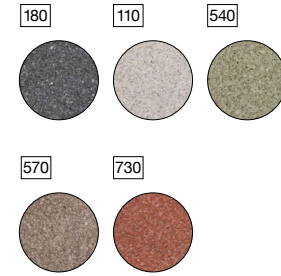
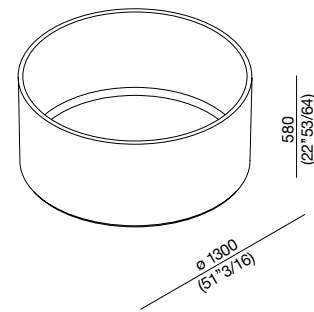

Ufo, Benedini Associati, 2018

IT/ Vasca circolare in acciaio inox verniciata in bianco (RAL9003) con esterno grigio scuro (RAL7021) o con esterno grigio scuro (RAL7021) con poggiaschiena in Cristalplant® outdoor bianco, con foro per troppo pieno senza fori per rubinetteria. Ufo può essere fornita anche con colorazioni RAL a richiesta del cliente.

EN/ Circular bathtub in stainless steel, painted in white (RAL9003) with dark grey exterior (RAL7021) with backrest in white Cristalplant® outdoor, overflow hole, without tap holes. Ufo can be also supplied in customised RAL finishes as per client's specification.

DE/ Runde Badewanne aus Edelstahl innen weiß (RAL9003), außen dunkelgrau (RAL7021) lackiert; mit Rückenstütze aus weißem Cristalplant® outdoor mit Überlauf, ohne Armaturenlöcher; Ufo kann auch in vom Kunden gewünschten RAL Farben geliefert werden.

FR/ Baignoire circulaire en acier inox peint en blanc (RAL9003) avec extérieur gris foncé (RAL7021) avec dossier en Cristalplant® outdoor blanc, avec trou pour trop-plein, sans trous pour la robinetterie; Ufo peut être fournie aussi avec couleurs RAL à la requête du client.

ES/ Bañera circular en acero inox pintada de color blanco (RAL9003) con exterior gris oscuro (RAL7021), con respaldo en Cristalplant® outdoor blanco, con rebosadero, sin orificios para grifería. Ufo puede suministrarse también en otros colores RAL bajo petición.

Vasca con 1 poggiaschiena

Bathtub with 1 backrest

Badewanne mit 1 Rückenstütze

Baignoire avec 1 dossier

Bañera con 1 respaldo

AVAS0906EZG_

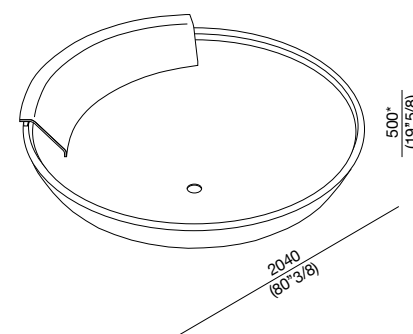

Vasca con 2 poggiaschiena

Bathtub with 2 backrests

Badewanne mit 2 Rückenstützen

Baignoire avec 2 dossiers

Bañera con 2 respaldos

AVAS0906DEZG_

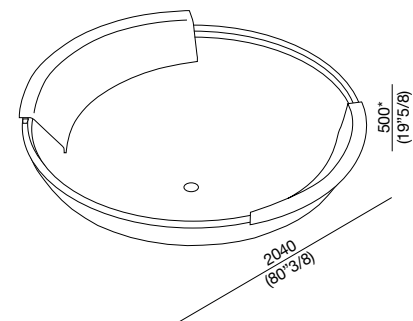

Agape Outdoor Collection

IT/ Vasca ovale in acciaio inox verniciato bianco (RAL9003) o con esterno grigio scuro (RAL7021) o grigio chiaro (RAL7044); con circuito per troppo pieno esterno bianco. Accessoriabile con poggiaschiena e ripiano porta-oggetti realizzati in iroko. La vasca può essere fornita anche con colorazioni RAL a richiesta del cliente.

EN/ Oval bathtub in stainless steel painted white (RAL9003) with dark grey (RAL7021) or light grey (RAL7044) exterior. With external overflow system painted white. Backrest and shelf in iroko wood available as accessories. The bathtub can be also supplied in customised RAL finishes as per client's specification.

DE/ Ovale Badewanne aus Edelstahl, weiß (RAL9003) oder mit dunkelgrauem (RAL7021) oder hellgrauem (RAL7044) Außen; mit weiß lackierter externer Überlaufgarnitur. Kann mit Rückenlehne und Ablage aus Iroko ausgestattet werden, die am Wannenrand eingehängt werden. Die Badewanne kann auch in vom Kunden gewünschten RAL Farben geliefert werden.

FR/ Baignoire ovale en acier inoxydable verni, blanc (RAL9003) à l'intérieur et gris foncé à l'extérieur (RAL7021) ou gris clair (RAL7044); avec circuit extérieur pour trop-plein peint blanc. Cette baignoire peut être complétée avec des accessoires comme un dossier et une tablette porte-objets réalisés en iroko. La baignoire peut être fournie aussi avec couleurs RAL à la requête du client.

ES/ Bañera oval en acero inoxidable, barnizado blanco (RAL9003) o con exterior gris oscuro (RAL7021) o gris claro (RAL7044); con circuito de rebosadero externo pintado blanco. Accesorios posibles: respaldo y repisa portaobjetos realizados en iroko a montar en el borde de la bañera. La bañera puede suministrarse también en otros colores RAL bajo petición.

Vasca Vieques

Vieques bathtub

Vieques Badewanne

Baignoire Vieques

Bañera Vieques

AVAS0911E_

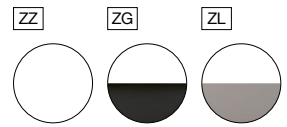
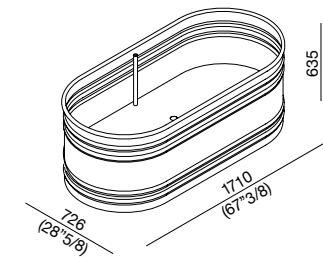

Vasca Vieques XS

Vieques XS bathtub

Vieques XS Badewanne

Baignoire Vieques XS

Bañera Vieques XS

AVAS0911E_

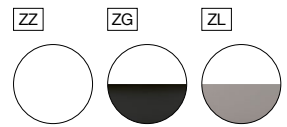
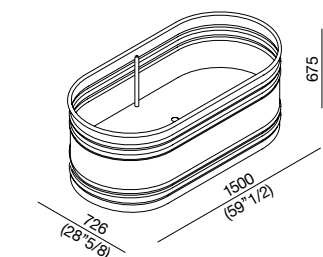

Poggiaschiena

Backrest

Rückenstütze

Dossier

Respaldo

AVAS0970I

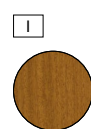
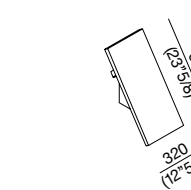

Ripiano

Shelf

Ablage

Tablette

Repisa

AVAS0971I

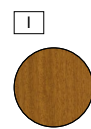
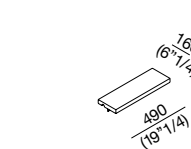

Finiture e materiali Finishes and materials

M. Merendi, 2018

FR/ Colonne, receveur et caillebotis pour douche en Cementsoskin® disponibles en plusieurs colorations. La colonne permet un positionnement personnalisé de la robinetterie. Le montage en îlot n'est pas prévu. Le receveur de la douche calque la ligne du lavabo, tandis que le caillebotis est réalisé avec des lattes.

ES/ Columna, plato y tarima para ducha realizados en Cementsoskin® disponible en diferentes colores. La columna permite el posicionamiento personalizado de la grifería. No está previsto el posicionamiento free standing. El plato de ducha calca el perfil del lavabo, mientras que la tarima se compone de listones.

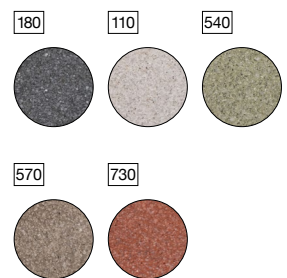
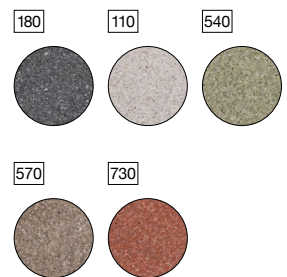
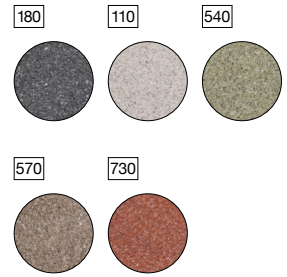

Cementoskin®

IT/ Il Cementoskin® è un composto nuovo, concepito per applicazioni outdoor e indoor. Il materiale è generato da un impasto di cemento e resina arricchito di inerti accuratamente selezionati che sono garanzia di elevate prestazioni tecniche e strutturali, anche con spessori molto ridotti. La lavorazione per colatura in stampo permette un'ampia libertà nelle geometrie, un livello molto alto di dettaglio e una elevata resistenza all'usura. La sua composizione lo rende particolarmente resistente allo sporco e garantisce caratteristiche estetiche stabili nel tempo. Realizzato con processi artigianali, le fasi di preparazione e lavorazione del materiale, per quanto controllate, sono inevitabilmente condizionate dalle caratteristiche igrometriche e climatiche stagionali che possono produrre lievi stonalizzazioni e discromie tra diversi prodotti dello stesso colore.

EN/ Cementoskin® is a new material conceived to be used both outdoors and indoors. It is a compound of concrete and resin, enriched by carefully chosen aggregates which grant its high technical and structural performance, even when used with minimal thicknesses. The material is cast molded allowing great variety of geometries, a high level of detail and high resistance to wear. Cementoskin®, thanks to its composition, is particularly resistant to dirt and maintains its aesthetic qualities unaltered in time. Being handcrafted, the different production phases, although kept under strictly controlled conditions, are inevitably influenced by hygrometric and seasonal climatic changes. This could lead to slight color shading and discoloration among products with the same finish.

DE/ Cementoskin® ist ein neues Material, das für Außen- und Innenanwendungen entwickelt wurde. Das Material wird aus einem Zement-Harz-Gemisch hergestellt, das mit sorgfältig ausgewählten Zuschlagstoffen angereichert ist, die auch bei sehr geringen Dicken eine hohe technische und strukturelle Leistung garantieren. Das Formgussverfahren ermöglicht eine große Geometriefreiheit, einen sehr hohen Detaillierungsgrad und eine hohe Verschleißfestigkeit. Seine Zusammensetzung macht es besonders schmutzresistent und garantiert langfristig unveränderliche ästhetische Eigenschaften. Die kontrollierten Vorbereitungs- und Verarbeitungsphasen des nach handwerklichen Verfahren hergestellten Materials werden unweigerlich durch hygrometrische und jahreszeitlich bedingte klimatische Eigenschaften beeinflusst, die zu leichten Farbunterschieden zwischen verschiedenen Produkten derselben Farbe führen können.

FR/ Cementoskin® est un nouveau composé, conçu pour des applications extérieures et intérieures. Le matériau est généré à partir d'un mélange de ciment et de résine enrichi de granulats soigneusement sélectionnés qui garantissent une haute performance technique et structurelle, même avec des épaisseurs très réduites. Le procédé de coulée en moule permet une grande liberté de géométrie, un très haut niveau de détail et une grande résistance à l'usure. Sa composition le rend particulièrement résistant à la saleté et garantit des caractéristiques esthétiques stables dans le temps. Réalisées selon des procédés artisanaux, les phases de préparation et de transformation du matériau, bien que contrôlées, dépendent inévitablement des caractéristiques hygrométriques et climatiques saisonnières qui peuvent produire de légères ombres et décolorations entre différents produits de la même couleur.

ES/ El Cementoskin® es un compuesto nuevo, diseñado para aplicaciones outdoor e indoor. El material se genera por una masa de cemento y resina enriquecida de inertes cuidadosamente seleccionados que son garantía de elevadas prestaciones técnicas y estructurales, incluso con espesores muy reducidos. La elaboración para colada en molde permite una libertad amplia en las geometrías, un nivel muy alto de detalle y una elevada resistencia al desgaste. Su composición lo vuelve particularmente resistente a la suciedad y garantiza características estéticas estables en el tiempo. Realizado con procesos artesanales, las fases de preparación y elaboración del material, aunque estén controladas, están condicionadas inevitablemente por las características higrométricas y climáticas de estación que pueden producir leves variaciones de tonos y decoloraciones entre diferentes productos del mismo color.

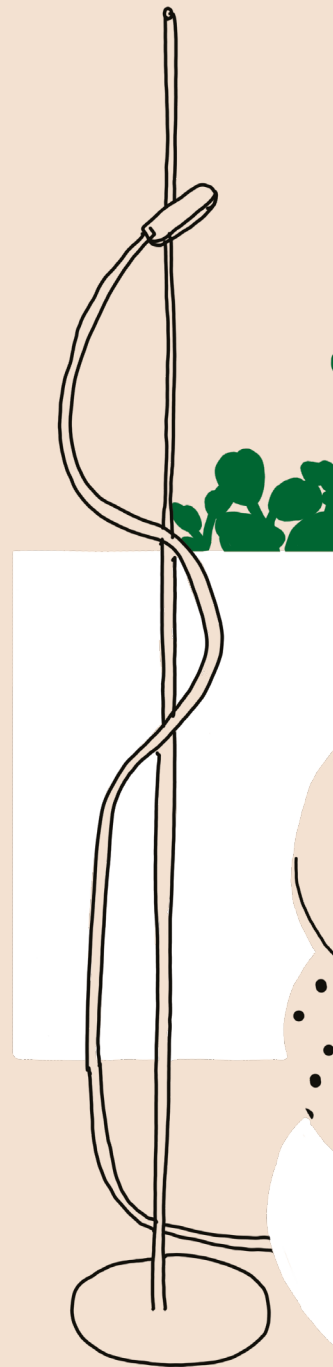

180

Cementoskin® grigio scuro
Dark grey Cementoskin®
Cementoskin® dunkelgrau
Cementoskin® gris foncé
Cementoskin® gris oscuro

110

Cementoskin® grigio chiaro
Light grey Cementoskin®
Cementoskin® hellgrau
Cementoskin® gris clair
Cementoskin® gris claro

540

Cementoskin® verde
Green Cementoskin®
Cementoskin® grün
Cementoskin® vert
Cementoskin® verde

570

Cementoskin® caffè
Coffee Cementoskin®
Cementoskin® kaffeefarben
Cementoskin® café
Cementoskin® café

730

Cementoskin® rosso mattone
Brick red Cementoskin®
Cementoskin® ziegelsteinrot
Cementoskin® brique rouge
Cementoskin® rojo ladrillo

M. Merendi, 2018

FR/ Colonne, receveur et caillebotis pour douche en Cementoskin® disponibles en plusieurs colorations. La colonne permet un positionnement personnalisé de la robinetterie. Le montage en îlot n'est pas prévu. Le receveur de la douche calque la ligne du lavabo, tandis que le caillebotis est réalisé avecattes.

ES/ Columna, plato y tarima para ducha realizados en Cementoskin® disponible en diferentes colores. La columna permite el posicionamiento personalizado de la grifería. No está previsto el posicionamiento free standing. El plato de ducha calca el perfil del lavabo, mientras la tarima se compone de listones.

180



110



540



570



730



180



110



540



570



730



180



110



540



570



730

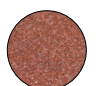

Inox

IT/ L'acciaio inox è facile da lavorare, resistente alle alte temperature e non altera colore, sapore e odore di ciò che contiene. Questo ne permette un ampio utilizzo in campo architettonico e nei vari ambienti della casa come il bagno o la cucina. Esistono diverse tipologie di questo materiale, che variano a seconda della loro composizione e vengono classificate in base alla nomenclatura AISI (American Iron and Steel Institute – Istituto di unificazione statunitense per ferro e acciaio). Per i suoi prodotti, Agape utilizza acciai AISI 304 e AISI316L, tra i più performanti attualmente disponibili sul mercato, esteticamente identici tra loro sebbene diversi per composizione chimica.

L'AISI304 è un acciaio inossidabile molto pregiato che, grazie alla sua grande stabilità chimica, assicura una durata quasi indefinita nel tempo delle sue caratteristiche estetiche e prestazionali anche in contesti dall'umidità elevata come il bagno. Grazie all'aggiunta del molibdeno e l'aumento del contenuto di nichel, l'acciaio AISI316L (dove L indica "low carbon", basso tenore di carbonio) offre prestazioni ancora più elevate ed ulteriori garanzie in ambienti particolarmente corrosivi come ad esempio quelli marini.

EN/ Stainless steel is easy to work with, resistant to high temperatures and does not alter the color, taste and smell of what it contains. This allows it to be widely used in the architectural field and in the various ambiances of the house such as the bathroom or kitchen. There are different types of this material, which vary according to their composition and are classified according to the AISI nomenclature (American Iron and Steel Institute). Agape realises its products with AISI 304 and AISI 316L steels which are among the best performing currently available on the market, aesthetically identical to each other although different in chemical composition.

AISI 304 is a very precious stainless steel which, thanks to its great chemical stability, ensures an almost indefinite duration over time of its aesthetic and performance characteristics even in contexts characterized by high humidity such as bathroom. Thanks to the addition of molybdenum and the increase in nickel content, AISI 316L (where L indicates "low carbon" content), steel offers even higher performance and further guarantees in particularly corrosive environments such as marine ones.

DE/ Edelstahl ist leicht zu bearbeiten, beständig gegen hohe Temperaturen und verändert weder Farbe, Geschmack noch Geruch der Substanzen / Materialien, mit denen er in Kontakt kommt. Dies ermöglicht eine breite Verwendung im architektonischen Bereich und in den verschiedenen Hausumgebungen wie dem Bad oder der Küche. Es gibt verschiedene Arten dieses Materials, die je nach Zusammensetzung variieren und gemäß der AISI-Nomenklatur (American Iron and Steel Institute – Amerikanisches Eisen und Stahl-Institut) klassifiziert sind. Für seine Produkte verwendet Agape die Stähle AISI304 und AISI316L, die zu den derzeit besten auf dem Markt erhältlichen Stählen gehören, ästhetisch identisch miteinander sind, sich jedoch in der chemischen Zusammensetzung unterscheiden. AISI304 ist ein sehr hochwertiger Edelstahl, der dank seiner hohen chemischen Stabilität auch in Umgebungen mit hoher Luftfeuchtigkeit wie dem Badezimmer langfristig nahezu unveränderliche ästhetische und technische Leistungsmerkmale gewährleistet. Dank der Zugabe von Molybdän und der Erhöhung des Nickelgehalts bietet der Stahl AISI316L (wobei L für "low carbon" steht) eine noch höhere Leistung und zusätzliche Garantien in besonders korrosiven Umgebungen, wie z.B. in Meeresumgebungen.

FR/ L'acier inox est facile à travailler, il résiste aux températures élevées et n'altère pas la couleur, le goût et l'odeur de ce qu'il contient. Cela permet une large utilisation dans le domaine de l'architecture et dans les différentes pièces de la maison comme la salle de bains ou la cuisine. Il existe différents types de ce matériau, qui varient en fonction de leur composition et sont classés selon la nomenclature de l'AISI (American Iron and Steel Institute – Institut américain d'unification pour le fer et l'acier). Pour ses produits, Agape utilise les aciers AISI304 et AISI316L, parmi les aciers les plus performants actuellement disponibles sur le marché, esthétiquement identiques l'un à l'autre bien que différents par leur composition chimique.

L'AISI304 est un acier inoxydable de très haute qualité qui, grâce à sa grande stabilité chimique, garantit une durée de vie presque indéfinie de ses caractéristiques esthétiques et de ses performances, même dans des contextes de forte humidité comme la salle de bains. Grâce à l'ajout de molybdène et à l'augmentation du nickel, l'acier AISI316L (où L indique «low carbon» c'est-à-dire «faible teneur en carbone») offre des performances encore plus élevées et des garanties supplémentaires dans des environnements particulièrement corrosifs tels que les milieux marins.

ES/ El acero inox es fácil de trabajar, es resistente a las altas temperaturas y no altera el color, sabor y olor de los que contiene. Esto permite un amplio uso en el campo arquitectónico y en los distintos ambientes de la casa como el baño o la cocina. Existen diferentes tipos de este material, que varían según su composición y se clasifican en base a la nomenclatura AISI (American Iron and Steel Institute – Instituto de unificación de los Estados Unidos del hierro y el acero). Para sus productos, Agape utiliza aceros AISI304 y AISI316L, entre los más eficientes actualmente disponibles en el mercado, estéticamente idénticos entre ellos, aunque diferentes por su composición química.

El AISI304 es un acero inoxidable muy preciado que, gracias a su gran estabilidad química, asegura una duración casi indefinida en el tiempo de sus características estéticas y de rendimiento incluso en contextos con humedad elevada como el baño. Gracias a la adición del molibdeno y el aumento del contenido de níquel, el acero AISI316L (donde L indica "low carbon", bajo contenido de carbono) ofrece rendimientos todavía más elevados y garantías adicionales en ambientes particularmente corrosivos como los ambientes marinos.

G

Grigio scuro RAL7021
Dark grey RAL7021
Dunkelgrau RAL7021
Gris foncé RAL7021
Gris oscuro RAL7021

L

Grigio chiaro RAL7044
Light grey RAL7044
Hellgrau RAL7044
Gris clair RAL7044
Gris claro RAL7044

Z

Bianco
White
Weiß
Blanc
Blanco

E

Nero
Black
Schwarz
Noir
Negro

A

Lucido
Polished
Poliert
Brillant
Pulido

SP

Satinato
Satin finish
Gefrostet
Givré
Escarchado

M. Merendi, 2018

FR/ Colonne, receveur et caillebotis pour douche en Cimentoskin® disponibles en plusieurs colorations. La colonne permet un positionnement personnalisé de la robinetterie. Le montage en îlot n'est pas prévu. Le receveur de la douche calque la ligne du lavabo, tandis que le caillebotis est réalisé avecattes.

ES/ Columna, plato y tarima para ducha realizados en Cimentoskin® disponible en diferentes colores. La columna permite el posicionamiento personalizado de la grifería. No está previsto el posicionamiento free standing. El plato de ducha calca el perfil del lavabo, mientras que la tarima se compone de listones.

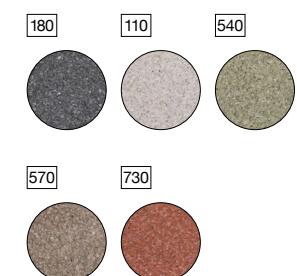
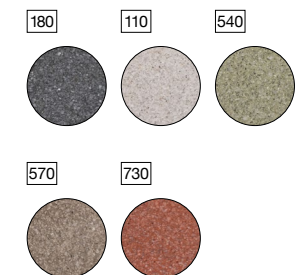
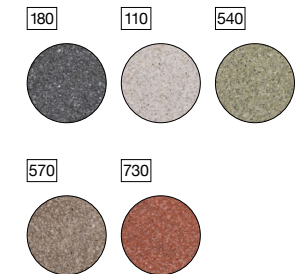

Petit Granit

IT/ Chiamata anche Pietra Blu del Belgio, il Petit Granit non appartiene alla famiglia dei graniti (pur avendo simili prestazioni meccaniche) ma è una pietra lapidea calcarea. Originaria del Belgio (dove si trovano gli unici giacimenti e dove è ampiamente utilizzata in architettura) è una pietra compatta ed omogenea con caratteristiche costanti dal colore che va dal grigio al quasi nero in base alla lavorazione e al trattamento superficiale. Data la sua compattezza, il Petit Granit è facile da pulire, non è soggetto ad infiltrazioni ed è molto resistente allo sporco e al gelo.

EN/ Also called Blue Stone of Belgium, the Petit Granit does not belong to the granite family (despite having similar mechanical performances) but is a limestone stone. Originally from Belgium (where the only deposits are found and where it is widely used in architecture) it is a compact and homogeneous stone with constant characteristics with a color ranging from gray to almost black based on the processing and surface treatment. Thanks to its compactness, the Petit Granit is easy to clean, it is not subject to infiltrations and it is very resistant to dirt and frost.

DE/ Petit Granit, auch Belgisch Granit genannt, gehört nicht zur Familie der Granite (trotz ähnlicher mechanischer Eigenschaften), sondern ist ein Kalkstein. Ursprünglich aus Belgien (wo sich die einzigen Vorkommen befinden und wo er in der Architektur weit verbreitet ist) stammend, ist er ein kompakter und homogener Stein mit konstanten Eigenschaften, die je nach Bearbeitung und Oberflächenbehandlung von grau bis fast schwarz reichen. Aufgrund seiner Kompaktheit ist Petit Granit leicht zu reinigen, er ist undurchlässig und sehr widerstandsfähig gegen Schmutz und Frost.

FR/ Aussi connu sous le nom de Pierre Bleue de Belgique, le Petit Granit n'appartient pas à la famille des granits (bien qu'ayant des performances mécaniques similaires) mais est une pierre calcaire. Originaria de Belgique (où se trouvent les seuls gisements et où elle est largement utilisée en architecture), c'est une pierre compacte et homogène dont les caractéristiques constantes vont du gris au presque noir selon le traitement et la transformation de la surface. Grâce à sa compacité, le Petit Granit est facile à nettoyer, n'est pas sujet à l'infiltration et est très résistant à la saleté et au gel.

ES/ Llamada también Piedra Azul Belga, el Petit Granit no pertenece a la familia de los granitos (a pesar de tener prestaciones mecánicas similares), sino que es una piedra lapídea calcárea. Originaria de Bélgica (donde se encuentran los únicos yacimientos y donde se utiliza ampliamente en la arquitectura) es una piedra compacta y homogénea con características constantes de color que va del gris al casi negro en base a la elaboración y al tratamiento superficial. Dada su compacidad, el Petit Granit es fácil de limpiar, no está sometida a infiltraciones y es muy resistente a la suciedad y al hielo.

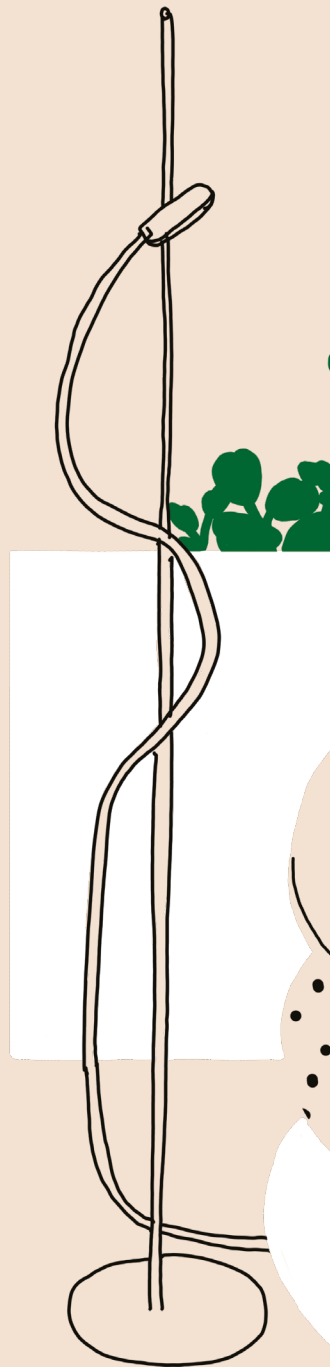

M. Merendi, 2018

FR/ Colonne, receveur et caillebotis pour douche en Cementskin® disponibles en plusieurs colorations. La colonne permet un positionnement personnalisé de la robinetterie. Le montage en îlot n'est pas prévu. Le receveur de la douche calque la ligne du lavabo, tandis que le caillebotis est réalisé avecattes.

ES/ Columna, plato y tarima para ducha realizados en Cementskin® disponible en diferentes colores. La columna permite el posicionamiento personalizado de la grifería. No está previsto el posicionamiento free standing. El plato de ducha calca el perfil del lavabo, mientras la tarima se compone de listones.

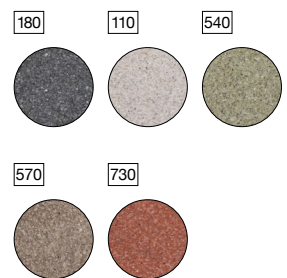
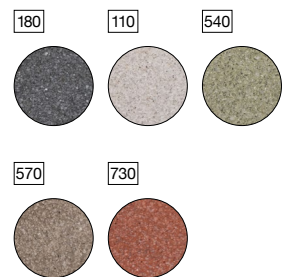
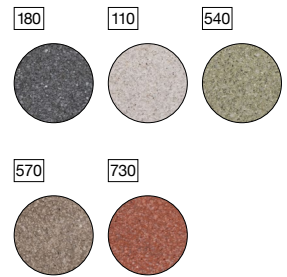

PG

Marmo Petit Granit
Petit Granit marble
Marmor Petit Granit
Marbre Petit Granit
Mármol Petit Granit

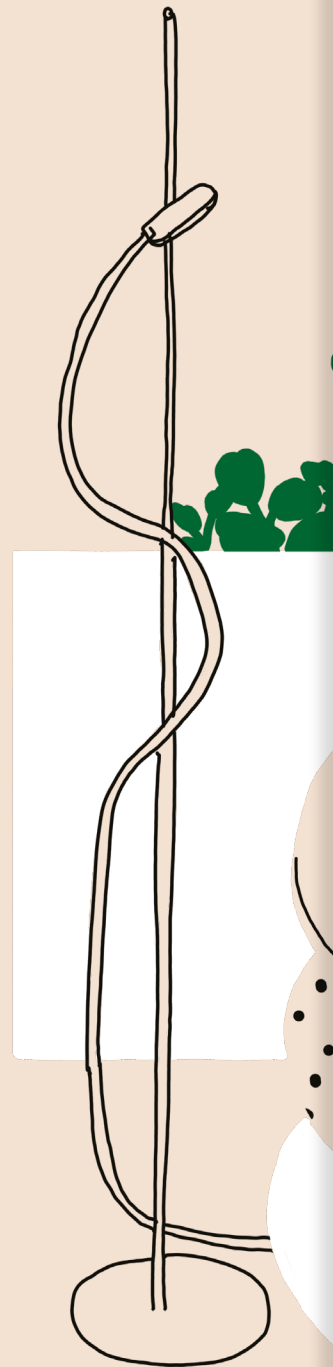

Agape Outdoor Collection

IT/ Colonna, piatto e pedana per doccia realizzati in Cementoskin® disponibile in diverse colorazioni. La colonna permette un posizionamento personalizzato della rubinetteria. Non è previsto il posizionamento free standing. Il piatto doccia ricalca la sagoma del lavabo, mentre la pedana è composta da doghe.

EN/ Column, tray and shower base are realized in Cementoskin® available in different colors. The column allows a tap's customised installation. There is no free-standing version available. The shower tray evokes the shape of the washbasin while the base is composed by drugs collected.

Petra, D. Vencato, M. Merendi, 2018

DE/ Säule, Tasse und Trittfläche für Dusche aus Cementoskin® in verschiedenen Farben. Die Säule ermöglicht eine beliebige Positionierung der Armatur. Eine freistehende Aufstellung ist nicht möglich. Die Form der Duschtasse nimmt diejenige des Waschbeckens auf, während die Trittfläche.

FR/ Colonne, receveur et caillebotis pour douche en Cementoskin® disponibles en plusieurs colorations. La colonne permet un positionnement personnalisé de la robinetterie. Le montage en îlot n'est pas prévu. Le receveur de la douche calque la ligne du lavabo, tandis que le caillebotis est réalisé avec lattes.

ES/ Columna, plato y tarima para ducha realizados en Cementoskin® disponible en diferentes colores. La columna permite el posicionamiento personalizado de la grifería. No está previsto el posicionamiento free standing. El plato de ducha calca el perfil del lavabo, mientras la tarima se compone de listones.

Colonna per doccia

Shower column

Säule für Dusche

Colonne pour douche

Columna para ducha

ACER098_

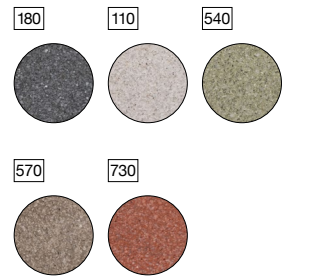
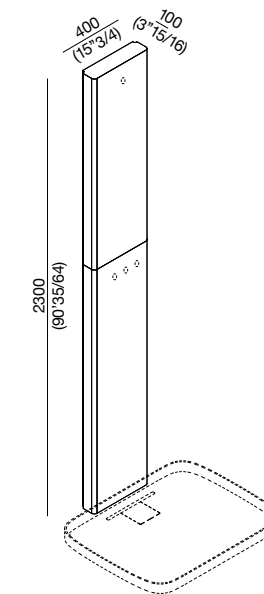

Piatto doccia

Shower plate

Duschtasse

Receveur douche

Plato de ducha

APTRD0810_

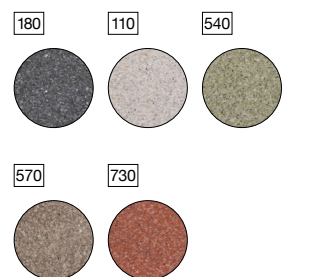
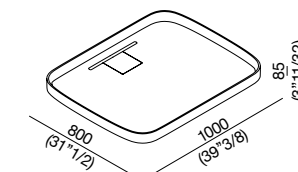

Pedana per doccia

Slatted shower tray

Trittfläche für Duschen

Caillebotis pour douche

Tarima para ducha

APTRD0808_

cm 77,4 x 77,9
(30"15/32 x 30"43/64)

APTRD0810_

cm 77,4 x 97,5
(30"15/32 x 38"25/64)

APTRD0812_

cm 77,4 x 117,1
(30"15/32 x 46"7/64)

APTRD0814_

cm 77,4 x 136,7
(30"15/32 x 53"13/16)

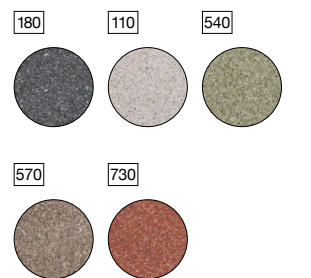
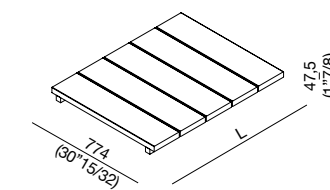

Showers

IT/ Doccia da terra con supporto in alluminio anodizzato nero e base in Cementoskin® grigio scuro. Il tubo flessibile, in PVC nero, è completo di attacco rapido per giardino. Il gruppo è dotato di sola regolazione di flusso.

EN/ Freestanding shower with support in black anodized aluminum and base in dark grey Cementoskin®. The flexible hose, in black PVC, is completed with rapid garden connection. The shower tap set only foresees the flow regulation.

Open Air, Benedini Associati, 2019

DE/ Dusche mit Halterung aus schwarz eloxiertem Aluminium und Fuß aus dunkelgrauem Cementoskin®. Der Flexschlauch aus schwarzem PVC besitzt einen Schnellverschluß für Gartenschläuche. Die Armatur besitzt nur einen Durchflussregler, keine Temperaturregelung.

FR/ Douche au sol équipé de support en aluminium anodisé noir et base en Cementoskin®. Le tuyau flexible, en PVC noir, est équipé de fixation rapide pour jardin. Le groupe est équipé seulement de régulation de flux.

ES/ Ducha a suelo con soporte en aluminio anodizado negro y base en Cementoskin®. El tubo flexible, en PVC negro, está equipado con conexión rápida para jardín. El grupo permite solo la regulación de flujo.

ADOC1631_

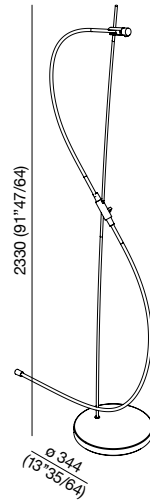

Agape Outdoor Collection

IT/ Doccia da terra in acciaio inox (AISI316) con finitura lucida o satinata, completa di comando progressivo.

EN/ Freestanding shower in polished or satin finish stainless steel (AISI 316L), complete with progressive water control.

Square, Benedini Associati, 2020

DE/ Standdusche aus Edelstahl (AISI 316L) in den Ausführungen glänzend oder matt, inklusive progressiver Bedienung.

FR/ Douche au sol en acier inox (AISI316) avec finition polie ou satinée, complète de commande progressif.

ES/ Grifería a suelo para ducha en acero inox (AISI 316) en acabado brillo o satinado, completa de mando progresivo.

ARUB1121

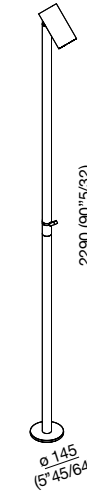

Amuleto, Benedini Associati, 2019

IT/ Piatto doccia tondo realizzato in marmo Petit Granit.

EN/ Shower tray in Petit Granit marble.

DE/ Runde Duschtasse aus Petit Granit Marmor.

FR/ Receveur douche rond réalisé en marbre Petit Granit.

ES/ Plato de ducha redondo en mármol Petit Granit.

ADOC1300PG

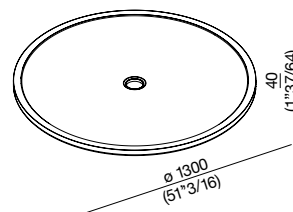

PG



Agape Outdoor Collection

Kaa, G. Gianturco, 2003

IT/ Soffione e doccia realizzati in gomma siliconica anallergica in arancio e in due tonalità di grigio. (prodotto brevettato)

EN/ Shower head and hand-held shower realised in non-allergenic rubber in orange and two grey tones. (patented product)

DE/ Kopf- und Handbrause aus antiallergenem Silikongummi in orange und zwei Grautöne. (patentiertes Produkt)

FR/ Douche de tête et douchette réalisés en caoutchouc siliconique anallergique en orange et en deux tonalités de gris. (produit breveté)

ES/ Alcachofa y ducha-dor realizados en goma de silicona antialérgica en los colores naranja y en dos tonalidades de gris. (producto patentado)

.CRUB0913_

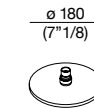

.CRUB0914_

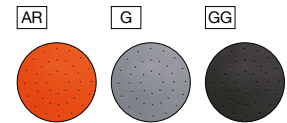
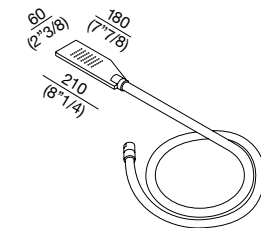

Square, Benedini Associati, 2015

IT/ Rubinetteria in acciaio inox (AISI 316L) lucido o satinato composta da gruppi miscelatori esterni o ad incasso.

EN/ External or built-in mixer tap sets in polished or satin finish stainless steel (AISI 316L).

DE/ Armaturen aus glänzendem oder mattem Edelstahl (AISI 316L), mit externen oder eingebauten Mischerguppen.

FR/ Robinetterie en acier inox (AISI 316L) poli ou satiné composée de mitigeurs externes ou à encastrer.

ES/ Grifería en acero inox (AISI 316L) brillo o mate formada por mezcladores externos o empotrados.

Gruppi lavabo / Washbasins taps / Waschbecken-Armaturen / Robinetterie pour lavabos / Grifería lavabo

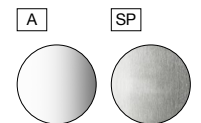

Miscelatore joystick per piano

Joystick mixer for top

Joystick-Mischer für Platte

Mélangeur joystick pour plan

Mezclador joystick para encimera

ARUB1029_



Gruppo lavabo per piano

Top mounted washbasin tap set

Waschbeckenarmatur zur Montage auf einer Ablage

Groupe lavabo pour plan

Grupo lavabo para encimera

ARUB1006_

ARUB1007_

ARUB1008_

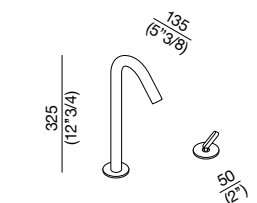
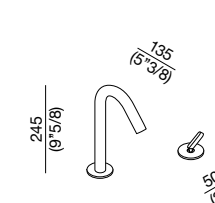
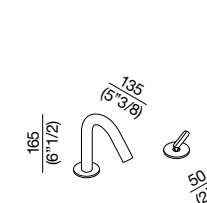

Gruppo lavabo con bocca di erogazione a parete

Washbasin unit with wall-mounted spout

Waschbeckenarmatur mit Wandauslauf

Group lavabo avec bec de débit mural

Grupo lavabo con boca de erogación a pared

ARUB1081_

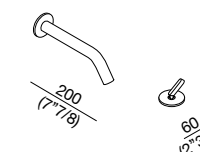

Taps

Square, Benedini Associati, 2015

Miscelatore lavabo monoforo
Single hole washbasin mixer tap
Einlochmischer für Waschbecken
Mitigeur lavabo monotrou
Mezclador lavabo monomando

ARUB1083_

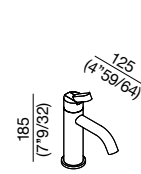

ARUB1084_

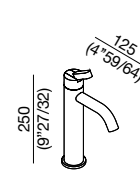

ARUB1095_

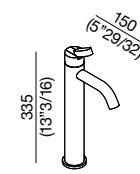

Miscelatore lavabo monoforo da terra
Floor standing washbasin mixer tap with floor connections
Bodenstenender Waschbeken-Einlochmischer
Mitigeur lavabo monotrou avec fixations au sol
Mezclador lavabo monotrou con monomando al suelo

ARUB1096_

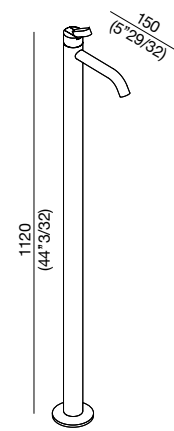

Gruppo lavabo a parete con miscelatore
Wall mounted washbasin tap set
Unterputzarmatur für Waschbecken mit Einhand-mischer
Robinetterie lavabo murale
Grifería de lavabo para empotrar a pared con mezclador

ARUB1082T_

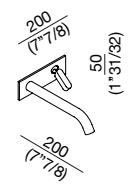

ARUB1116_

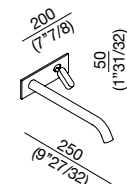

Agape Outdoor Collection

Gruppi doccia / Shower taps / Duscharmaturen / Robinetterie pour douches / Grifería duchas

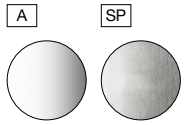

Miscelatore joystick
Built-in single lever joystick mixer tap for shower
Einhand-Joystickmischer
Mitigeur joystick
Mezclador joystick

ARUB1113_

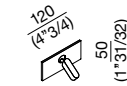

Gruppo termostatico
Thermostat unit for shower with handheld shower
Thermostatmischer
Groupe thermostatique
Grupo termostático

ARUB1119_

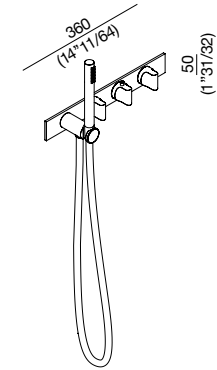

Miscelatore joystick
Recessed joystick single mixer with handheld shower
Joystickmischer Handbrause inbegriffen
Mitigeur joystick
Mezclador joystick

ARUB1110_

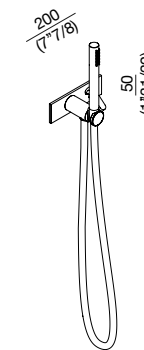

Gruppi vasca / Bathtub tap sets / Badewannen-Armaturen / Robinetterie pour baignoires / Grifería bañeras

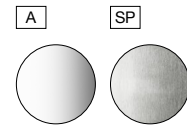

Gruppo termostatico
Thermostat unit for bathtub with handheld shower
Thermostatmischer
Groupe thermostatique
Grupo termostático

ARUB1117_
spout cm 15 – 5”29/32

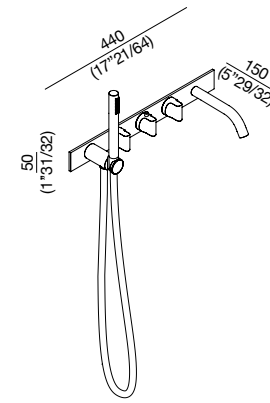

ARUB1118_
spout cm 25 – 9”27/32

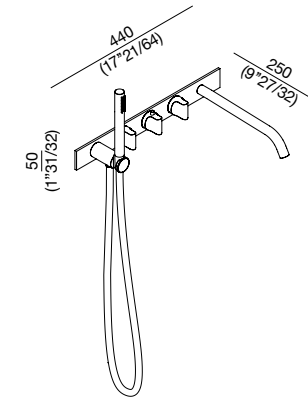

Miscelatore da terra
Floor standing bathtub mixer tap
Bodenschender Einlochmischer
Mitigeur au sol
Mezclador a suelo

ARUB1112_

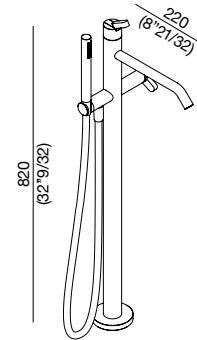

ARUB1115_

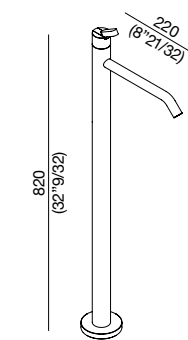

Gruppo a bordo vasca, con miscelatore e doccia
Tap set for bath rim with mixer tap and hand held shower
Armatur für den Badewannenrand mit Einhandmischer
Robinetterie pour bord de baignoire, avec mitigeur
Grifería sobre borde bañera, con mezclador y duchador

ARUB0960_

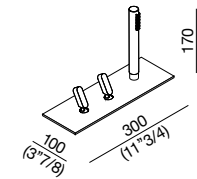

Bocca di erogazione per bordo vasca
Tap spout for bathtub's edge
Auslauf für den Badewannenrand
Bec de débit pour bord de baignoire
Caño de erogación sobre borde bañera

.CRUB1180_

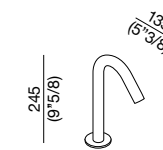

Soffioni / Shower heads / Kopfbrausen / Douches de tête / Alcachofas

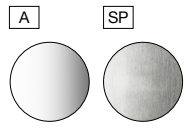

Soffione anticalcare in acciaio inox
Anti-limescale shower head in stainless steel
Anti-Kalk-Duschkopf aus Edelstahl
Pomme de douche antitartre en acier inox
Alcachofa anti cal en acero inoxidable

.CRUB1160_

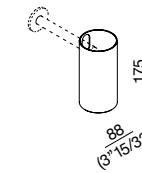

.CRUB1161_

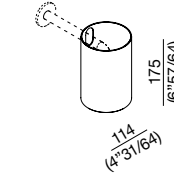

.CRUB1162_

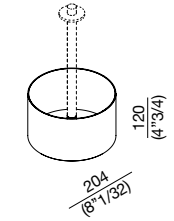

Doccetta completa di asta con cursore e presa d'acqua
Hand held shower with sliding bar and water connection
Handbrause mit Gleitstange und Wasseranschluß
Douchette complète de curseur et prise d'eau
Duchador con barra deslizante y toma de agua

.CRUB1120_

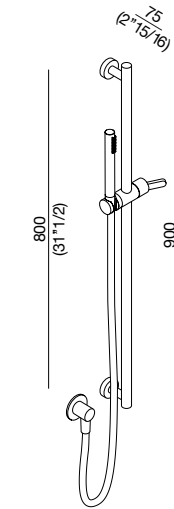

Supporti / Supports / Halterungen / Supports / Soportes

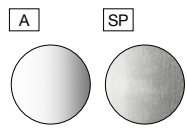

Supporto a parete in acciaio inox per soffione
Wall bracket in stainless steel for shower head
Wandhalterung aus Edelstahl für Duschköpfe
Support mural en acier inox pour pomme de douche
Soporte a pared en acero inoxidable para alcachofa

.CRUB1163_

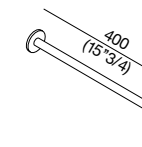

.CRUB1170_

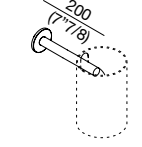

.CRUB1171_

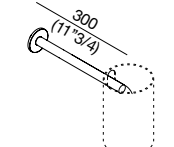

Supporto a soffitto in acciaio inox per soffione
Ceiling bracket in stainless steel for shower head
Deckenhalterung aus Edelstahl für Duschköpfe
Support au plafond en acier inox pour pomme de douche
Soporte a techo en acero inoxidable para alcachofa

.CRUB1172_

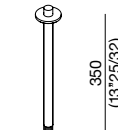

.CRUB1173_

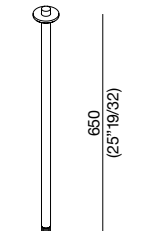

IT/ Accessori realizzati in acciaio inox AISI 304 lucido, satinato con bordi lucidi oppure verniciati in nero opaco (RAL9005).

EN/ Accessories realized in polished stainless steel, satin with polished edges or with matt black finish (RAL9005).

DE/ Accessoires aus glänzendem oder satiniertem Edelstahl mit glänzenden Kanten oder lackiert in mattschwarz (RAL9005).

FR/ Accessoires en acier inoxydable poli, satiné avec bords polis ou peints noir mat (RAL9005).

ES/ Accesorios realizados con acero inoxidable brillante, satinado con bordes brillantes o pintados de color negro opaco (RAL9005).

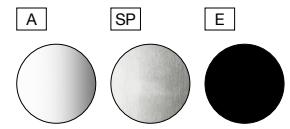

Mensola
Shelf
Spiegelablage
Tablette
Repisa

AMC20920_

AMC20921_

AMC20922_

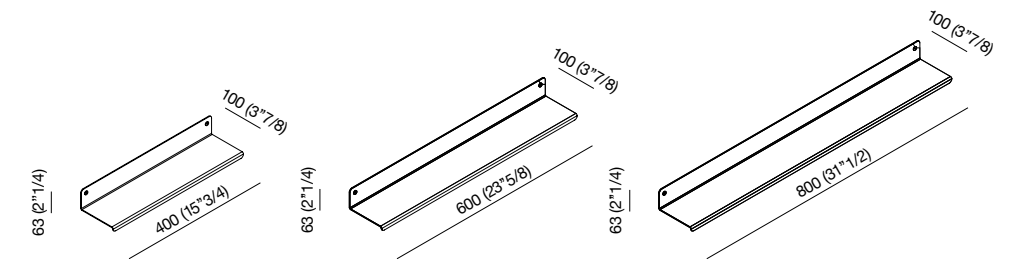

Mensola doppia
Double shelf
Doppelter Spiegelablage
Tablette double
Repisa doble

AMC20923_

AMC20924_

AMC20925_

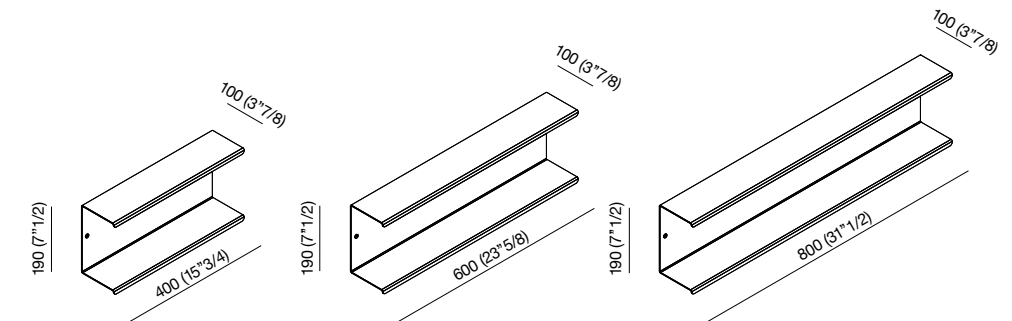

Porta sapone a parete
Wall mounted soap holder
Wand-Seifenschale
Porte-savon mural
Porta jabón a pared

AMC20926_

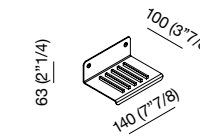

Dispenser per sapone liquido
Liquid soap dispenser
Flüssigseifenspender
Distributeur de savon liquide
Dispensador de jabón líquido

AMC20927_

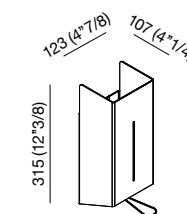

Porta salviette
Towel holder
Handtuchhalter
Porte-serviettes
Toallero

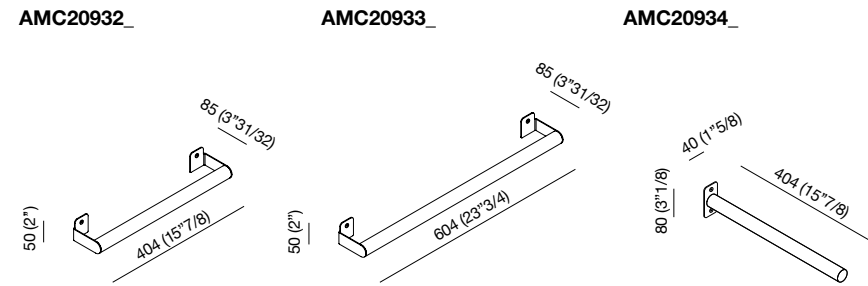

Porta abiti
Clothes hanger
Kleiderhaken
Patères
Perchero

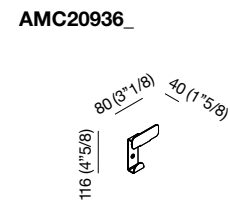

Gettacarta
Wastepaper basket
Papierkorb
Corbeille à papier
Papelera

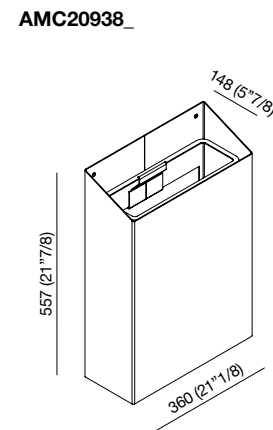

IT/ Accessori realizzati in acciaio inox (AISI 304) satinato o lucido.

EN/ Accessories in stainless steel (AISI 304) with satin or polished finish.

DE/ Accessoires aus Edelstahl (AISI 304), satiniert oder poliert.

FR/ Accessoires réalisés en acier inox (AISI 304) satiné ou poli.

ES/ Accesorios realizados en acero inox (AISI 304) satinado o brillo.

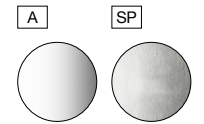

Elemento accessoriabile o porta salviette in acciaio inox
Basic support element or towel holder in stainless steel
Grundelement oder Handtuchhalter aus Edelstahl
Support en acier inox à compléter avec des accessoires coordonnés ou porte-serviettes
Elemento en acero inox a completar con accesorios combinables o toallero

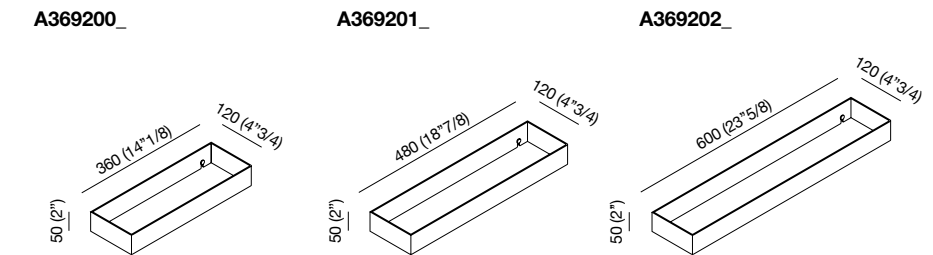

Mensola in acciaio inox
Shelf in stainless steel
Ablage aus Edelstahl
Tablette en acier inox
Repisa en acero inox

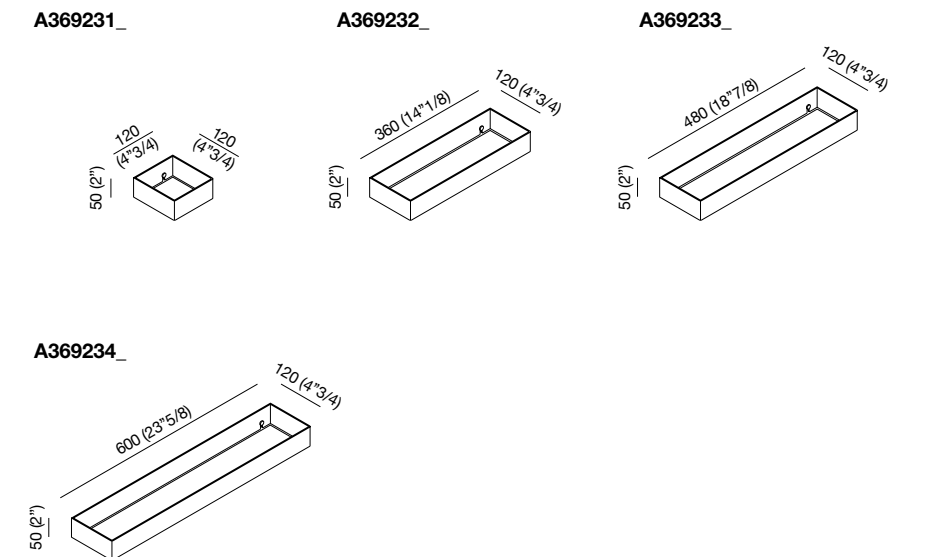

Elemento accessoriabile in acciaio inox con ripiano
Basic support element in stainless steel with shelf
Grundelement aus Edelstahl mit Ablage
Support à compléter avec des accessoires coordonnés, en acier inox avec rayon
Elemento en acero inox a completar con accesorios combinables con estante

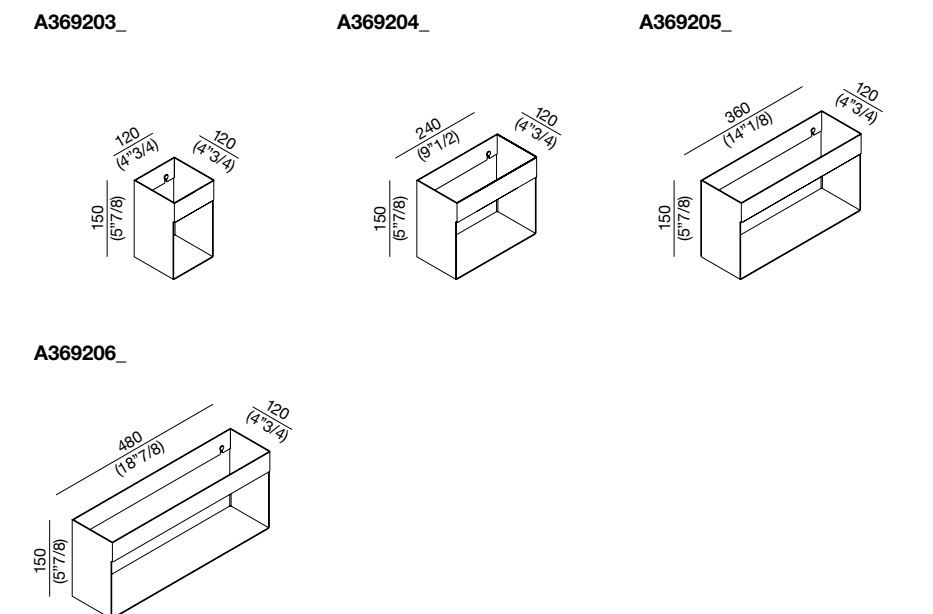

Accessories and extras

369, Benedini Associati, 2004

Porta salviette doppio in acciaio inox
 Double towel holder in stainless steel
 Doppelter Handtuchhalter aus Edelstahl
 Porte-serviettes double en acier inox
 Toallero doble en acero inox

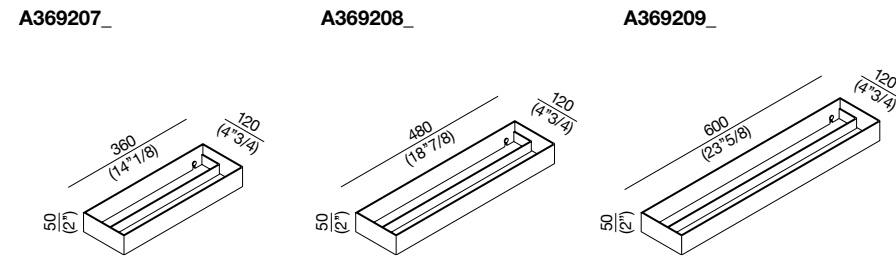

Dispenser a parete per sapone liquido
 Wall mounted dispenser for liquid soap
 Wand-Flüssigseifenspender
 Distributeur de savon liquide à fixation murale
 Dispensador de jabón líquido a pared

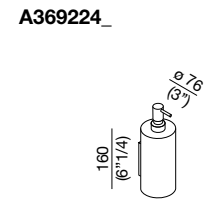

Porta abiti
 Clothes hanger
 Kleiderhaken
 Patères
 Perchero

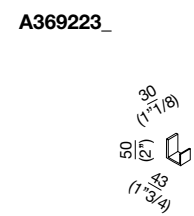

Gettacarta in acciaio inox
 Waste paper basket in stainless steel
 Papierkorb aus Edelstahl
 Corbeille à papier en acier inox
 Papelera en acero inox

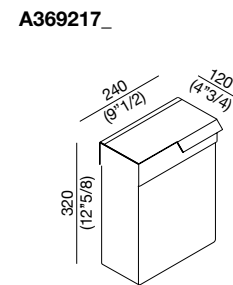

Agape Outdoor Collection

IT/ Elemento plurifunzionale realizzato in legno iroko affiancabile alla vasca Immersion.
EN/ Multi-purpose element in iroko wood, can be combined with the Immersion bath tub.

Gradino / porta oggetti in iroko
 Step / shelf for objects in iroko
 Tritt / Ablagefläche aus Iroko
 Marche / porte-objets en iroko
 Escalón / portaobjetos en iroko

Ascension, Neri&Hu, 2018

DE/ Multifunktionselement aus Irokoholz, das neben der Badewanne Immersion platziert werden kann.
FR/ Élément multifonction en bois d'iroko qui peut être placé à côté de la baignoire Immersion.
ES/ Elemento multifuncional realizado en madera de iroko que se puede unir a la bañera de Immersion.

AVAS1983I

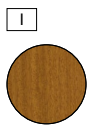
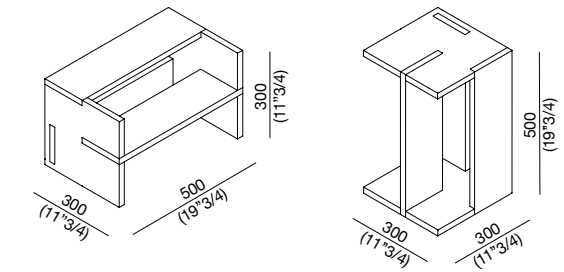

IT/ Supporto per tubo di irrigazione per giardino realizzato in Cementoskin® in diverse colorazioni.
EN/ Support for garden irrigation hose realised in Cementoskin® available in different colours.

Petra, D. Vencato, M. Merendi, 2018

DE/ Halterung für Schlauch zur Bewässerung, aus Cementoskin®, in verschiedenen Farbgebungen.
FR/ Support tuyau de irrigation pour jardin produit en Cementoskin® en plusieurs colorations.
ES/ Soporte para tubo de irrigación para jardín realizado en Cementoskin® en diferentes colores.

ACER097_

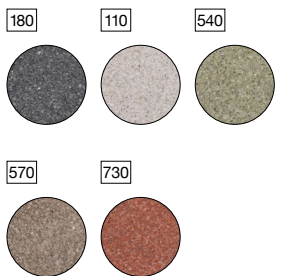
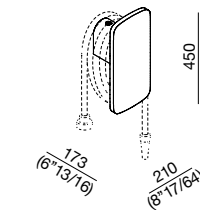

Graphic design: Roberto Barazzuol 72STEPS
Illustrations: Marta Lonardi
Copywriting: Agape
Translation: Agape, Traslo
Photography: Andrea Ferrari, Maurizio
Zatachetto, Marzio Bondavalli, Mark Seelen

CATOUTDOOR2204

©Agape srl 04.2022

Agape srl
via A. Pitentino, 6 / 46037
Governolo Roncoferraro (MN), Italy
T +39 0376 250311 / F +39 0376 250330
info@agapedesign.it www.agapedesign.it

