

Elementi Elemente Éléments Elementos

ELEMENTS CATALOGUE



Standard finishes / Finiture standard

110	Light grey Cementoskin® / Cementoskin® grigio chiaro
180	Dark grey Cementoskin® / Cementoskin® grigio scuro
540	Green Cementoskin® / Cementoskin® verde
570	Coffee Cementoskin® / Cementoskin® caffè
730	Brick red Cementoskin® / Cementoskin® rosso mattone
A, AA	Stainless steel polished / Acciaio inox lucido
B	White open-pore lacquered / Laccato bianco a poro aperto
B, BI, Z,	White lacquered / Laccato bianco
ZZ, ZB	
BG	Mat white/dark grey Ceramilux® / Ceramilux® bianco opaco/grigio scuro
BL	Mat white/light grey Ceramilux® / Ceramilux® bianco opaco/grigio chiaro
BR	Brushed burnished brass / Ottone brunito spazzolato
D	Natural brushed anodized aluminium / Alluminio anodizzato spazzolato naturale
E	Extraclear glass / Cristallo extrachiaro
E, EB	Black lacquered / Laccato nero
EB	Black ceramic / Ceramica nera
EB	Mat black / Nero opaco
ED	Dark Emperador marble / Marmo Emperador dark
G, ZG	White/dark grey solid surface / Solid surface bianco/grigio scuro
G	Light grey open-pore lacquered / Laccato grigio chiaro a poro aperto
G, GS, LG	Dark grey lacquered / Laccato grigio scuro
GC	Grey Carnic marble / Marmo grigio Carnico
GR	Dark grey ceramic / Ceramica grigio scuro
GR	Grey open-pore lacquered / Laccato grigio a poro aperto
H	Mirror / Specchio
I	Iroko / Iroko
J, G, GM	Dark grey raw earth / Terra cruda grigio scuro
L, ZL	White/light grey solid surface / Solid surface bianco/grigio chiaro
L	Light grey raw earth / Terra cruda grigio chiaro
L, GC, LZ	Light grey lacquered / Laccato grigio chiaro
M	Medium oak / Rovere medio
M	Fumé glass / Cristallo fumé
MC	White Carrara marble / Marmo bianco di Carrara
N	Light oak / Rovere chiaro
N	Dark grey open-pore lacquered / Laccato grigio scuro a poro aperto
N	Black brushed anodized aluminium / Alluminio anodizzato spazzolato nero
NE	Black leather / Cuoio nero
NM	Black Marquina marble / Marmo nero Marquina
NR	Natural brushed brass / Ottone naturale spazzolato
O	Etched glass / Cristallo acidato
PG	Petit granit marble / Marmo Petit granit
PT	Reconstituted wood, teak finish / Legno precomposto con finitura teak
RA	Raw leather / Cuoio raw
RC	Grey ash oak / Rovere cenere
RT, R	Natural oak / Rovere naturale
RU, U	Brown oak / Rovere bruno
RW, W	Dark oak / Rovere scuro
S	Chrome / Cromo
S	Transparent glass / Cristallo trasparente
SP	Stainless steel satin / Acciaio inox satinato
T	Teak / Teak
TR	Transparent / Trasparente
TT	Teak paint oak / Rovere tinto teak
VE	Green leather / Cuoio verde
VI	Green ceramic / Ceramica verde
VI	Pine green open-pore lacquered / Laccato verde pino a poro aperto
VP	Green Alpi marble / Marmo verde Alpi
Z	White ceramic / Ceramica bianca
Z	White Corian® (Glacier white) / Corian® bianco (Glacier white)
Z	White solid surface / Solid surface bianco
Z, ZZ, EX	White Cristalplant® biobased / Cristalplant® biobased bianco
ZA, AA	Glossy white Ceramilux® / Ceramilux® bianco lucido
ZB, BB	Mat white Ceramilux® / Ceramilux® bianco opaco
ZB	Mat white / Bianco opaco
ZG	White/dark grey Cristalplant® biobased / Cristalplant® biobased bianco/grigio scuro
ZG	White/dark grey ceramic / Ceramica bianco/chiaro scuro
ZG	White/dark grey lacquered / Laccato bianco/grigio scuro
ZL	White/light grey Cristalplant® biobased / Cristalplant® biobased bianco/grigio chiaro
ZL	White/light grey lacquered / Laccato bianco/grigio chiaro
ZL	White/light grey ceramic / Ceramica bianco/chiaro chiaro
ZP	Matt white ceramic / Ceramica bianco opaco
ZV	White/green pine Cristalplant® biobased / Cristalplant® biobased bianco/verde pino
ZV	White/green pine solid surface / Solid surface bianco/verde pino
ZZ, SS	White solid surface / Solid surface bianco

Index / Indice

Products Families / Famiglie Prodotto

Index / Indice

Collections / Collezioni

- The Outdoor Collection / La Collezione Outdoor
- The Memory Collection / La Collezione Memory
- The Mangiarotti Collection / La Collezione Mangiarotti

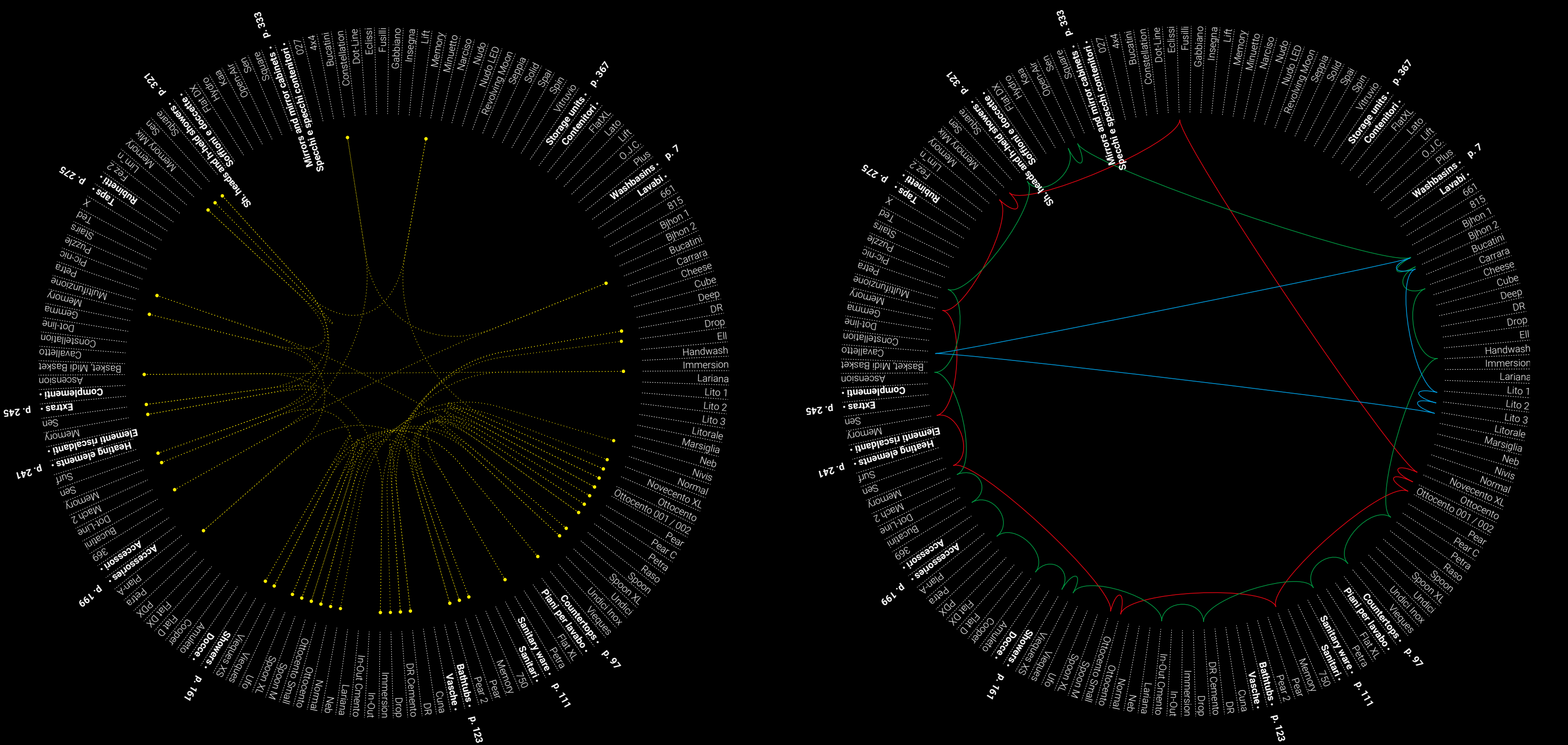

Agape Elements

Agape Elements is Agape's general product catalogue. It is a neatly organized taxonomy of everything made by us. It encompasses 127 products ordered alphabetically and divided in typologies within 11 categories engaging all the senses and covering every functional need of a bathroom environment.

We firmly believe that making architecture is about establishing relationships. Often born from specific architectural needs, the products in this catalogue are capable of establishing an intense dialogue not only between them but also with the spaces that embrace them. In **Agape Elements** we have highlighted and brought to the surface many of the invisible connections that link the elements making our range so uniquely powerful. Within the rigid constraints of an old-school paper publication, we have done everything to make this rather extensive vocabulary easy to navigate: illustrations, schemes, diagrams and technical details are all there to help you find the right product for your projects.

We are in fact architects at heart and Agape is, above all things, about the project. Since day one, we worked with architects and designers to design objects to be part of an architecture. As if they had been designed by the same, invisible hand, the elements in our catalogue are easy to combine both aesthetically and geometrically. They defy the zeitgeist and passing trends to offer long lasting solutions thanks to the quality of our materials and to the adherence to good design principles that will never go out of fashion.

Agape Elements is a carefully curated vocabulary. Much more than the sum of its parts, it is your fundamental tool to help you designing complete, one-stop solutions for what still remains the most intimate part of the contemporary domestic landscape: the bathroom.

Agape Elements

Agape Elements è il catalogo generale dei prodotti Agape. È una tassonomia sapientemente organizzata di tutto ciò che produciamo. Comprende 127 prodotti ordinati alfabeticamente e divisi in tipologie in 11 categorie che coinvolgono tutti i sensi e coprono ogni esigenza funzionale dell'ambiente bagno.

Crediamo fermamente che fare architettura è stabilire relazioni. Spesso nati da esigenze progettuali specifiche, i prodotti nel nostro catalogo sono capaci di stabilire un dialogo intenso tra di loro e con lo spazio che li accoglie. In **Agape Elements**, abbiamo evidenziato e portato in superficie molte delle relazioni che collegano i nostri elementi rendendo la nostra gamma così unica. Rimanendo entro i limiti rigidi di una pubblicazione cartacea, abbiamo fatto di tutto per rendere questo vasto vocabolario facile da navigare: illustrazioni, schemi, diagrammi e dettagli tecnici sono lì per aiutarvi a trovare il prodotto giusto per i vostri progetti.

Siamo infatti architetti nel cuore e Agape, prima di tutto, è progetto. Dal primo giorno abbiamo lavorato con architetti e designer per disegnare oggetti affinché diventino parte di un'architettura. Come se fossero stati progettati dalla stessa, invisibile mano, gli elementi nel nostro catalogo sono facili da combinare sia esteticamente che per la loro geometria. I nostri prodotti sfuggono lo spirito del tempo e le mode passeggero, per offrire soluzioni che durano nel tempo grazie alla qualità dei materiali e alla loro aderenza a principi di buon design che non passeranno mai di moda.

Agape Elements è un vocabolario attentamente curato dell'architettura del bagno. Molto più della somma delle sue parti, esso è lo strumento fondamentale per aiutarvi a disegnare soluzioni complete, one-stop per quello che rimane ancora oggi la parte più intima del paesaggio domestico contemporaneo.

Washbasins / Lavabi

So many different shapes to meet practical needs and give an individual look to the entire bathroom. A variety of materials for getting back in touch with nature each day or experiencing new sensations. All this with maximum assurance of quality and durability: guaranteed by Agape's experience.

Tante forme diverse per soddisfare le esigenze pratiche e caratterizzare esteticamente l'intera stanza da bagno. Una varietà di materiali per ritrovare un quotidiano contatto con la natura, oppure per sperimentare nuove sensazioni. Tutto questo con la massima sicurezza di qualità e durata: garantisce l'esperienza Agape.



	column / a colonna	wall mounted / a parete	over countertop / da appoggio	semi-recessed / a semincasso	integrated / integrati nel piano
661			p. 10		
815		p. 11			
Bjhon 1	p. 12 ☀		p. 14 ☀		
Bjhon 2	p. 16 ☀		p. 18 ☀		
Bucatini		p. 19			
Carrara		p. 20 ☀	p. 21 ☀		
Cheese		p. 22			
Cube		p. 23	p. 23		
Deep			p. 24		
DR					p. 26
Drop	p. 30		p. 32		
Ell					p. 34
Handwash		p. 40 ☀			
Immersion	p. 42		p. 44		
Lariana	p. 45		p. 49		
Lito 1	p. 53				
Lito 2	p. 54				
Lito 3	p. 55				
Litorale		p. 56			p. 60
Marsiglia		p. 62	p. 62		

	column / a colonna	wall-mounted / a parete	over countertop / da appoggio	semi-recessed / a semincasso	integrated / integrati nel piano
Neb			p. 63		
Nivis	p. 64	p. 65	p. 66		
Normal			p. 67		
Novecento XL		p. 68			
Ottocento		p. 70			p. 72
Pear		p. 76			
Pear C	p. 77				
Petra	p. 78 ☀	p. 78 ☀	p. 80 ☀		
Raso			p. 82		p. 84
Spoon			p. 86	p. 87	
Spoon XL			p. 86	p. 87	
Undici			p. 88		p. 92
Undici Inox			p. 90		p. 92
Vieques	p. 94 ☀		p. 95 ☀		



Items marked with this symbol are part of the Outdoor Collection and can also be used outdoors / Gli articoli contrassegnati con questo simbolo fanno parte della Collezione Outdoor e possono essere utilizzati anche all'esterno

661

Over countertop washbasin / Lavabo da appoggio

Made in white Ceramilux®, a modern and resistant composite material, the 661 washbasin for resting on a top has an oval shape and deep basin, with a high and slim edge. Available in polished or matt finish.

Realizzato in Ceramilux® bianco, un moderno e resistente materiale composito, il lavabo da appoggio 661 ha una forma ovale ed un profondo bacino, con bordo alto e sottile. Disponibile nella finitura lucida o opaca.

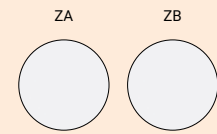
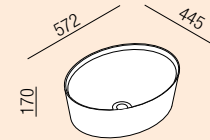
ACER0661_

design Benedini Associati, 2011

**815**

Wall mounted washbasin / Lavabo a parete

The 815 project is the fruit of the search for a dialectical relationship between the washbasin and the forms of the Plus units. The asymmetrical shape of the washbasin offers handy surface space and was designed empirically by imagining the natural erosion caused by the impact of water dripping onto marble. In its standard version made from Cristalplant® biobased white or white Carrara marble; on request available in other stones or marbles.

Il progetto 815 nasce dalla ricerca di un rapporto dialettico tra il lavabo e i volumi dei mobili Plus. La forma asimmetrica del lavabo definisce un comodo piano d'appoggio ed è ricavata in maniera empirica immaginando l'erosione naturale provocata dall'impatto delle gocce d'acqua sul marmo. Disponibile in Cristalplant® biobased bianco, in marmo bianco di Carrara o con altre pietre o marmi a richiesta.

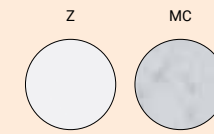
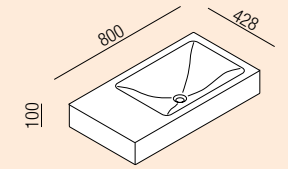
ACER0815084_MC
ACER0815084_Z

design Benedini Associati, 2012



Bjhon 1

Column washbasin / Lavabo a colonna

A. Mangiarotti

Bjhon washbasins were born from an idea of Angelo Mangiarotti in 1970. Originally conceived as a pot, Bjhon 1 freestanding is made of marble or with a technologically advanced material: Cristalplant® biobased; also available in the versions in Petit Granit marble or in Cementoskin® (colored cement paste) for outdoor use. Available with floor or wall drain version.

I lavabi Bjhon nascono da un'idea di Angelo Mangiarotti nel 1970. Originariamente concepito come fioriera, Bjhon 1 freestanding è realizzato in marmo o con un materiale tecnologicamente avanzato: il Cristalplant® biobased; disponibile anche nelle versioni in marmo Petit Granit o in Cementoskin® (cemento colorato in pasta) per utilizzo Outdoor. Disponibile con versione per scarico a pavimento o a muro.

ACER1081M_
ACER1081F_
ACER1081EM_
ACER1081EF_

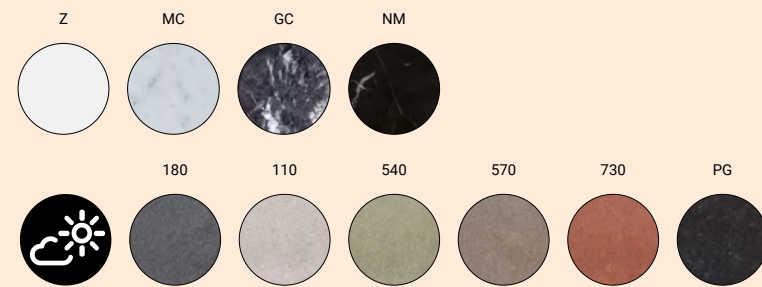
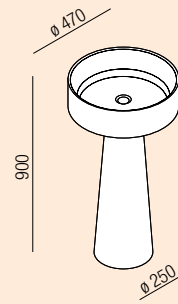

design Angelo Mangiarotti, 1970 / 2011 / 2018



Bjhon 1

Column washbasin / Lavabo a colonna

A. Mangiarotti

Bjhon 1 – washbasin / lavabo
Memory – taps / rubinetteria
Eclissi – mirror / specchio
Memory – towel holder / porta salviette



Bjhon 1

Over countertop washbasin / Lavabo da appoggio

A. Mangiarotti

Countertop version for the Bjhon 1 washbasin, an evolution of the original design by Angelo Mangiarotti from 1970. Made of marble or with a technologically advanced material: Cristalplant® biobased; also available in the versions in Petit Granit marble or in Cementoskin® (colored cement paste) for use in outdoor environments.

Versione in appoggio per il lavabo Bjhon 1, evoluzione del disegno originale di Angelo Mangiarotti del 1970. Realizzato in marmo o con un materiale tecnologicamente avanzato: il Cristalplant® biobased; disponibile anche nelle versioni in marmo Petit Granit o in Cementoskin® (cemento colorato in pasta) per utilizzo in ambienti esterni.

ACER1083_
ACER1083E_

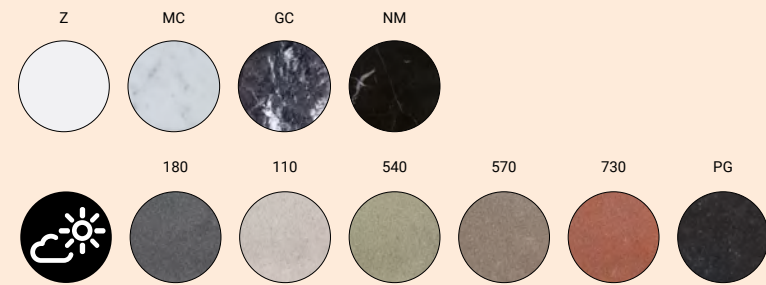
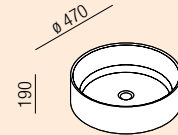

design Angelo Mangiarotti, 1970 / 2011 / 2018



Bjhon 1

Over countertop washbasin / Lavabo da appoggio

A. Mangiarotti

Bjhon 1 – washbasin / lavabo
Flat XL – countertop / piano
Lato – storage unit / contenitore
Memory – taps / rubinetteria
Eclissi – mirror / specchio
Memory – shelf / mensola



Bjhon 2

Column washbasin / Lavabo a colonna

A. Mangiarotti

With its sensually curved basin and its truncated conical column, Bjhon 2 becomes an object of strongly sculptural value. Made of marble or stone or with a technologically advanced material: Cristalplant® biobased or in Petit Granit marble for outdoor use. Available with floor or wall drain version.

Con il suo bacino dalle curve sensuali e la sua colonna tronco conica, Bjhon 2 diventa un oggetto di valenza fortemente scultorea. Realizzato in marmo o pietra o con un materiale tecnologicamente avanzato: Cristalplant® biobased oppure in marmo Petit Granit per utilizzo outdoor. Disponibile con versione per scarico a pavimento o a muro.

ACER1082F_
ACER1082M_
ACER1082EMPG
ACER1082FMPG

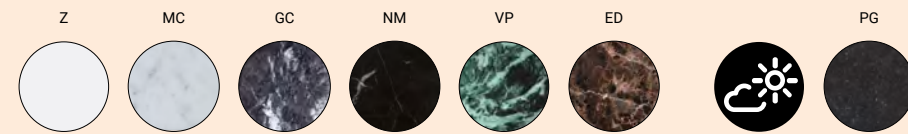
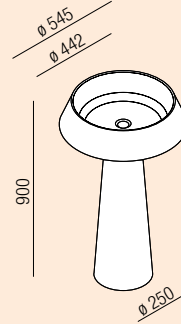

design Angelo Mangiarotti, 1970 / 2011 / 2018

**Bjhon 2**

Column washbasin / Lavabo a colonna

A. Mangiarotti

Bjhon 2 - washbasin / lavabo
Fez 2 - taps / rubinetteria
Solid - mirror / specchio

Bjhon 2

Over countertop washbasin / Lavabo da appoggio

A. Mangiarotti

Circular countertop washbasin in white Carrara marble, grey Carnic marble, black Marquina marble, green Alpi marble, Emperador dark marble, or in white Cristalplant® biobased, with cylindrical basin. The version in Petit Granit can be elegantly placed in outdoor environments.

Lavabo d'appoggio circolare in marmo bianco di Carrara, marmo grigio Carnico, marmo nero Marquina, marmo verde Alpi, marmo Emperador dark o in Cristalplant® biobased bianco, con bacino cilindrico. La versione in Petit Granit si colloca elegantemente negli ambienti esterni.

ACER1084_
 **ACER1084EPG**

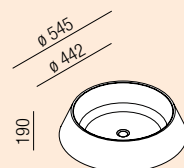

design Angelo Mangiarotti, 1970 / 2011 / 2018

**Bucatini**

Wall mounted washbasin / Lavabo a parete

Subtle irony and clever functionality for the Bucatini white ceramic washbasin, featuring side towel holders made of steel cable sheathed in white, black or transparent plastic. Bucatini can be complemented by a line of coordinating accessories. A complete range, for furnishing the bathroom with unique style.

Sottile ironia e intelligente funzionalità per il lavabo in ceramica bianca Bucatini, dotato di porta salviette laterali in cavo d'acciaio rivestito in plastica bianca, nera o trasparente. Bucatini può essere affiancato da una linea di accessori coordinati. Un programma completo per arredare il bagno con uno stile unico.

ACER0740N_
ACER0740NR_

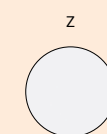
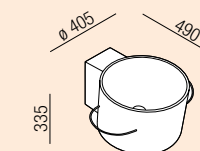

design Ermanno Righi, Fabio Bortolani, 2000



Carrara

Wall mounted washbasin / Lavabo a parete

From white Carrara marble, an eternal material of art and architecture, comes this washbasin with a large basin and thin edges, supported by a stainless steel structure. Together with the other elements of the Agape collection, the Carrara washbasin contributes to the creation of an elegant and rigorous environment, in which to surround yourself with simple and refined shapes. Available not only in white Carrara marble but also in grey Carnic, black Marquina, Verde Alpi or dark Emperador. The version in Petit Granit fits with elegance and rigor in outdoor environments.

Dal marmo bianco di Carrara, eterno materiale d'arte e architettura, nasce questo lavabo dall'ampio bacino e dai bordi sottili, sostenuto da una struttura in acciaio inox. Insieme agli altri elementi della collezione Agape, il lavabo Carrara contribuisce a determinare un ambiente elegante e rigoroso, nel quale circondarsi di forme semplici e raffinate. Disponibile, oltre che in marmo bianco di Carrara anche in grigio Carnico, nero Marquina, verde Alpi o Emperador dark. La versione in Petit Granit si inserisce con eleganza e rigore negli ambienti esterni.

ACER0730S_
ACER0730ESPG

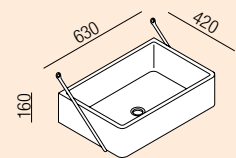

design Benedini Associati, 1999 / 2019



Carrara

Over countertop washbasin / Lavabo da appoggio

Rectangular washbasin in the countertop version, characterized by a large basin and thin edges. Available in different types of marble, the Petit Granit version allows it to be placed outdoors in the most different contexts, qualifying them with their own elegance and rigor.

Lavabo rettangolare caratterizzato dall'ampio bacino e dai bordi sottili. Disponibile in diversi tipi di marmo, la versione in Petit Granit ne permette la collocazione in ambienti esterni e nei contesti più diversi qualificandoli con la propria eleganza e rigore.

ACER0730P_
ACER0730EPPG

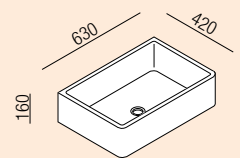

design Benedini Associati, 1999 / 2019



Cheese

Wall mounted washbasin / Lavabo a parete

Cheese, a white ceramic washbasin, has a full-bodied yet compact shape, ideal for a small bathroom with a great personality.

Il lavabo in ceramica bianca Cheese ha una forma piena e compatta, ideale per un piccolo bagno dalla grande personalità.

ACER0710NZ
ACER0710NRZ

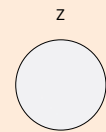
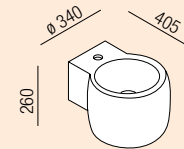

design Benedini Associati, 1999



Cube

Wall mounted and over countertop washbasin / Lavabo a parete e da appoggio

Solid shape and natural warmth for Cube, a plywood washbasin realised in natural, brown or dark oak or in reconstituted wood, with teak finish. The large side surfaces show off the grain of the wood. Cube, available in the wall-mounted or over countertop version, can be integrated with other elements in oak or teak, playing with the lines, volumes and natural sensations, to create solutions with great warmth and appeal.

Volume massiccio e calore naturale per Cube, il lavabo in multistrato con finitura in rovere naturale, bruno, scuro o in legno precomposto con finitura teak. Le ampie superfici laterali fanno apprezzare le venature del legno. Cube, disponibile nella versione a parete o da appoggio su piano, può essere integrato con altri elementi in rovere o teak giocando con linee, volumi e sensazioni naturali, per dare vita a soluzioni ricche di fascino e calore.

ACER0770M_
ACER0770P_

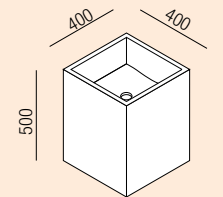

design Benedini Associati, 2003



Deep

Over countertop washbasin / Lavabo da appoggio

The Deep washbasin with a deep and enveloping design, is able to characterise any composition with a distinctive style. In white Cristalplant® biobased.

Il lavabo Deep con un design profondo e avvolgente, caratterizza con uno stile inconfondibile qualsiasi composizione. Realizzato in Cristalplant® biobased bianco.

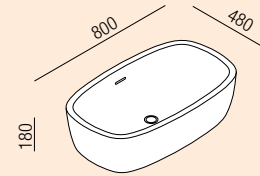
ACER0800Z

design Benedini Associati, 2003

**Deep**

Over countertop washbasin / Lavabo da appoggio

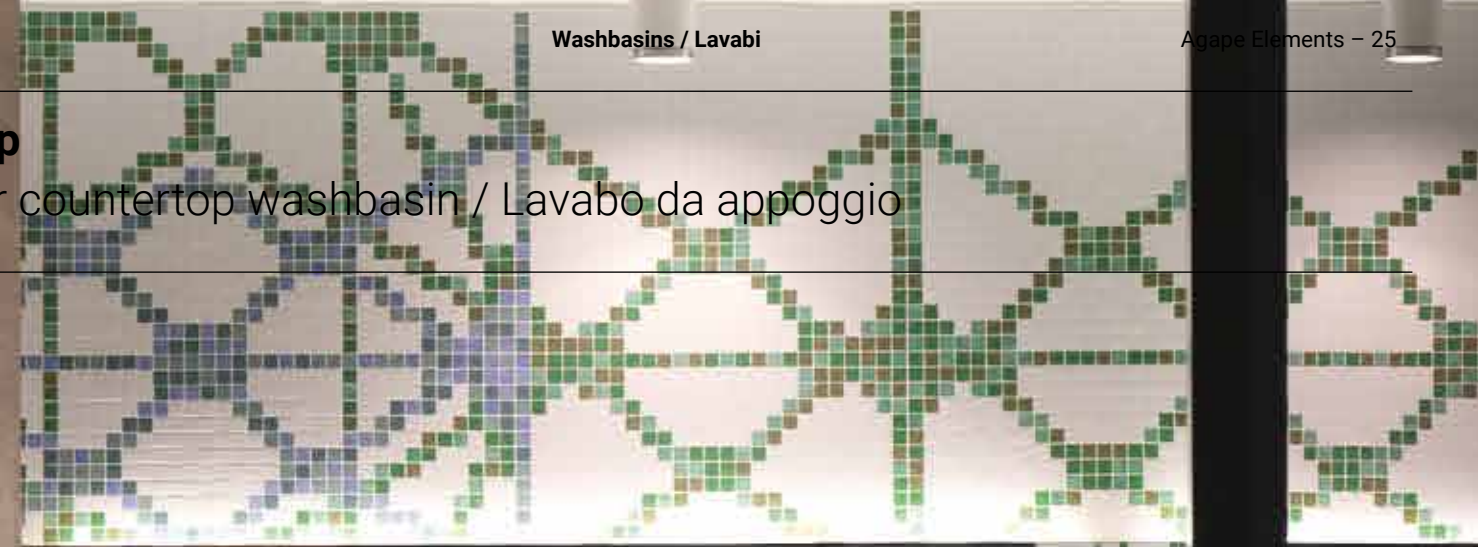

Deep – washbasin / lavabo
 Flat XL – countertop / piano
 Memory – taps / rubinetteria

DR

Integrated washbasin / Lavabo integrato nel piano

The DR washbasin top, designed by Studio MK27, Marcio Kogan and Mariana Ruzante, is distinguished by both its refinement and the quality of its details, characteristics that mark all the projects of this Brazilian architecture studio. The washbasin is framed on three sides by metal plates. The basin has a rectangular shape and is integrated into the marble top with its drain hidden by a slab made of the same material. It can be placed either in the centre, to the right or to the left. DR is available in lengths ranging from 120 to 220 cm and comes with one or more drawers placed under the top in the basin's free area for lengths exceeding 140 cm. The front of the drawers adopts the Lato system materials and finishes to respond to the most varied aesthetic needs.

Il piano-lavabo DR è contraddistinto dalla ricercatezza e qualità dei suoi dettagli, principi alla base dei progetti architettonici dello studio brasiliano. Il lavabo è incorniciato su tre lati da lastre di metallo. L'invase, integrato nel piano in marmo con lo scarico nascosto da una lastra dello stesso materiale, ha una forma rettangolare e può essere posizionato al centro, a destra o a sinistra. Disponibile con lunghezze che vanno dai 120 ai 220 cm, per le dimensioni superiori ai 140 cm, DR prevede uno o più cassetti sottopiano collocati nella zona libera dal catino. I frontali dei cassetti, riprendono i materiali e le finiture disponibili per il sistema Lato permettendo al lavabo di rispondere alle più diverse esigenze estetiche.

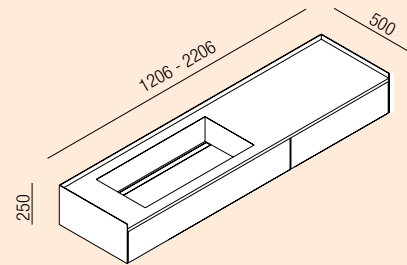
ADRP_

design Studio MK27, Mariana Ruzante,
Marcio Kogan, 2018

**DR**

Integrated washbasin / Lavabo integrato nel piano



DR – integrated washbasin / lavabo integrato nel piano
Memory – taps / rubinetteria
Narciso – mirror / specchio
Memory – accessories / accessori

DR

Integrated washbasin / Lavabo integrato nel piano

Top finish / Finitura piano

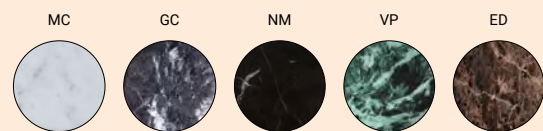

Side and backsplash finish / Finitura fianchi e alzata



Drawer front finish / Finitura frontale

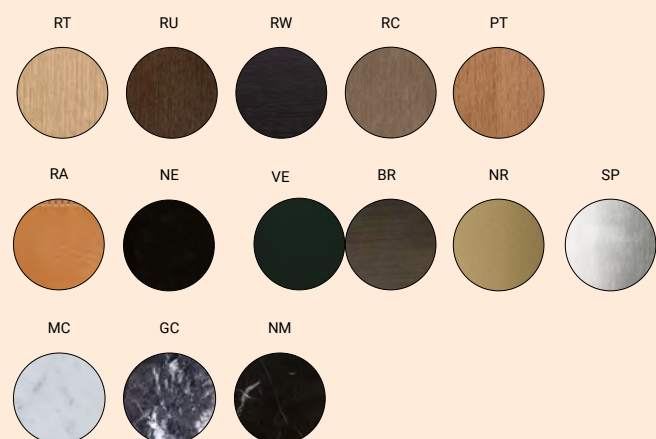

Casing finish / Finitura cassa

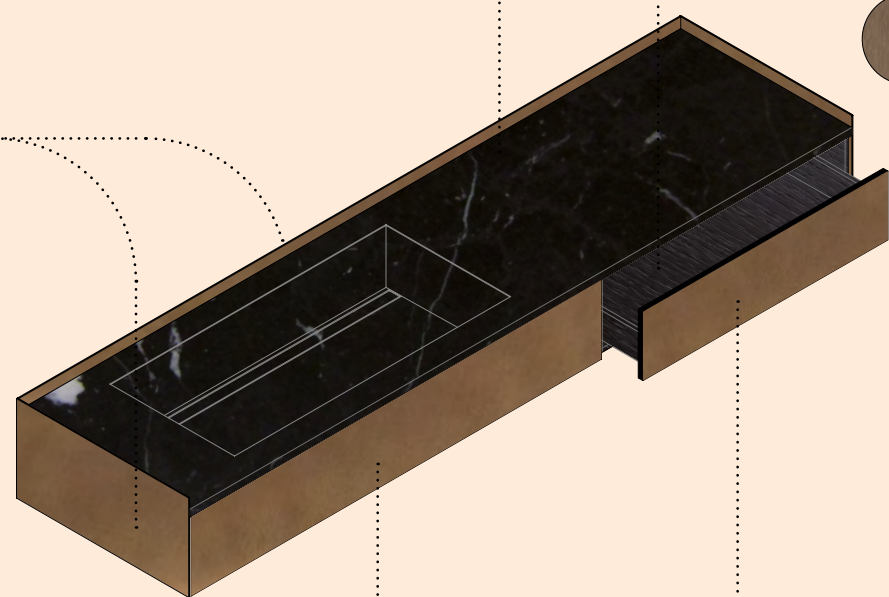

DR

Integrated washbasin / Lavabo integrato nel piano

The diagram indicates all the possible DR configurations, plus the front panel sizes. The front panel in line with the washbasin is fixed, the sides are drawers.

Nello schema sono riportate tutte le configurazioni possibili di DR e sono indicate le dimensioni dei frontali. Il frontale in corrispondenza del lavabo è fisso, i laterali sono cassetti.

Washbasin on the left / Lavabo a sinistra

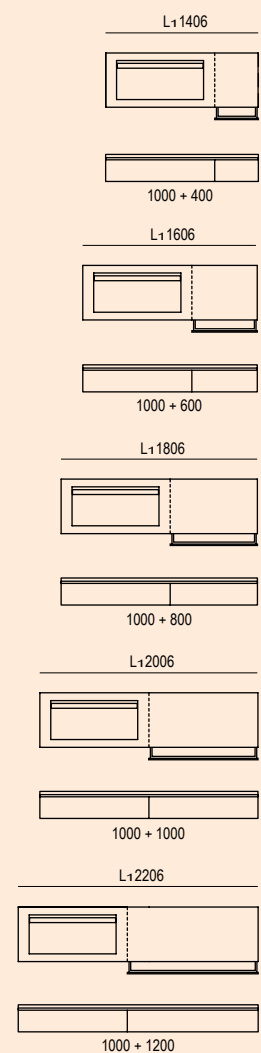

Washbasin on the centre-left / Lavabo a centro sinistra



Centred washbasin / Lavabo centrale

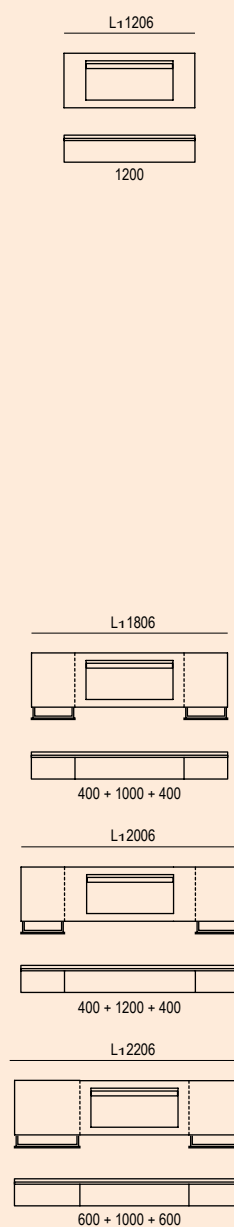

Washbasin on the centre-right / Lavabo a centro destra



Washbasin on the right / Lavabo a destra

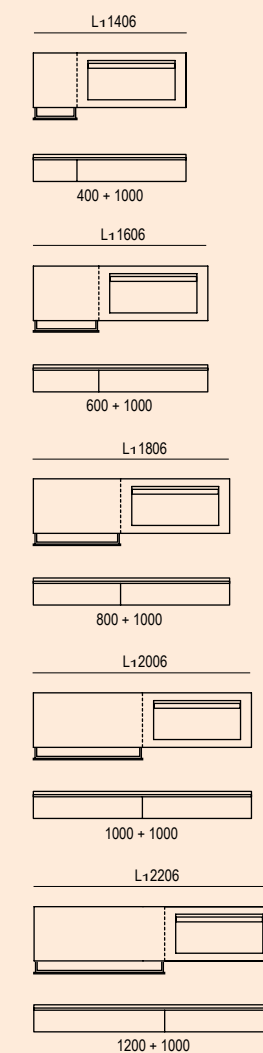

Drop

Column washbasin / Lavabo a colonna

The Drop washbasin reminds the design of the tub of the same name, in harmony with a dynamic and unconventional style in the bathroom. The column version allows wall mounting or island positioning. The choice of materials is wide and emotionally rich: from Cristalplant® biobased to white Carrara marble, grey Carnic, black Marquina, verde Alpi or Emperador dark marble. The washbasin can also be supplied in stone or marble at the customer's request. Available with floor or wall drain version.

Il lavabo Drop riprende il disegno dell'omonima vasca, in sintonia con uno stile dinamico e anticonvenzionale nell'ambiente bagno. La versione a colonna permette fissaggio a muro o posizionamento ad isola. Ampia e ricca di emozioni materiche la scelta dei materiali: dal Cristalplant® biobased ai marmi bianco di Carrara, grigio Carnico, nero Marquina, verde Alpi o Emperador dark. Il lavabo può essere fornito anche in pietre o marmi a richiesta del cliente. Disponibile con versione per scarico a pavimento o a muro.

ACER1099M_
ACER1099F_

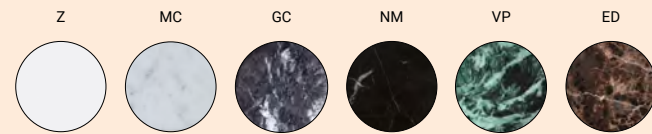
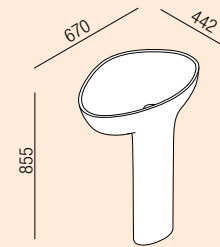

design Benedini Associati, 2014



Drop

Column washbasin / Lavabo a colonna

Drop – washbasin / lavabo
Sen – taps / rubinetteria
Narciso – mirror / specchio
Sen – accessories / accessori



Drop

Over countertop washbasin / Lavabo da appoggio

Generously sized washbasin in the countertop version and in multiple finishes: from Cristalplant® biobased to white Carrara marble, grey Carnic, black Marquina, Verde Alpi or Emperador dark marble. The washbasin can also be supplied in stone or marble at the customer's request. Available in two different widths: 63,3 cm and 67 cm.

Lavabo dalle dimensioni generose in versione da appoggio disponibile in molteplici finiture: dal Cristalplant® biobased ai marmi bianco di Carrara, grigio Carnico, nero Marquina, verde Alpi o Emperador dark. Il lavabo può essere fornito anche in pietre o marmi a richiesta del cliente. Disponibile in due diverse larghezze, cm 63,3 e cm 67.

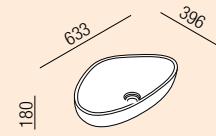
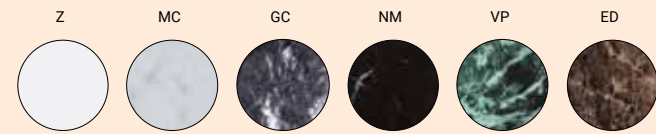
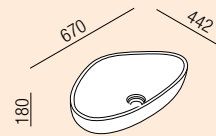
ACER1098_**ACER1098L_**

design Benedini Associati, 2014

**Drop**

Over countertop washbasin / Lavabo da appoggio

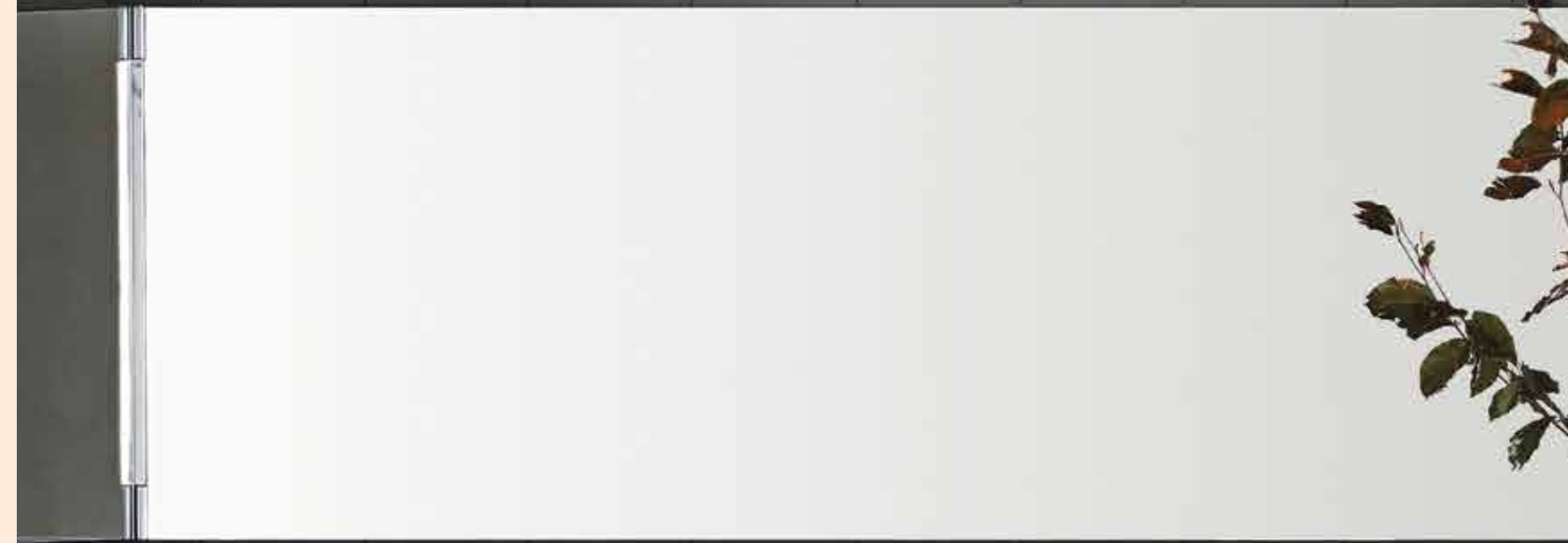

Drop – washbasin / lavabo
 Flat XL programme / programma
 Square-taps / rubinetteria
 Narciso – mirror / specchio

EII

Integrated washbasin / Lavabo integrato nel piano

EII is a washbasin countertop program characterized by a light design and high configurability. EII is made in white Corian® (Glacier White) or in white Carrara, grey Carnic, black Marquina, Verde Alpi or Emperador dark marble. Upon request, and after technical evaluation, other colors of Corian® and types of marble are possible. The self-supporting version enhances the elegance of EII which appears suspended thanks to the support of simple brackets and a thickness reduced to only 38,5 mm. Available with a minimum length of 80 cm and a maximum of 260 cm, the basin recess is 60 cm wide. The basins can be freely positioned along the entire length of the top and come complete with gridded covers. This version of EII can also be completed with dedicated splash-back panels in the same materials.

EII è un programma di piani lavabo caratterizzato dal segno leggero e dalla elevata configurabilità. EII è realizzato in Corian® bianco (Glacier White) oppure in marmo bianco di Carrara, grigio Carnic, nero Marquina, verde Alpi o Emperador dark. Su richiesta, e dopo valutazione tecnica, sono possibili altre colorazioni di Corian® e tipi di marmi. La versione autoportante esalta l'eleganza di EII che appare sospeso grazie al sostegno di semplici staffe ed uno spessore ridotto a soli 38,5 mm. Disponibile con lunghezza minima di cm 80 e massima di cm 260, l'invaso del lavabo è largo cm 60. Gli invasi sono liberamente posizionabili su tutta la lunghezza del piano e sono completi di griglia. EII autoportante può essere completato da alzate dedicate in materiale coordinato.

AELLNO_1_
AELLNO_2_
AELLNO_3_

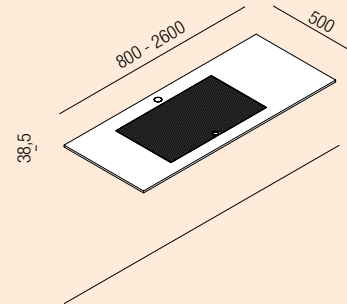

Winner "THE BEST INTERIOR PRODUCTS" 2016

design Benedini Associati, Diego Cisi,
Andrés Jost, 2015

**EII**

Integrated washbasin / Lavabo integrato nel piano

EII – integrated washbasin / lavabo integrato nel piano
Bucatini – toothbrush holder / porta spazzolini



EII

Integrated washbasin / Lavabo integrato nel piano

The EII range is completed by the countertop version over Lato containers available in the same materials of the self-supporting configuration. This variant is also available with a minimum length of 80 cm and a maximum of 260 cm with basins that can be freely positioned along the entire length of the top, respecting the distances from the edges and that between the basins. This version can also be completed with splash-back panels in the same materials.

Il programma EII è completato dalla versione da appoggio su contenitori Lato. I materiali sono gli stessi materiali della versione autoportante. Anche questa versione è disponibile con lunghezza minima di cm 80 e massima di cm 260 con invasi liberamente posizionabili su tutta la lunghezza del piano, rispettando le distanze dai bordi e quella tra gli invasi completi di griglia e può essere completato da alzate dedicate in materiale coordinato.

AELLMOCC1_
AELLMOCC2_
AELLMOCC3_

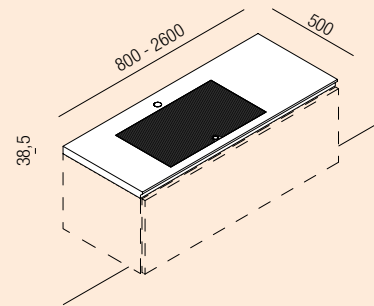

design Benedini Associati, Diego Cisi,
Andrés Jost, 2015

**EII**

Integrated washbasin / Lavabo integrato nel piano



EII – integrated washbasin / lavabo integrato nel piano
Memory – taps / rubinetteria
Lato – programme / programma
Memory – shelf / mensola
Puzzle – extras / complementi

EII

Integrated washbasin / Lavabo integrato nel piano

Top and splash-back panels finish /
Finitura piano e alzata

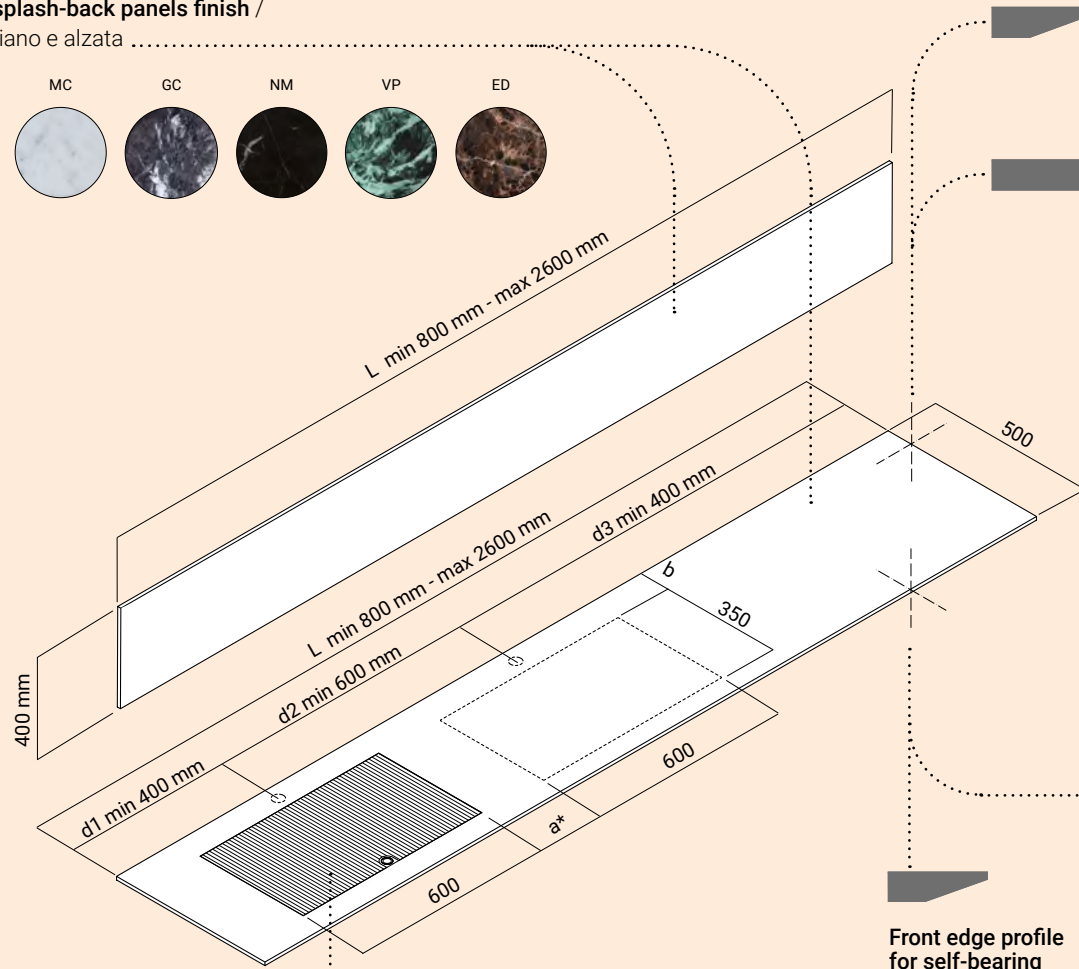
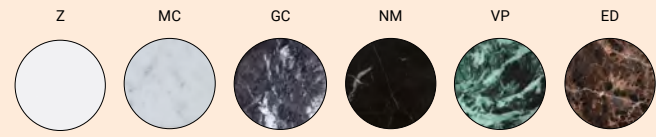

Lateral edge profile for
self-bearing countertop /
Profilo del bordo laterale
per piani autoportanti

Lateral edge profile for
self-bearing in niche
countertop and for
countertop in support /
Profilo del bordo laterale
per piani autoportanti
in nicchia e per piani da
appoggio

Front edge profile
for self-bearing
countertop / Profilo
del bordo frontale per
piani autoportanti

Front edge profile
for countertop in
support / Profilo del
bordo frontale per
piani da appoggio

Grill finish / Finitura griglia

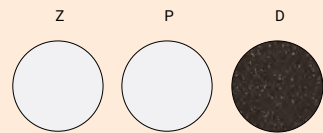

b mm 90 or mm 50 (only for Fez 2 AFEZ011 and Sen
ASEN0912HS wall mounted taps) / b mm 90 o mm
50 (solo per rubinetti a parete Fez 2 AFEZ01 e Sen
ASEN0912HS)

* The washbasins can also be placed alongside each
other / I lavabi possono anche essere affiancati
a = 0

Top finish / Finitura piano	Grill finish / Finitura griglia		
	Z. Glacier White	P. Limestone Prima	D. Deep Caviar
Z. Corian® (Glacier White) white / bianco	●		
Y. Carrara white marble / marmo bianco Carrara		●	
K. Carnic grey marble / marmo grigio Carnico			●
E. Marquina black marble / marmo nero Marquina			●
V. green Alpi marble / marmo verde Alpi			●
D. dark Emperador marble / marmo Emperador dark			●

EII

Integrated washbasin / Lavabo integrato nel piano

EII – integrated washbasin / lavabo integrato nel piano

Memory – taps / rubinetteria
Lato – storage unit / contenitore
Narciso – mirror / specchio
Spai – mirror / specchio



Handwash

Wall mounted washbasin / Lavabo a parete

This compact, squareshaped hand basin in white Cristalplant® biobased is perfect for installation in any type of space, giving it a unique stylish look. Without side storage compartment, it can be combined with wall-mounted or single-hole tap fittings. The version in Cementskin® (coloured concrete in paste) allows also its outdoor use, even in small ambiances.

Compatto e squadrato, questo lavamani in Cristalplant® biobased bianco si presta ad essere inserito in qualsiasi spazio, caratterizzandolo con uno stile speciale. Con o senza vano portaoggetti laterale, può essere abbinato a rubinetteria a parete o monoforo. La versione in Cementskin® (cemento colorato in pasta) ne permette l'utilizzo anche in ambienti esterni, anche di piccole dimensioni.

ACER09940RZ
ACER09941RZ

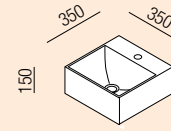

ACER09950RZ
ACER09951RZ
ACER09950RE

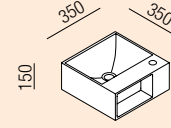

design Benedini Associati, 2010 / 2018



Handwash

Wall mounted washbasin / Lavabo a parete

Handwash – washbasin / lavabo
Square – taps / rubinetteria
Fusilli – mirror / specchio
Mach 2 – towel holder / porta salviette



Immersion

Column washbasin / Lavabo a colonna

The Immersion washbasin, with a matt black-coated floor-standing metallic support, is the ideal complement for the bathtub of the same name, inspired by the tradition of oriental timber bathing vessels.

The compact size of this washbasin makes it suitable for confined living spaces as well. Made of Cristalplant® Biobased, all the versions are available in matt white or two-colour finish in dark or light grey.

The wall-mounted version is furnished with a rear slot for water connections. Available with floor or wall drain version.

Il lavabo Immersion, con supporto metallico verniciato in nero opaco per appoggio a terra, diventa il complemento ideale dell'omonima vasca, ispirata alle tradizionali tinozze di legno orientali. Il suo ingombro ridotto lo rende adatto anche ad ambienti di piccole dimensioni. Realizzato in Cristalplant® biobased, tutte le versioni del lavabo sono disponibili in bianco opaco o bicolore grigio scuro o chiaro.

Il modello per l'utilizzo a parete è dotato di apertura posteriore per i collegamenti idrici. Disponibile con versione per scarico a pavimento o a muro.

ACER0708P
ACER0709PE
ACER0709E

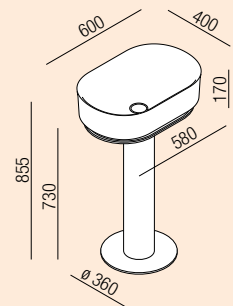

Winner "NYCxDESIGN AWARD" 2020

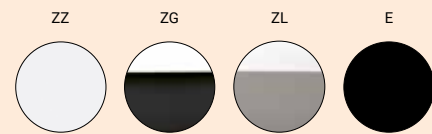

design Neri&Hu, 2018



Immersion

Column washbasin / Lavabo a colonna

Immersion – washbasin / lavabo

Sen – taps / rubinetteria

Memory – mirror / specchio

Dot line – towel holder / porta salviette

Sen – accessories / accessori



Immersion

Over countertop washbasin / Lavabo da appoggio

Countertop washbasin with delicate shape and reduced dimensions that allows it to be used even in small rooms. Made of Cristalplant® biobased, all versions of the washbasin are available in matt white or two-tone dark or light grey.

Lavabo dalla forma morbida e di dimensioni ridotte, in appoggio su piano, adatto anche per piccoli ambienti. Realizzato in Cristalplant® biobased, tutte le versioni del lavabo sono disponibili in bianco opaco o bicolore grigio scuro o chiaro.

ACER0708P_

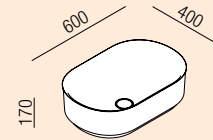

Winner "NYCxDESIGN AWARD" 2020

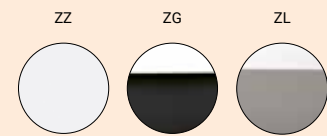

design Neri&Hu, 2018



Lariana

Column washbasin / Lavabo a colonna

The family of Lariana bathroom elements is characterized by a harmonious juxtaposition of geometric and fluid lines, which is also matched by the possibility of combining different materials: from Cristalplant® biobased, to marble in different shades, to wood. The washbasin Lariana column is composed of a soft basin that rests on a monolithic base; both can be made in Cristalplant® biobased or in marble in different finishes; column is also available in oak in the usual finishes or in lacquered wood with open pore. Lariana can be completed with a storage unit in natural, brown, dark oak or in pre-composed wood with teak finish and with a storage shelf in the same oak or iroko finishes, both the accessories can be in lacquered wood open pore finishes. Lariana can be combined with the containers of the Lato or Flat XL programs. Available with floor or wall drain version.

La famiglia degli elementi per il bagno Lariana è caratterizzata da un'armoniosa contrapposizione di linee geometriche e fluide, al quale fa riscontro anche la possibilità di abbinare diversi materiali: dal Cristalplant® biobased, al marmo in diverse tonalità, al legno. Il lavabo Lariana a colonna è composto da un morbido bacino che appoggia su un monolitico basamento; entrambi possono essere realizzati in Cristalplant® biobased o in marmo in diverse finiture; la colonna è disponibile anche in rovere nelle consuete finiture o con laccatura a poro aperto. Lariana può essere completato con un mobile contenitore in rovere naturale, bruno, scuro o in legno precomposto con finitura teak e da una mensola portaoggetti nelle stesse finiture rovere o in iroko, entrambi gli accessori possono essere laccati a poro aperto. Lariana può essere affiancato dai contenitori dei programmi Lato o Flat XL. Disponibile con versione per scarico a pavimento o a muro.

design Patricia Urquiola, 2017



Lariana

Column washbasin / Lavabo a colonna

Basin for support / Lavabo per supporto

ACER1073_

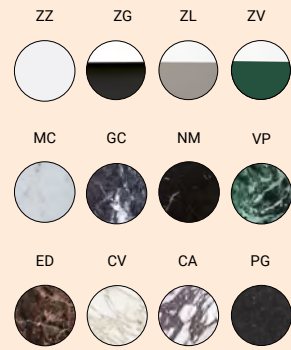
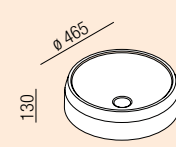

Storage shelf / Mensola porta oggetti

ACER1127_

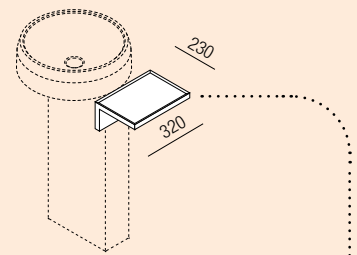

Washbasin support / Supporto per lavabo

ACER1126_

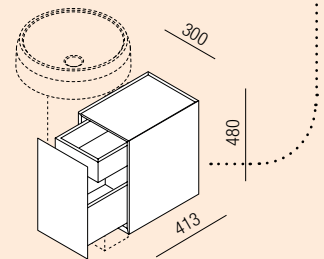
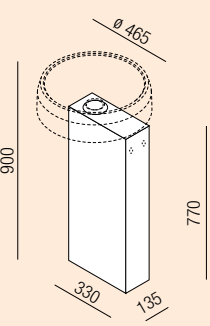

Storage unit / Contenitore

ALEG1128_



Cristalplant® and wood / Cristalplant® e legno

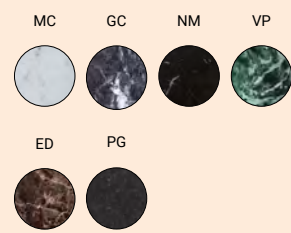
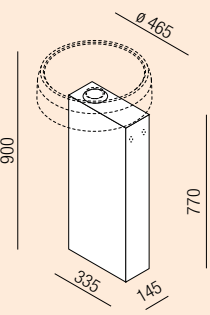

Marble / Marmo

Lariana

Column washbasin / Lavabo a colonna

Lariana – washbasin / lavabo

Square – taps / rubinetteria

Solid – mirror / specchio

Costellation – toothbrush holder / porta spazzolini



Lariana

Column washbasin / Lavabo a colonna

With Lariana shelf / Con mensola Lariana

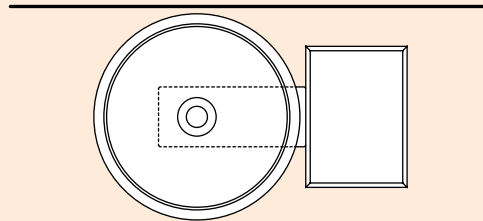

The Lariana shelf is fixed to the left or right support when this one is parallel to the wall / La mensola Lariana viene fissata al supporto a destra o a sinistra del lavabo quando questo è posto parallelo alla parete

With Lariana storage unit / Con contenitore Lariana

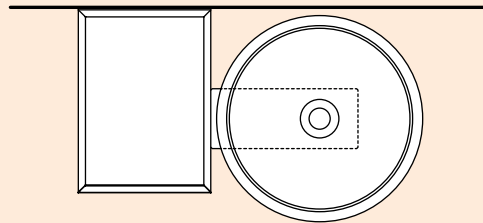

The Lariana storage unit is fixed to the left or right support when this one is parallel to the wall. The Flat XL and Lato containers can also be combined with this support / Il contenitore Lariana viene fissato al supporto a destra o a sinistra del lavabo quando questo è posto parallelo alla parete. Possono essere affiancati al supporto anche i contenitori dei programma Flat XL e Lato

With Flat XL or Lato storage unit / Con contenitore Flat XL o Lato

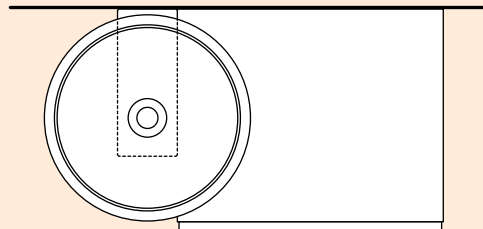

The support can also be positioned perpendicular to the wall, this allows you to use also the Flat XL and Lato containers / Il supporto può essere posizionato anche perpendicolarmente alla parete, questo permette l'accostamento dei contenitori dei programma Flat XL e Lato.

Discover the Flat XL or Lato collection storage units at page 370 and page 376 / Scopri i contenitori della collezione Flat XL e Lato a pagina 370 e pagina 376

Lariana

Over countertop washbasin / Lavabo da appoggio

Round, oval or rectangular over countertop basin in Cristalplant® biobased, characterised by the distinctive contrast between the soft, curved-shaped bowl and the linear, geometric form of the outside. Available either in white or two colours with a light grey exterior, dark grey or Pine green, in white Carrara, grey Carnic, black Marquina, green Alpi, Emperador dark and Petit Granit marble.

Lavabo d'appoggio tondo o ovale in Cristalplant® biobased o rettangolare con spigoli arrotondati in solid surface caratterizzato dalla morbida curvatura dell'invaso che si oppone alla sagoma lineare dell'esterno. Disponibile nelle finiture bianco o bicolore con esterno grigio chiaro, grigio scuro o verde pino, oppure in marmo bianco di Carrara, grigio Carnico, marmo nero Marquina, verde Alpi, Petit Granit e Emperador dark.

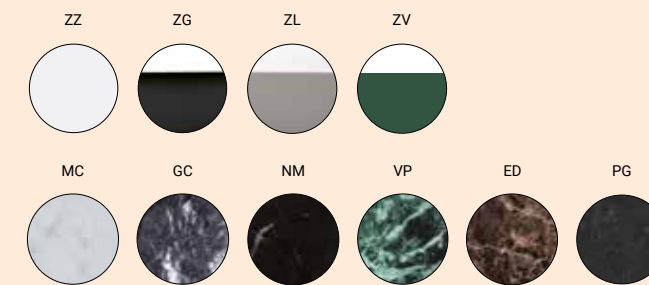

ACER1073_

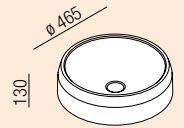

ACER1074_

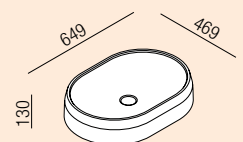

ACER1075_

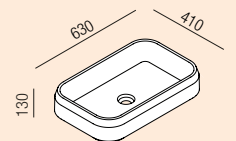

design Patricia Urquiola, 2017



Lariana

Over countertop washbasin / Lavabo da appoggio

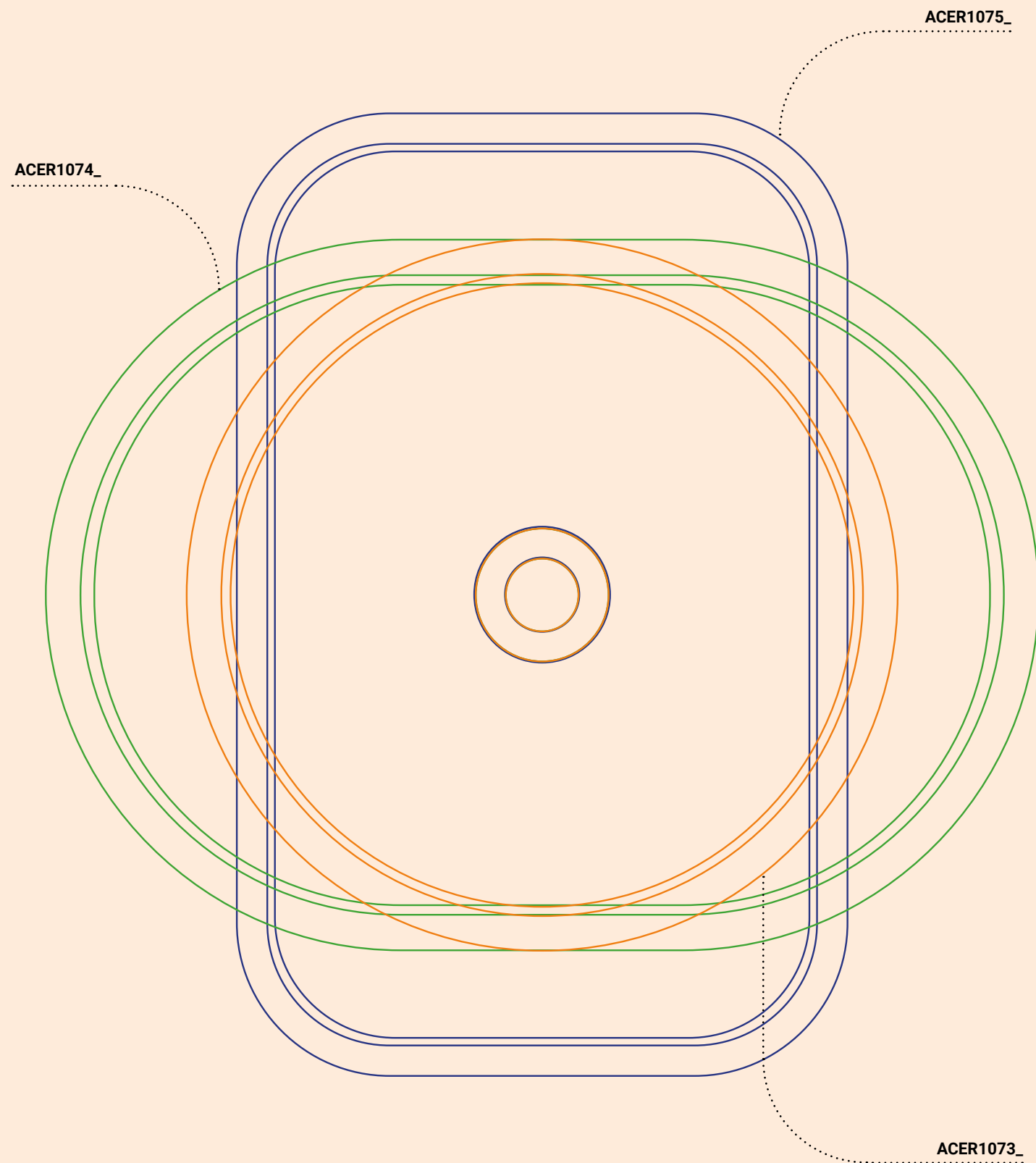

Lariana

Over countertop washbasin / Lavabo da appoggio



Lariana – washbasin / lavabo
Flat XL – countertop / piano
Square – taps / rubinetteria

Lito

Column washbasin / Lavabo a colonna

A. Mangiarotti

United by the sculptural aspect of their shapes and by the elegance of the material - white Carrara marble - the Lito washbasins then take on distinctive characteristics.

Lito 1 is made entirely from the excavation of a block of marble: its inverted 'L' shape makes it possible to obtain two pieces from each block with a maximum reduction of the waste of material. It is only intended for wall mounting.

Lito 2 with its imposing and at the same graceful geometry transcends the mere functional characteristic for which it was designed. Column positioning.

Lito 3, on the other hand, takes on more rigorous and still elegant lines, it only provides wall fixing. Lito washbasins can be made of stone or marble on request.

Accomunati dall'aspetto scultoreo delle loro forme e dall'eleganza del materiale - marmo bianco di Carrara - i lavabi Lito assumono poi caratteristiche distinte.

Lito 1 è realizzato interamente dall'escavazione di un blocco di marmo: la sua forma ad 'L' rovesciata permette di ricavare due pezzi da ogni blocco con una riduzione al massimo dello spreco di materiale. E' previsto solo per fissaggio a parete.

Lito 2 con la sua geometria imponente e allo stesso aggraziata trascende la mera caratteristica funzionale per cui è stato disegnato. Posizionamento a colonna.

Lito 3 assume invece linee più rigorose e pur sempre eleganti, prevede il solo fissaggio a parete. I lavabi Lito possono essere realizzati in pietre o marmi a richiesta.

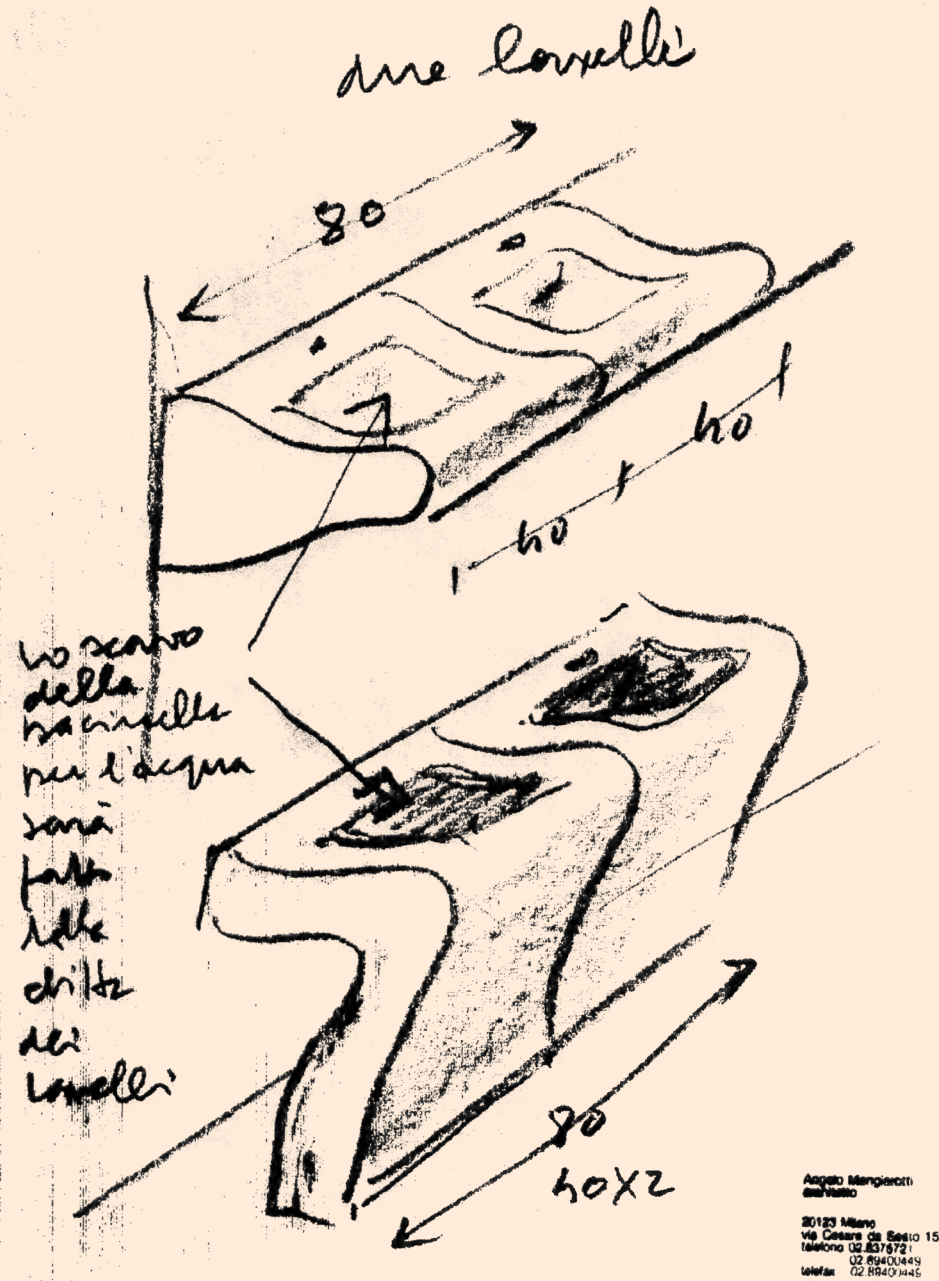

Lito 1

Column washbasin / Lavabo a colonna

A. Mangiarotti

Entirely carved from a single block of marble, Lito 1 takes the form of an upside down "L" with a particularly gently dished bowl. The personality of an internationally famous architect and designer transforms the bathroom into an avant-garde design. Made of white Carrara marble, the washbasin can be delivered also in stone or marble types on demand.

Realizzato interamente dall'escavazione di un blocco di marmo, Lito 1 è caratterizzato da una forma ad "L" rovesciata e da una conca particolarmente morbida. La personalità di un protagonista dell'architettura e del design mondiale, trasforma lo spazio bagno in un progetto all'avanguardia. Realizzato in marmo bianco di Carrara, il lavabo può essere fornito anche in pietre o marmi a richiesta del cliente.

ACER0731

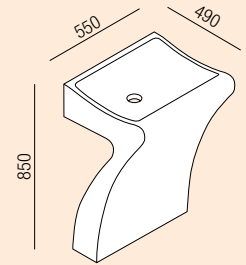

design Angelo Mangiarotti, 2003



Lito 2

Column washbasin / Lavabo a colonna

A. Mangiarotti

Realised in white Carrara marble, Angelo Mangiarotti's design takes the form of a hand basin designed with the skill of a true master. Lito 2 is far more than a simple furnishing accessory, without losing sight of functional characteristics it is intended to provide: with its ergonomic lines and ideal capacity of the basin. The washbasin can be delivered also in stone or marble types on demand.

Realizzato in marmo bianco di Carrara, il progetto di Angelo Mangiarotti prende la forma di un lavamani disegnato con la sapienza di un autentico maestro. Lito 2 va oltre la semplice dimensione di complemento d'arredo, senza trascendere le caratteristiche funzionali cui è destinato: nelle linee ergonomiche e nell'ideale capienza del bacino. Il lavabo può essere fornito anche in pietre o marmi a richiesta del cliente.

ACER0732
ACER0732R

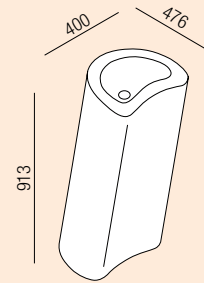

design Angelo Mangiarotti, 2003

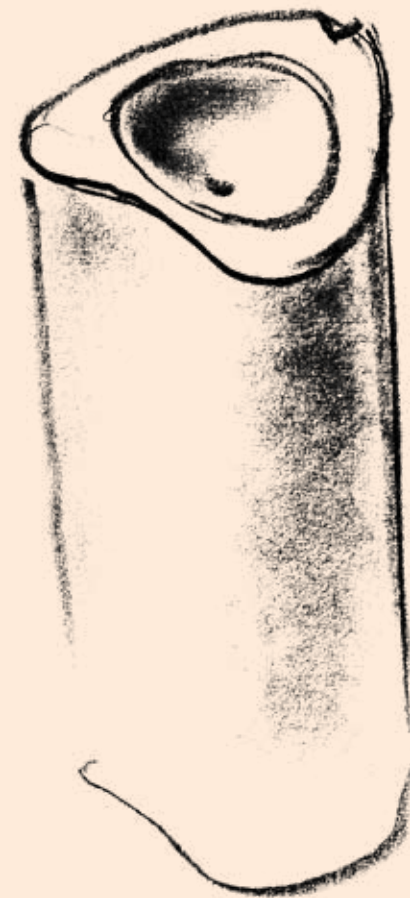
**Lito 3**

Column washbasin / Lavabo a colonna

A. Mangiarotti

Angelo Mangiarotti's design innovation brings us a further variation on the theme, with this washbasin, featuring strong, dynamic and striking lines. Lito 3's sculptural material and design transform even the smallest bathroom space into a fascinating, unique place. Made of white Carrara marble, the washbasin can be delivered also in stone or marble types on demand.

La ricerca progettuale di Angelo Mangiarotti propone un'ulteriore variazione sul tema, con questo lavabo dalle linee decise, dinamiche, emozionanti. Il design ed il materiale scultoreo di Lito 3, trasformano anche un piccolo spazio di servizio in un luogo pieno di fascino e personalità. Realizzato in marmo bianco di Carrara, il lavabo può essere fornito anche in pietre o marmi a richiesta del cliente.

ACER0733

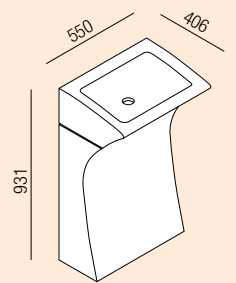

design Angelo Mangiarotti, 2003



Litorale

Wall mounted washbasin / Lavabo a parete

Litorale is a washbasin countertop with an uninterrupted linear basin available in lengths ranging from 80 to 240 cm. Only 6 cm thick, Litorale is manufactured in thermoformed solid surface and it can be equipped with a number of trays available in three different sizes (20, 40 and 60 cm) made either in iroko or in the same material as the basin itself. For lengths above 160 cm, Litorale can be equipped with two faucets. In this case, to ensure proper flow management, the basin has to be equipped with the same number of wastes.

Litorale è un piano-lavabo a canale continuo disponibile in lunghezze su misura comprese tra gli 80 e i 240 cm. Realizzato in solid surface termoformato e spesso solo 6 cm, il lungo catino dai segni lineari minimi è accessorabile con una serie di piani di appoggio liberamente posizionabili. I piani sono a catalogo in tre diverse dimensioni (20, 40 e 60 cm), in legno iroko massello oppure nello stesso materiale del lavabo. Per lunghezze superiori ai 160 cm, il piano può essere dotato di due rubinetti. In questo caso, per assicurare il corretto deflusso delle acque, a ogni rubinetto deve corrispondere uno scarico dedicato. Il lavabo permette l'installazione della rubinetteria sia sul piano che a parete.

design Benedini Associati, 2021



Litorale

Wall mounted washbasin / Lavabo a parete

Shelves finish /
Finitura piano porta oggetti

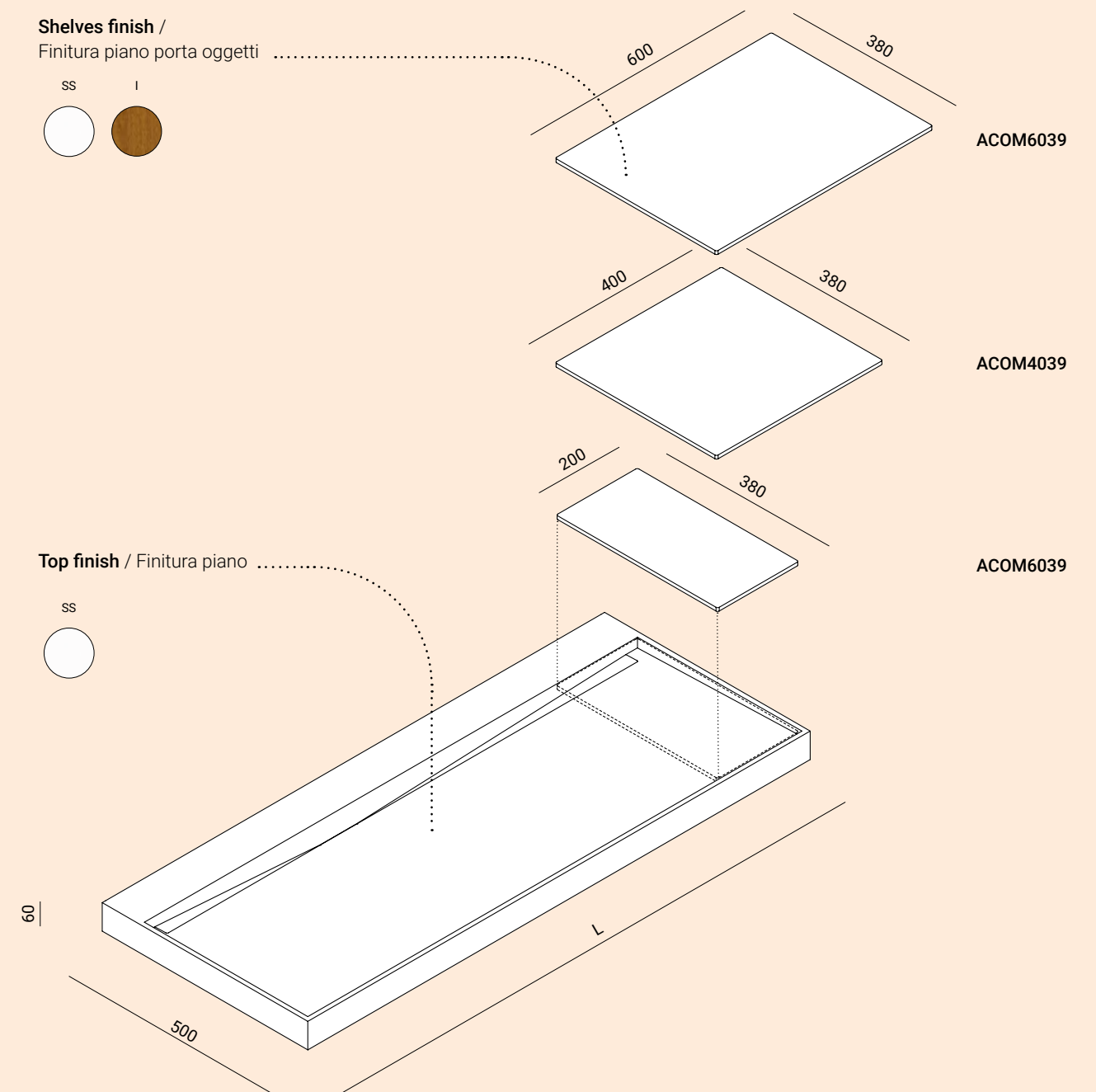

Lavabo con uno scarico, per
rubinetteria a parete o su piano
/ Lavabo con uno scarico, per
rubinetteria a parete o su piano

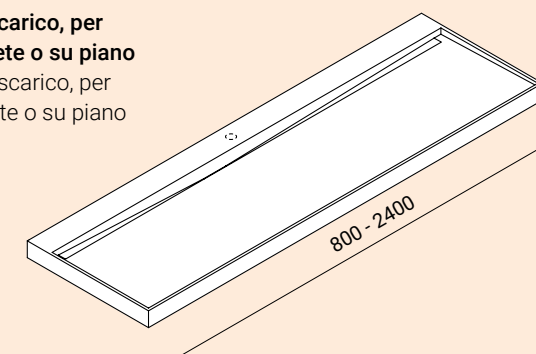

Lavabo con due scarichi, per
rubinetteria a parete o su piano
/ Lavabo con due scarichi, per
rubinetteria a parete o su piano

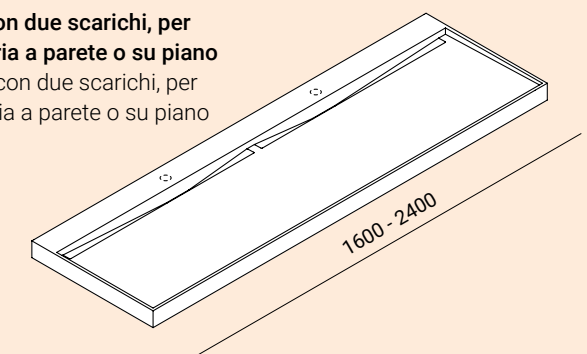

Litorale

Wall mounted washbasin / Lavabo a parete



Litorale

Wall mounted washbasin / Lavabo a parete



Litorale

Over countertop washbasin on Evo 21 / Lavabo in appoggio su Evo 21

The Litorale washbasin is also available in the over-container version in combination of the recently introduced Evo21 system.

In this version the basin has to cover the whole length of the composition. The washbasin is only 6 cm tall and inherits its dimensional range (from 80 to 240 cm) from the self-bearing, wall-mounted version. The same goes for the possibility of adding trays in three different lengths (20, 40 and 60 cm) in two different materials (white solid surface and iroko wood). For further details please refer to the section dedicated to Evo21 in the Agape Systems catalog.

Il lavabo Litorale è disponibile anche nella versione da appoggio in combinazione con i contenitori del sistema Evo21 recentemente introdotto a catalogo.

Nella versione in appoggio su contenitori, il catino deve coprire l'intera lunghezza della composizione. L'altezza del lavabo è di soli 6 cm e la gamma delle lunghezze riprende quelle della versione autoportante a parete (da 80 a 240 cm) come pure la possibilità di inserire dei piani di appoggio di diverse dimensioni (20, 40 e 60 cm) in due diversi materiali (solid surface bianco o legno iroko massello). Per ulteriori approfondimenti rimandiamo alla sezione dedicata ad Evo21 del catalogo Agape Systems.

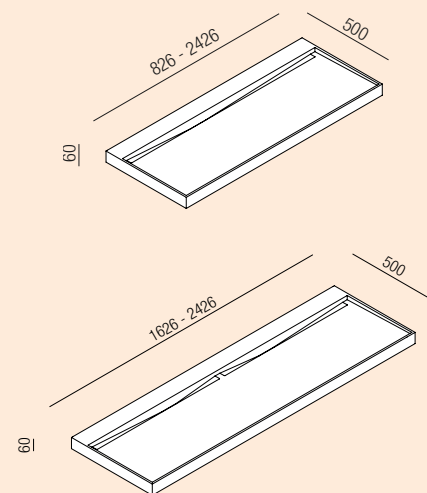

design Benedini Associati, 2021

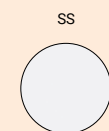

Litorale

Over countertop washbasin on Evo 21 / Lavabo in appoggio su Evo 21

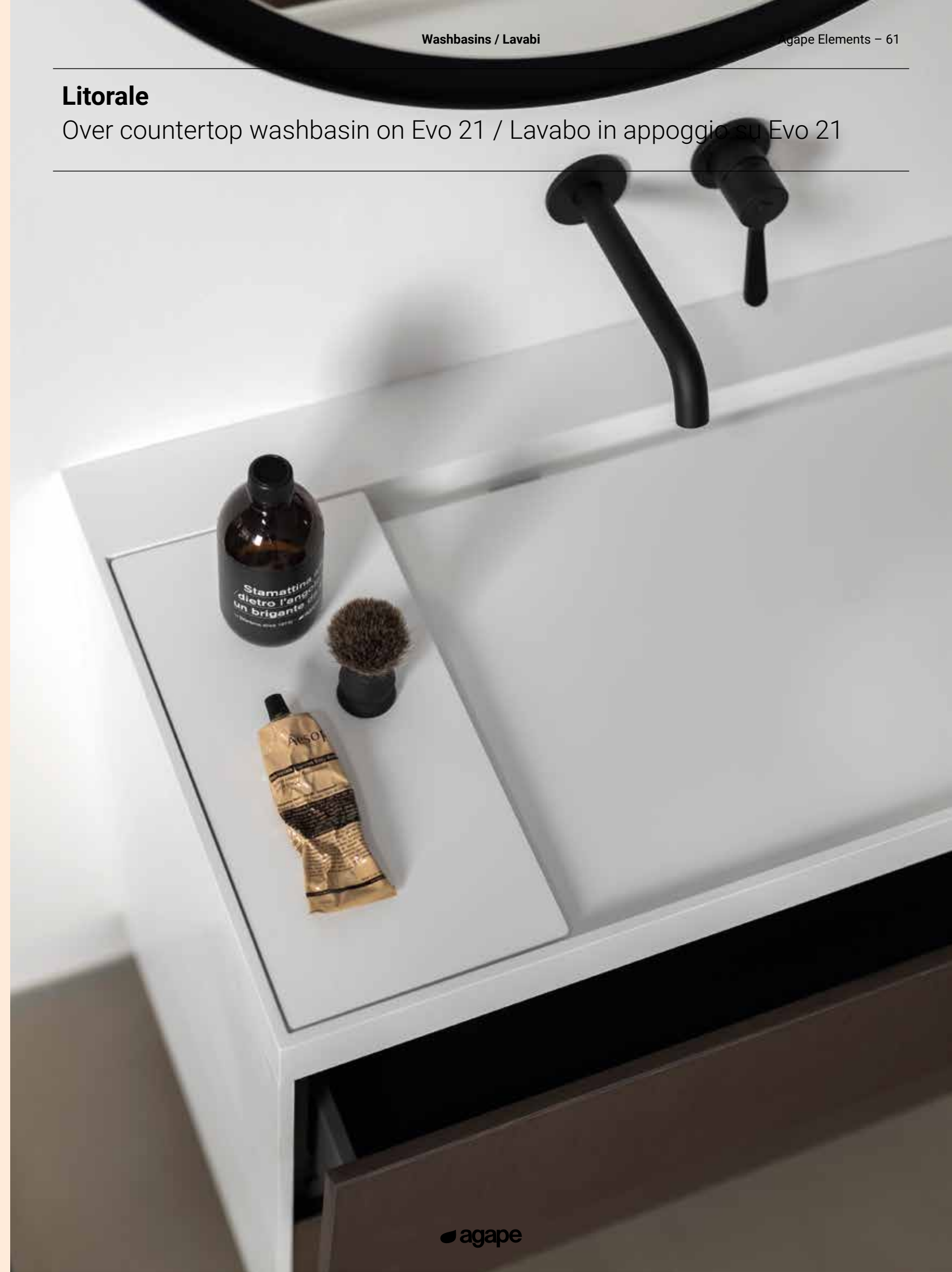

Marsiglia

Wall mounted and over countertop washbasin / Lavabo a parete e da appoggio

The Marsiglia washbasin, made of Cristalplant® biobased, reminds the precise but never squared features of the tub of the same name, inspired by the ancient sinks. The washbasin incorporates a comfortable and functional internal shelf which, in addition to acting as a support surface, can also house the taps and fittings. Available in matt white or two-tone with dark grey or light grey exterior. Available in the wall mounted or over countertop version.

Il lavabo Marsiglia, realizzato in Cristalplant® biobased, riprende i tratti precisi ma mai squadrati dell'omonima vasca, ispirata agli antichi lavatoi. Il lavabo incorpora un comodo e funzionale ripiano interno che, oltre a fungere da superficie d'appoggio, può ospitare anche la rubinetteria. Disponibile in bianco opaco o bicolore con esterno grigio scuro o grigio chiaro. Disponibile nella versione a parete o da appoggio.

ACER0705M0R
ACER0705M1R
ACER0705M3R

ACER0705P0R
ACER0705P1R
ACER0705P3R

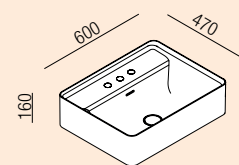

design LucidiPevere, 2018



Neb

Over countertop washbasin / Lavabo da appoggio

The Neb over countertop washbasin echoes the concept of the formal lightness of the bathtub of the same name. It combines a slimline profile with an extra-deep basin thanks to the use of a technologically advanced material: Cristalplant® biobased, featured in a matt white or two-colour finish with a dark or light grey exterior.

Il lavabo da appoggio Neb riprende il concetto di leggerezza formale dell'omonima vasca, unendo uno spessore sottile ad una capiente profondità, grazie all'utilizzo di un materiale tecnologicamente evoluto: il Cristalplant® biobased, in versione bianca o bicolore con esterno grigio scuro o grigio chiaro.

ACER0701

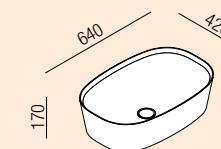

design Benedini Associati, 2018



Nivis

Column washbasin / Lavabo a colonna

The Nivis washbasin consists of two interconnected cavities, with water running from the main, larger and deeper cavity to the smaller one which has an overflow outlet hole. A sculptural design that creates a dynamic and harmonious effect on the solid white mass of Cristalplant® biobased or of white Carrara, grey Carnic, black Marquina, green Alpi or of Emperador dark marble.

Il lavabo Nivis è composto da due concavità collegate, con l'acqua che scorre da quella principale, più ampia e profonda, a quella minore, con foro per il troppo pieno. Un artificio scultoreo che crea un effetto dinamico e armonioso sulla bianca massa del Cristalplant® biobased o del marmo bianco di Carrara, del grigio Carnico, del nero Marquina, del verde Alpi o dell'Emperador dark.

ACER0763FM0_
ACER0763FP0_

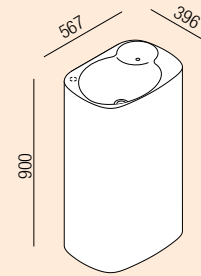

Selected "ADI DESIGN INDEX" 2012
Honorable Mention "XXII COMPASSO D'ORO"

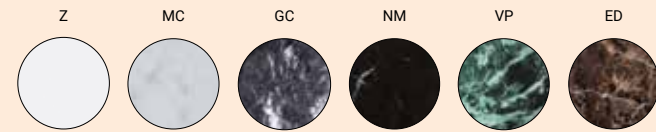

design Andrea Morgante (Shiro Studio), 2010



Nivis

Wall mounted washbasin / Lavabo a parete

The Nivis washbasin is composed of two connected concavities, with the water flowing from the main one, wider and deeper, to the smaller one, with an overflow hole. A sculptural artifice that creates a dynamic and harmonious effect on the white mass of Cristalplant® biobased.

Il lavabo Nivis è composto da due concavità collegate, con l'acqua che scorre da quella principale, più ampia e profonda, a quella minore, con foro per il troppo pieno. Un artificio scultoreo che crea un effetto dinamico e armonioso sulla bianca massa del Cristalplant® biobased.

ACER0763MRZ
ACER0763M0Z

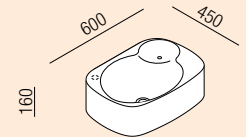

Selected "ADI DESIGN INDEX" 2012
Honorable Mention "XXII COMPASSO D'ORO"

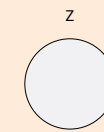

design Andrea Morgante (Shiro Studio), 2010



Nivis

Over countertop washbasin / Lavabo da appoggio

Nivis, from the Latin Nix/snow: symbol for excellence of purity and sinuosity, the same sensations that arise when observing this elegant washbasin and touching its material - Cristalplant® biobased - just as silky and white. The two internal concavities allow the elegant flow of water from large to small which acts as an overflow. Nivis is also available in white Carrara marble, grey Carnic, black Marquina, green Alpi or Emperador dark marble.

Nivis, dal latino Nix/neve: simbolo per eccellenza di purezza e di sinuosità, le medesime sensazioni che scaturiscono osservando questo elegante lavabo e toccandone il materiale - Cristalplant® biobased - altrettanto setoso e bianco. Le due concavità interne permettono lo scorrere elegante dell'acqua dalla grande alla piccola che funge da troppo pieno. Nivis è disponibile anche in marmo bianco di Carrara, grigio Carnico, nero Marquina, verde Alpi o in Emperador dark.

ACER0763PR_
ACER0763PO_

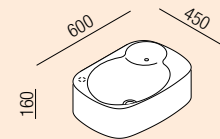

Selected "ADI DESIGN INDEX" 2012
Honorable Mention "XXII COMPASSO D'ORO"

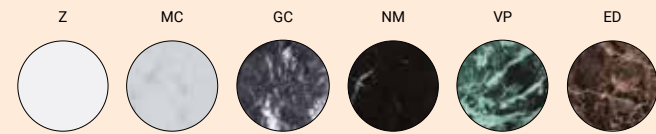

design Andrea Morgante (Shiro Studio), 2010



Normal

Over countertop washbasin / Lavabo da appoggio

A large and inviting basin, surrounded by a slim edge. A pure and simple shape for a bathroom based on a sophisticated and natural simplicity. In white Cristalplant® biobased, the Normal basin is suitable for endless compositions and coordinations, resting on the tops from the Flat XL, Evoluzione and Lato ranges.

Un ampio e accogliente bacino, circondato da un bordo sottile. Una forma pura e semplice, per un bagno improntato ad una raffinata e naturale semplicità. Realizzato in Cristalplant® biobased bianco, il lavabo Normal si presta a infinite composizioni e abbinamenti, in appoggio sui piani dei programmi Flat XL, Evoluzione e Lato.

ACER0797Z

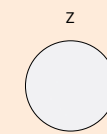
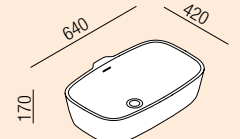

design Benedini Associati, 2008



Novecento XL

Wall mounted washbasin / Lavabo a parete

Novecento XL interprets in a modern way the forms of the past, transferring them in a new, important and inviting atmosphere. On both sides of this washbasin with sinuous shape, two large storage surfaces. Introduced in white Ceramilux®, polished or matt or two-coloured white and light or dark grey. Available in two versions: wall mounted or supported by a structure in polished stainless steel or brushed burnished brass or painted white, dark grey or light grey.

Novecento XL interpreta in chiave moderna le linee del passato, trasportandole in una dimensione nuova, importante e accogliente. Ai lati di questo lavabo dalle forme sinuose, sono presenti due ampie superfici di appoggio. È proposto in Ceramilux® bianco, lucido o opaco, oppure bicolore nelle varianti bianco e grigio chiaro o bianco e grigio scuro. Disponibile in versione da parete, oppure con struttura in acciaio inox o laccato in bianco, grigio chiaro, grigio scuro o brunito spazzolato.

ACER10700R_
ACER10701R_
ACER10703R_
ACER1072_

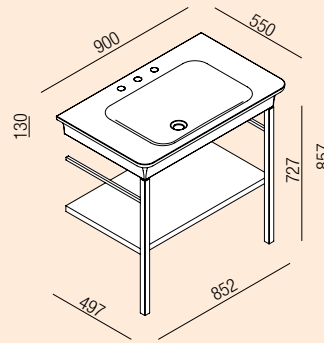

Washbasin finish / Finitura lavabo

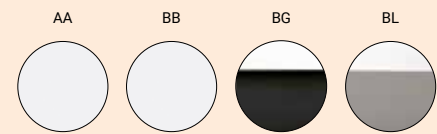

Structure finish / Finitura struttura

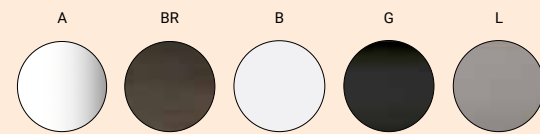

design Benedini Associati, 2014



Novecento XL

Wall mounted washbasin / Lavabo a parete

Novecento XL – washbasin / lavabo
Memory – taps / rubinetteria
Memory – mirror / specchio
Memory – accessories / accessori



Ottocento

Wall mounted washbasin / Lavabo a parete

Romantic and elegant, the Ottocento washbasin revisits the shapes of a remote past, like the bathtub of the same name, for installation with modern versatility in any space and context. Made in Cristalplant® biobased, it is available in white and in two dual colour versions: white and dark grey, or white and light grey; with or without tap holes is positioned on a stainless steel structure, available in white, light grey, dark grey or brushed burnished.

Romantico ed elegante, il lavabo Ottocento riprende le forme di un remoto passato, come l'omonima vasca, inserendosi con moderna versatilità in ogni spazio e contesto. Realizzato in Cristalplant® biobased, è proposto in versione bianca e in due varianti bicolori: bianco e grigio scuro, oppure bianco e grigio chiaro. Disponibile in versione da parete, oppure con struttura in acciaio inox naturale o laccato in bianco, grigio chiaro, grigio scuro o brunito spazzolato.

ACER07660R_
ACER07661R_
ACER07663R_

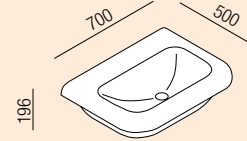

ACER0767_
ACER0766_

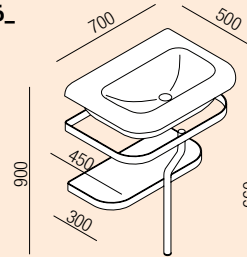

Washbasin finish / Finitura lavabo

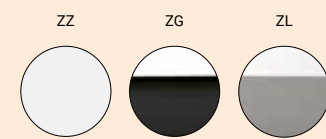

Structure finish / Finitura struttura

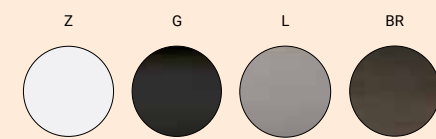

design Benedini Associati, 2009



Ottocento

Wall mounted washbasin / Lavabo a parete



Ottocento – washbasin / lavabo
Memory – taps / rubinetteria
Memory – mirror / specchio
Memory – accessories / accessori

Ottocento 001, Ottocento 002

Built-in and integrated washbasins / Lavabi ad incasso e integrati

These two versions of the washbasin, seamlessly integrate the delicate curves and ample basins (60 and 80 cm) of Ottocento in the 3, 6 or 12 cm thick Flat XL countertops in Cristalplant® biobased or in white Carrara, black Marquina, green Alpi and Emperador dark marble. According to the length of the top, it is possible to specify double basin configurations for both versions. Ottocento 001 in Cristalplant® biobased is also available to be built-in in countertops in different finishes supplied by the client (art. ACER0899Z).

Queste due versioni del lavabo integrano le curve delicate degli ampi catini Ottocento (da 60 e 80 cm) nei piani da 3, 6 o 12 cm del programma Flat XL in Cristalplant® biobased o in marmo bianco di Carrara, nero Marquina, verde Alpi o Emperador dark. In base alla lunghezza dei piani è possibile avere la configurazione a doppio lavabo per entrambe le versioni. Ottocento 001 nella versione in Cristalplant® biobased è disponibile anche per essere incassato in piani di finiture diverse a cura del cliente (art. ACER0899Z).

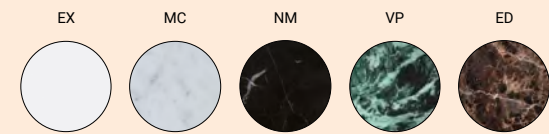
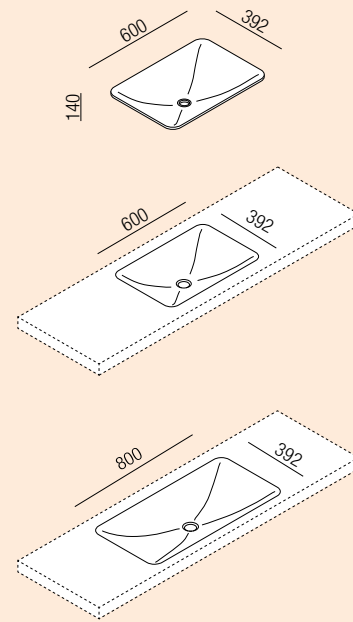

design Benedini Associati, 2002



Ottocento 001, Ottocento 002

Built-in and integrated washbasins / Lavabi ad incasso e integrati



Ottocento 001 – integrated washbasin / lavabo integrato
 Flat XL – countertop / piano
 Flat XL – storage units / contenitori
 Memory – taps / rubinetteria
 Memory – mirror / specchio
 Memory – accessories / accessori

Ottocento 001

Built-in and integrated washbasin / Lavabo ad incasso e integrato

Built-in / Ad incasso

ACER0899Z

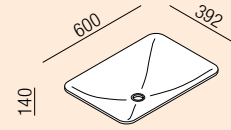

Integrated into the Flat XL top / Integrato nel piano Flat XL

Top finishes /
Finiture del pianoCountertops to be rested on cabinets /
Piani da appoggioSelf-bearing countertops /
Piani autoportanti

Flat XL Ottocento 001

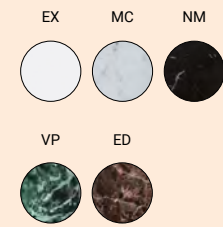
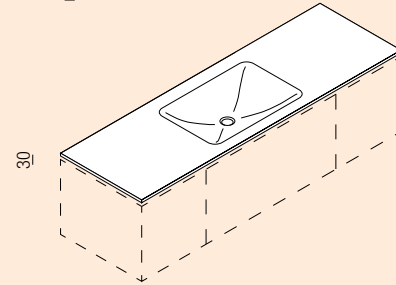
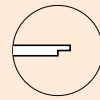
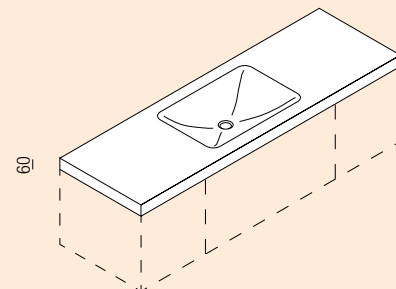
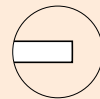
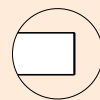
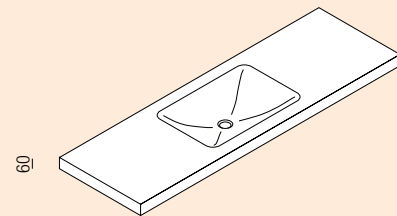
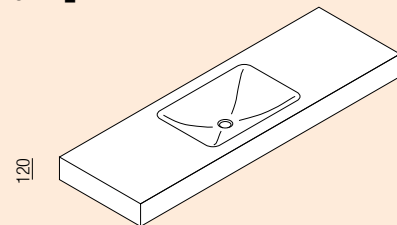
3 cm
Countertop / PianoAXXM011Z_
AXXM012Z_6 cm
Countertop / PianoAXMM011Z_
AXMM012Z_12 cm
Countertop / PianoAXNM011Z_
AXNM012Z_AXAM011Z_
AXAM012Z_**Ottocento 002**

Integrated washbasin / Lavabo integrato

Integrated into the Flat XL top / Integrato nel piano Flat XL

Top finishes /
Finiture del pianoCountertops to be rested on cabinets /
Piani da appoggioSelf-bearing countertops /
Piani autoportanti

Flat XL Ottocento 002

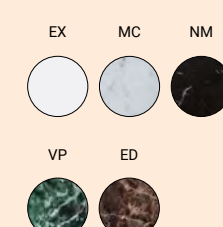
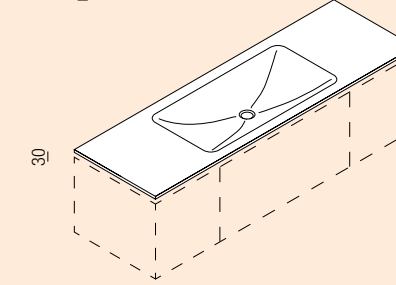
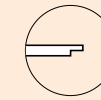
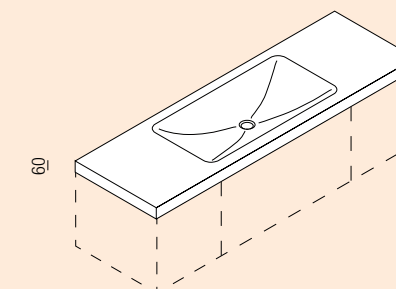
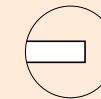
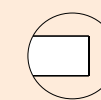
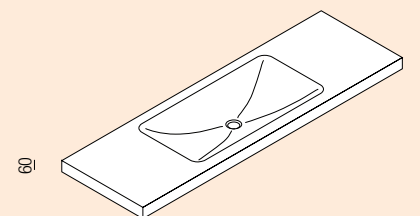
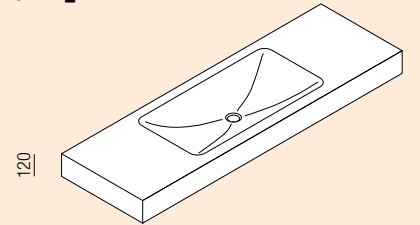
3 cm
Countertop / PianoAXXM021Z_
AXXM022Z_6 cm
Countertop / PianoAXMM021Z_
AXMM022Z_12 cm
Countertop / PianoAXNM021Z_
AXNM022Z_AXAM021Z_
AXAM022Z_

Pear

Wall mounted washbasin / Lavabo a parete

Soft yet clean lines, inspired by nature, for this washbasin Pear, available in glossy or matt white ceramic or two-colour. The two-colour version, white inside and dark grey outside, gives the bathroom an almost "optical" look. The ceramic washbasin completes the sanitary ware range.

Linee morbide e pulite, ispirate dalla natura, per il lavabo Pear, disponibile in ceramica bianca lucida o opaca o bicolore. La variante bicolore, bianca all'interno e grigio scuro all'esterno, caratterizza lo spazio bagno con un effetto quasi "optical". Il lavabo in ceramica completa la serie dei sanitari.

ACER08950R_
ACER08951R_
ACER08953R_

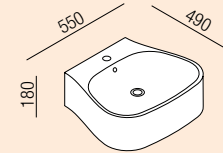

Selected "ADI DESIGN INDEX" 2005

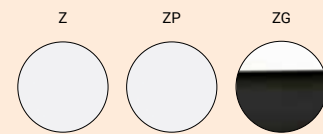

design Patricia Urquiola, 2004



Pear C

Column washbasin / Lavabo a colonna

Made in white Cristalplant® biobased or in white Carrara, grey Carnic, black Marquina, green Alpi or Emperador dark marble, it echoes the unmistakable style of sanitary collection of the same name, dominating the space with its soft and strong volume, carved like a monolith. Available with floor or wall drain version.

Realizzato in Cristalplant® biobased bianco o nei marmi bianco di Carrara, grigio Carnico, nero Marquina, verde Alpi o Emperador dark, riprende l'inconfondibile stile dei sanitari dell'omonima collezione, imponendosi nello spazio con il suo volume morbido e deciso, scolpito come un monolite. Disponibile con versione per scarico a pavimento o a muro.

ACER0896M_
ACER0896F_

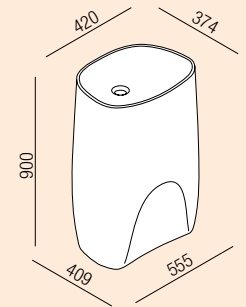

Winner "NEW CLASSIC" 2009
Selected "EDIDA" 2008

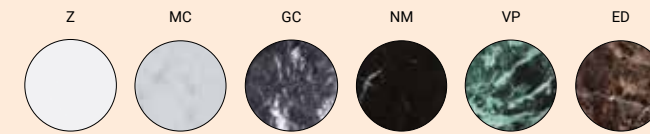

design Patricia Urquiola, 2007



Petra

Column and wall mounted washbasin / Lavabo a colonna e a parete

Petra is made of Cementoskin®, a cement resistant to any type of dirt and with unique aesthetic characteristics. The surface finish is natural and velvety, and inspires the entire collection, suitable both for outdoor use, from large gardens to small terraces, and for the more usual indoor situations. The wall version can be fixed directly to the wall or on a column that supports the washbasin, in turn fixed to the wall and available in three different heights.

Petra è realizzato in Cementoskin®, cemento resistente a qualsiasi tipo di sporco e con caratteristiche estetiche uniche. La finitura superficiale risulta naturale e vellutata, e ispira l'intera collezione adatta sia all'ambito esterno, dai grandi giardini ai piccoli terrazzi, sia alle più consuete situazioni indoor. La versione a parete può essere fissata direttamente a muro o su colonna che supporta il lavabo, a sua volta fissata a parete e disponibile in tre diverse altezze.

☀️ ACER092_

☀️ ACER094_ H 1400

☀️ ACER095_ H 1250

☀️ ACER096_ H 895

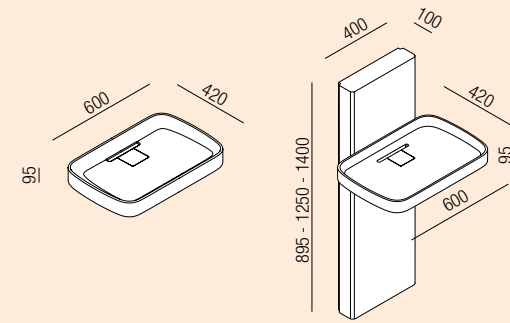

Winner "STYLEPARK SELECTED AWARD" 2020

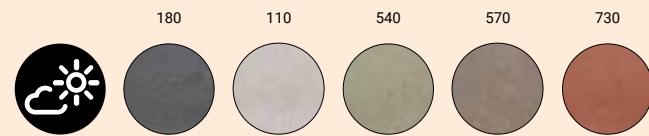

design Diego Vencato, Marco Merendi, 2018



Petra

Family / Famiglia

The Petra family includes sink, tray and platform for shower and hose reel, all made of Cementoskin® with a natural and velvety surface available in different colors. The shower tray follows the shape of the washbasin of the same name, while the platform is made up of slats gathered by a stainless steel perimeter profile complete with anchors for fixing to the ground. The use of the column in combination with the washbasin or the shower tray offers various aesthetic advantages, such as the coverage of the connections, and functional, thanks to the wall taps that can be positioned directly on the column thus avoiding the need for holes and risks of breakage.

La famiglia Petra comprende lavabo, piatto e pedana per doccia ed avvolgitubo, tutti realizzati in Cementoskin® con superficie naturale e vellutata disponibile in diverse colorazioni. Il piatto doccia ricalca la sagoma del lavabo omonimo, mentre la pedana è composta da doghe raccolte da un profilo perimetrale in acciaio inox completo di ancoraggi per il fissaggio al suolo. L'utilizzo della colonna in abbinamento al lavabo o al piatto doccia offre diversi vantaggi sia estetici, come la copertura degli attacchi, che funzionali, grazie alla rubinetteria a parete che può essere posizionata direttamente sulla colonna evitando così la necessità di fori e rischi di rotture.

Discover the Petra collection showers at page 190 / Scopri le docce della collezione Petra a pagina 190

Petra family / Famiglia Petra

Washbasin /
Lavabo

Slatted shower
tray / Pedana per
doccia

Hose reel /
Avvolgitubo

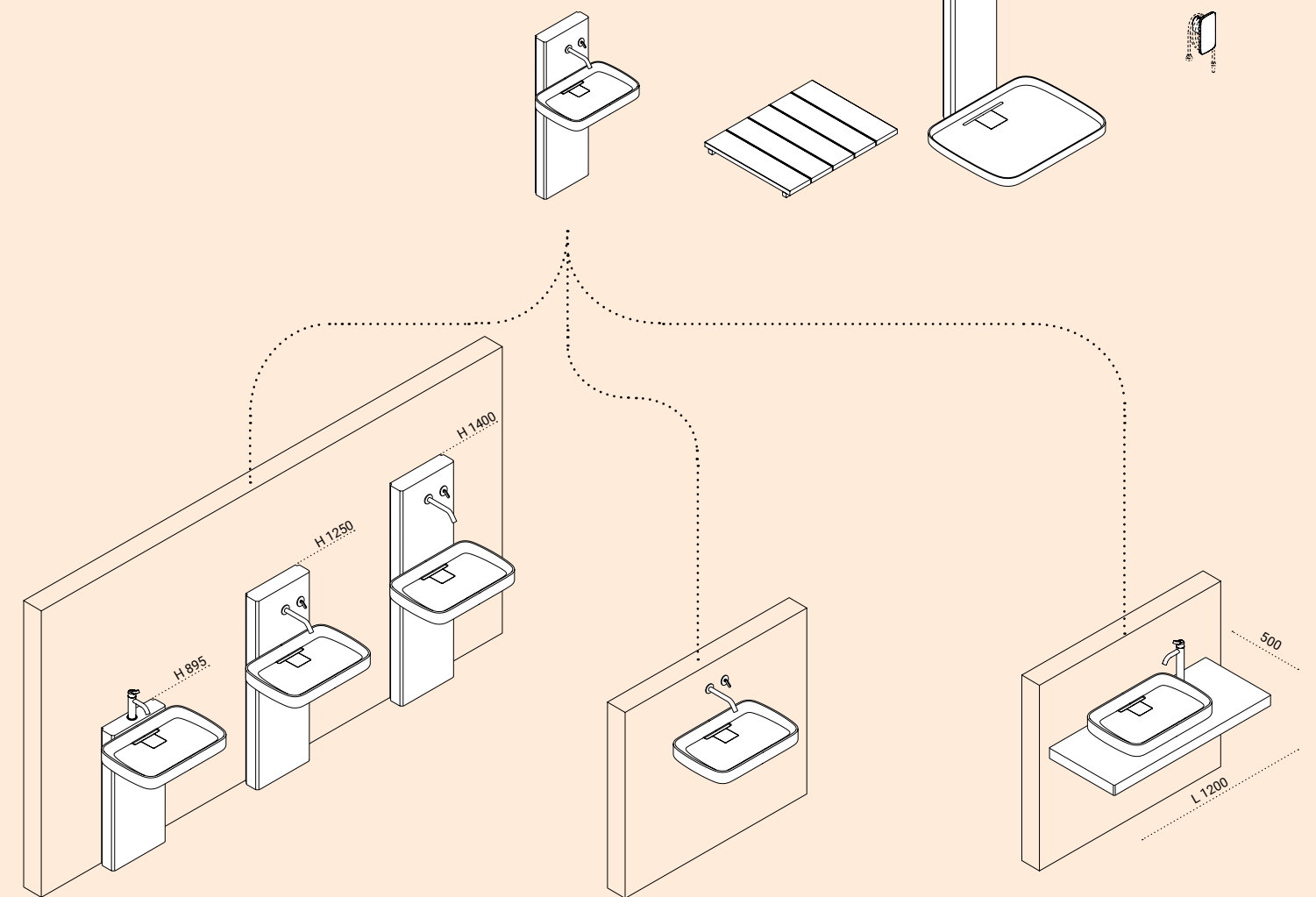

Column mounting / Montaggio su colonna

Direct wall mounting / Montaggio diretto alla parete

Resting on the top / Montaggio su piano

Petra

Over countertop washbasin / Lavabo da appoggio

The countertop version further enhances the functionality of the Petra washbasin: in addition to the new material - Cementoskin®, particularly resistant to dirt and with unique aesthetic characteristics - the countertop increases its practicality. Possibility of use both indoors and outdoors of various sizes, from large gardens to more intimate balconies.

La versione su piano esalta ancora di più la funzionalità del lavabo Petra: oltre al materiale inedito - Cementoskin®, particolarmente resistente allo sporco e con caratteristiche estetiche uniche - il piano di appoggio aumenta la sua praticità. Possibilità di utilizzo sia indoor che in ambienti esterni di varie dimensioni, dagli ampi giardini ai balconi più intimi.

☀️ ACER092_

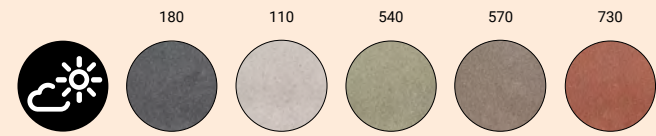
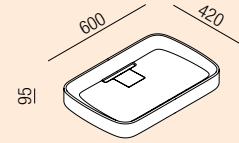

design Diego Vencato, Marco Merendi, 2018



Petra

Over countertop washbasin / Lavabo da appoggio

Petra – washbasin / lavabo
 Petra – countertop / piani
 Sen – taps / rubinetteria
 Memory – mirror / specchio



Raso

Over countertop washbasin / Lavabo da appoggio

Almost twenty years from the release of its first version, the Raso washbasin debuts in the newfangled over-countertop version for every Agape container system. The new washbasin evolves its lines, details and dimensions while remaining faithful to the clean geometries that made the original version so iconic and versatile at the same time. Raso over-countertop is available in one size in thermoformed acrylic solid surface or in marble, in the following finishes: white Carrara, gray Carnic, black Marquina, green Alpi, Emperador dark and Petit Granit.

A quasi vent'anni dal lancio della prima versione, il lavabo Raso debutta nell'inedita versione da appoggio da collocare sui piani dei diversi programmi Agape. Il nuovo lavabo si raffina nelle sue linee e si aggiorna nei dettagli e nelle dimensioni in sintonia con il rigore geometrico che lo ha reso allo stesso tempo iconico e molto versatile nei suoi abbinamenti. La versione in appoggio è disponibile in una sola dimensione nelle versioni in solid surface termoformato a base acrilica oppure in marmo, in tutte le finiture Agape a catalogo: bianco di Carrara, grigio Carnico, nero Marquina, verde Alpi, Emperador dark e Petit Granit.

ACER0385_

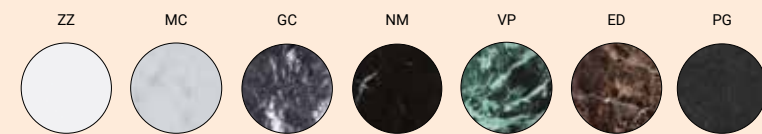
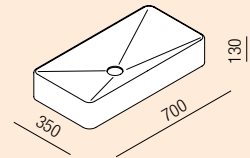

design Benedini Associati, 2021



Raso

Over countertop washbasin / Lavabo da appoggio

Raso – washbasin / lavabo
Evo 21 – programme / programma
Memory Mix – taps / rubinetteria
Eclissi – mirror / specchio



Raso

Evo 21 Integrated washbasin / Lavabo integrato nel piano Evo 21

Together with the release of the new Evo 21 system, the Raso integrated washbasin, a long-seller in the Agape catalogue, also gets updated in its dimensions, details and materials. The new version remains faithful to the iconic geometries of Giampaolo Benedini's original design from 2003 and can be integrated in the new 12 mm Evo 21 solid surface countertops also in configurations with double basin.

In occasione del lancio del sistema Evo 21, il lavabo Raso integrato, long seller del catalogo Agape, si aggiorna nei materiali, nei dettagli e nelle dimensioni. La nuova versione rimane fedele al rigore iconico del progetto originale di Giampaolo Benedini del 2003 e può essere inserito sui piani Evo 21 in solid surface da 12 mm anche in configurazione con doppio lavabo.

AE21PA185I_SS
AE21PA285I_SS

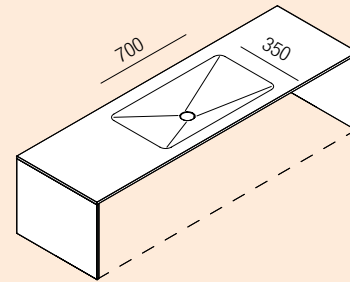

SS (Evo 21)

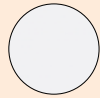

design Benedini Associati, 2021



Raso

Evo 21 Integrated washbasin / Lavabo integrato nel piano Evo 21

Raso – integrated washbasin / lavabo integrato nel piano
Evo 21 – programme / programma
Memory Mix – taps / rubinetteria

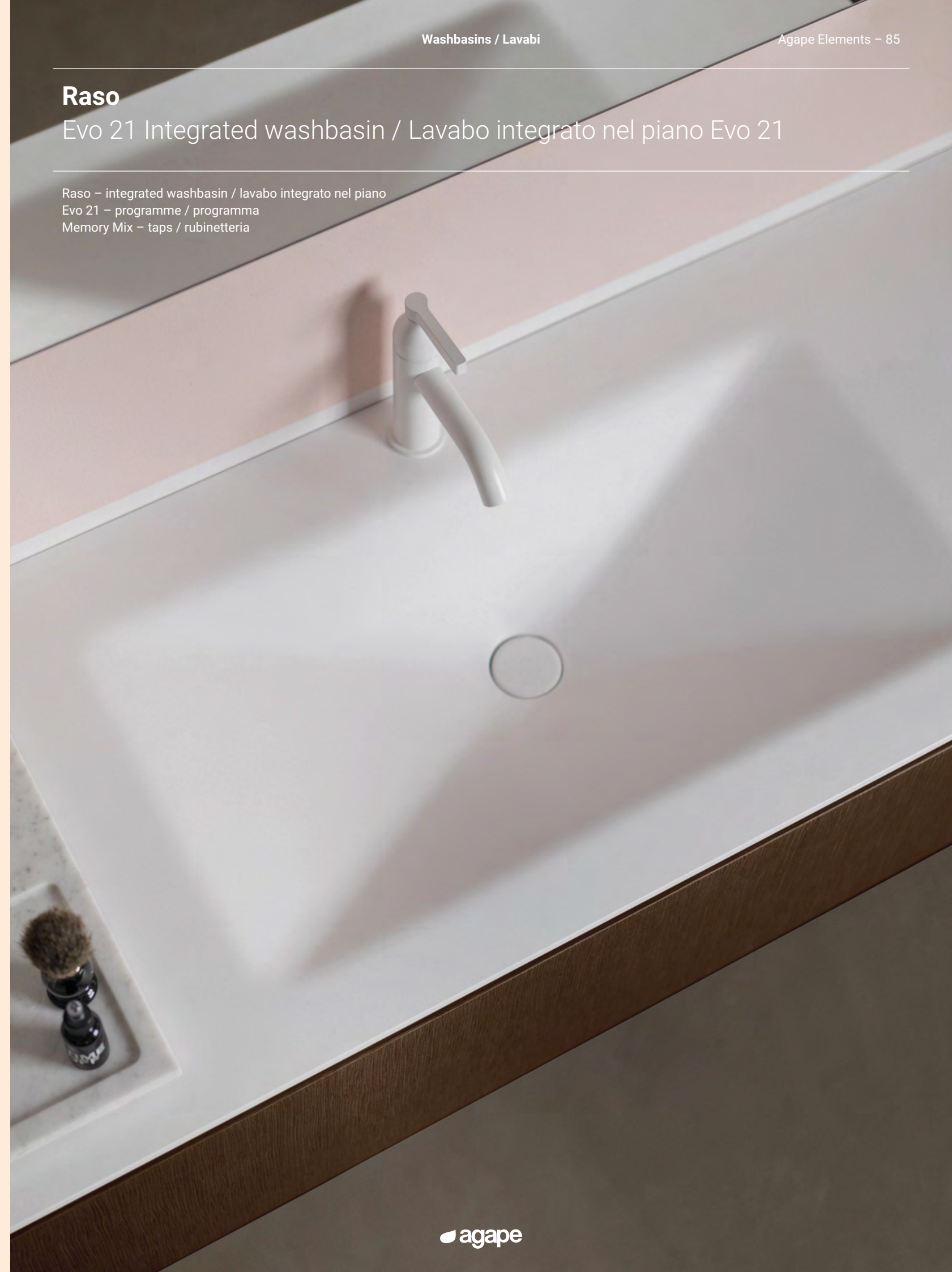

Spoon, Spoon XL

Over countertop washbasins / Lavabi da appoggio

Made of white Cristalplant® biobased, the Spoon and Spoon XL washbasins can give life to multiple compositional possibilities: for example in the countertop version on a Flat XL oak top. The enlarged shapes of Spoon XL maintain its essential and enveloping elegance unaltered.

Realizzati in Cristalplant® biobased bianco, i lavabi Spoon e Spoon XL possono dare vita a molteplici possibilità compositive: ad esempio nella versione da appoggio su un piano Flat XL in rovere. Le forme allargate di Spoon XL mantengono inalterata la sua essenziale e avvolgente eleganza.

ACER0700Z

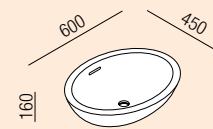

ACER0713Z

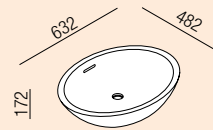

design Benedini Associati, 2002 / 2005

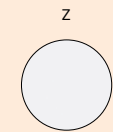

Spoon, Spoon XL

Semi-recessed washbasins / Lavabi a semincasso

Semi-recessed oval washbasins made of white Cristalplant® biobased. Spoon and Spoon XL, with their essential and enveloping elegance, fit perfectly into tops of different thicknesses.

Lavabi a semincasso ovali realizzati in Cristalplant® biobased bianco. Spoon e Spoon XL, con la loro essenziale ed avvolgente eleganza, si inseriscono perfettamente nei piani di diversi spessori.

ACER0700IZ

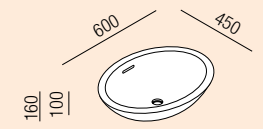

ACER0713IZ

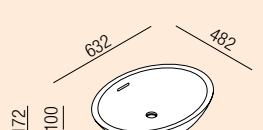

design Benedini Associati, 2002 / 2005

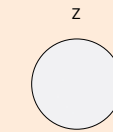

Undici

Over countertop washbasins / Lavabi da appoggio

Undici washbasins, the name, italian for “eleven” comes from the characteristic that remains unchanged in the different versions: the height of 11 cm.

Made of white solid surface with thermoforming processing, they are available in three shapes: round, oval or rectangular; they can be placed on all Agape tops or under the Evo 21 tops of the same material, becoming integrated elements on the top itself.

Lavabi Undici, il nome nasce dalla caratteristica che resta invariata nelle diverse versioni: l'altezza di cm 11.

Realizzati in solid surface bianco con lavorazione in termoformatura, sono disponibili in tre forme: tondo, ovale o rettangolare; possono essere posizionati in appoggio su tutti i piani Agape o incassati nei piani Evo 21 del medesimo materiale diventando elementi integrati al piano stesso.

ACER0381

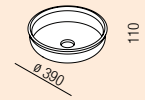

ACER0384

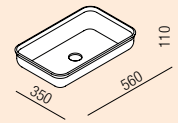

ACER0386

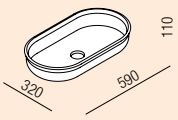

design Benedini Associati, 2021

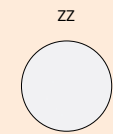

Undici

Over countertop washbasins / Lavabi da appoggio

Undici – washbasin / lavabo
Evo 21 – programme / programma
Memory Mix – taps / rubinetteria
Seppia – mirror / specchio



Undici Inox

Over countertop washbasin / Lavabo da appoggio

The Undici Inox washbasin comes from the Undici family of the same name, it is made of AISI 304 steel (in brass for the brushed burnished and brushed natural brass finishes) by turning from 3 mm slabs. Its pure shape allows to maintain the same geometry for the countertop and recessed version (the recessed version is available only for Evo 21 marble tops of 20 mm). Three finishes available: brushed stainless steel, brushed natural brass and brushed burnished.

Il lavabo Undici Inox nasce dall'omonima famiglia Undici, viene realizzato in acciaio AISI 304 (in ottone per le finiture brunito spazzolato e ottone naturale spazzolato) per tornitura da lastre di mm 3.

La sua forma pura consente di mantenere la stessa geometria per la versione da appoggio e ad incasso (la versione ad incasso è disponibile solo per piani Evo 21 in marmo da 20 mm). Tre le finiture disponibili: inox spazzolato, ottone naturale spazzolato e brunito spazzolato.

ACER0380

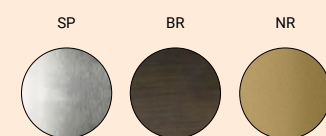
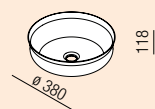

design Benedini Associati, 2021



Undici Inox

Over countertop washbasin / Lavabo da appoggio

Undici inox – washbasin / lavabo
Evo 21 – programme / programma
Memory Mix – taps / rubinetteria
Bucatini – mirror / specchio



Undici, Undici Inox

Evo 21 integrated washbasins / Lavabi integrati nel piano Evo 21

AE21PA181I_SS
AE21PA281I_SS

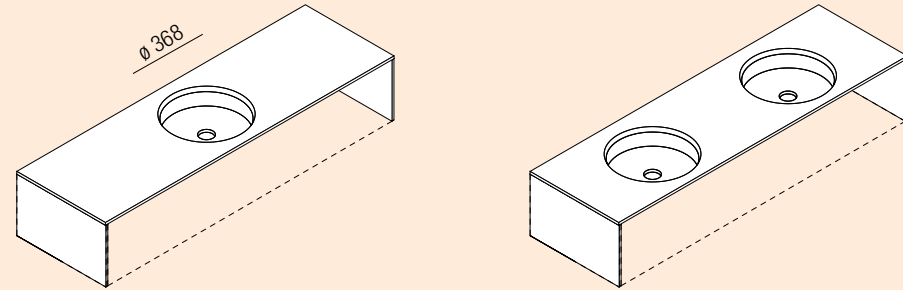

AE21PA184I_SS
AE21PA284I_SS

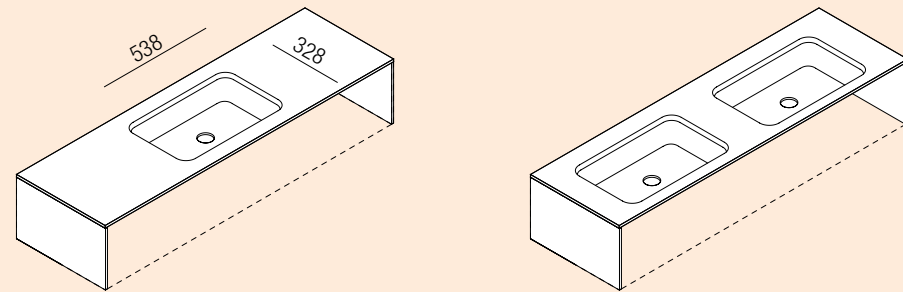

AE21PA186I_SS
AE21PA286I_SS

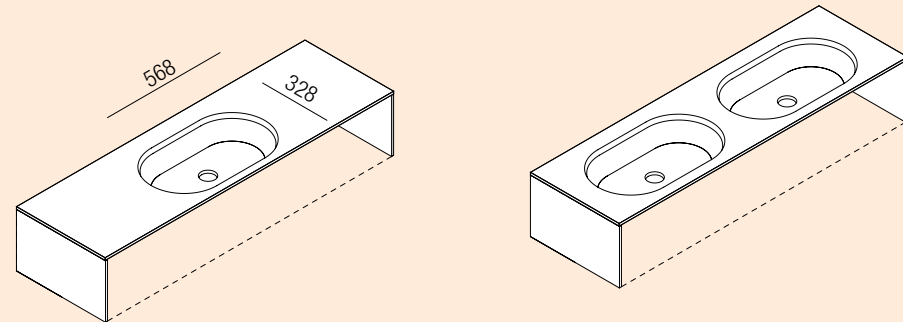

AE21PD1_
AE21PD2_

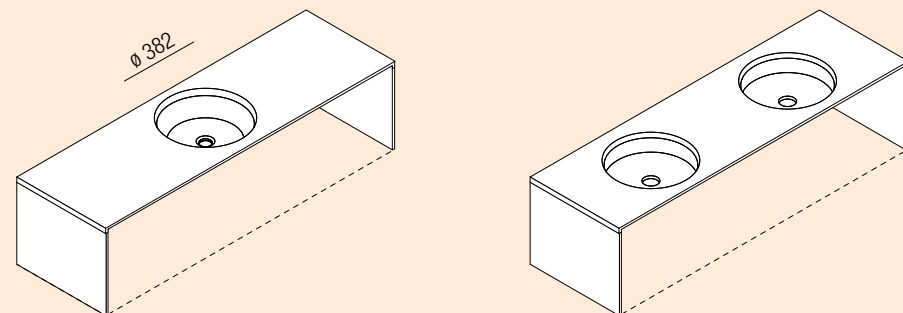

Undici, Undici Inox

Evo 21 integrated washbasins / Lavabi integrati nel piano Evo 21



Vieques

Column washbasin / Lavabo a colonna

The Vieques washbasins echo the style of the bathtub of the same name, a refined interpretation of bygone days conjuring up a stand-out element. The column freestanding version can also be placed in open spaces in direct exposure to atmospheric agents. Made of stainless steel and proposed in a completely white or two-tone version with dark grey or light grey exterior.

The washbasin has the possibility of applying a rectangular shelf in iroko wood to the edge, in order to offer a useful support surface. Available with floor or wall drain version.

I lavabi Vieques riprendono la matrice stilistica della vasca con il medesimo nome, raffinata interpretazione di archetipi della memoria, per dare vita a un elemento dalla forte personalità. La versione freestanding, dalla forma a colonna, può essere collocata anche in spazi aperti in esposizione diretta agli agenti atmosferici. Realizzata in acciaio inox e proposta con verniciatura completamente bianca oppure bicolore con esterno grigio scuro o grigio chiaro. Il lavabo ha la possibilità di applicare sul bordo una mensola rettangolare in legno di iroko, in modo da offrire un'utile superficie di appoggio. Disponibile con versione per scarico a pavimento o a muro.

ACERO798M_
ACERO798F_
ACERO798EM_
ACERO798EF_

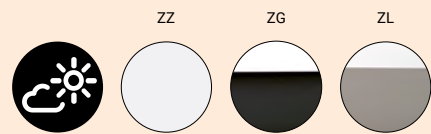
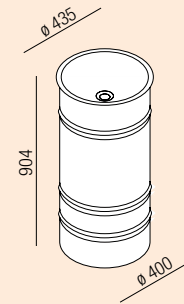

design Patricia Urquiola, 2007 / 2018



Vieques

Over countertop washbasin / Lavabo da appoggio

Countertop washbasin, with a height of 19 cm, always with the characteristic design of the Vieques family. Two washbasins placed on top that can also be used in open spaces in direct exposure to atmospheric agents. Made of white painted stainless steel (RAL9003) or two-tone with dark grey (RAL7021) or light grey (RAL7044) exterior.

Lavabo da appoggio tondo, sempre con il caratteristico design della famiglia Vieques. Due lavabi collocati su piano che possono essere utilizzati anche in spazi aperti in esposizione diretta agli agenti atmosferici. Realizzati in acciaio inox verniciato bianco (RAL9003) o bicolore con esterno grigio scuro (RAL7021) o grigio chiaro RAL7044).

ACERO798P_
ACERO798EP_

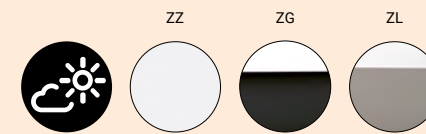
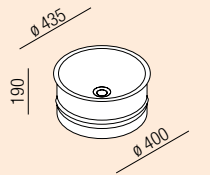

design Patricia Urquiola, 2011 / 2018



Countertops / Piani per lavabi

A wide programme of countertops available in different heights, dimensions and materials that integrate with Agape washbasins for furnishing and personalizing the bathroom. A system that allows each individual to find an ideal solution.

Un vasto programma di piani di vari spessori, lunghezze e materiali che si integrano con i lavabi Agape per arredare e personalizzare il bagno permettendo a ciascuno di trovare la soluzione ideale.



Flat XL

Countertop / Piano per lavabo

The countertops are the heart of every Flat XL composition, the starting point for every project. The choice of the top, together with the washbasin, its position, its length, its thickness and finish will determine the other elements of the composition itself. Every countertop is 50 cm deep.

I piani sono il cuore di una composizione Flat XL, il punto di partenza del progetto. Insieme alla scelta del lavabo, la posizione del piano, la sua lunghezza, il suo spessore e finitura determineranno successivamente gli altri elementi della composizione. Tutti i piani hanno profondità cm 50.

design Benedini Associati, 2002

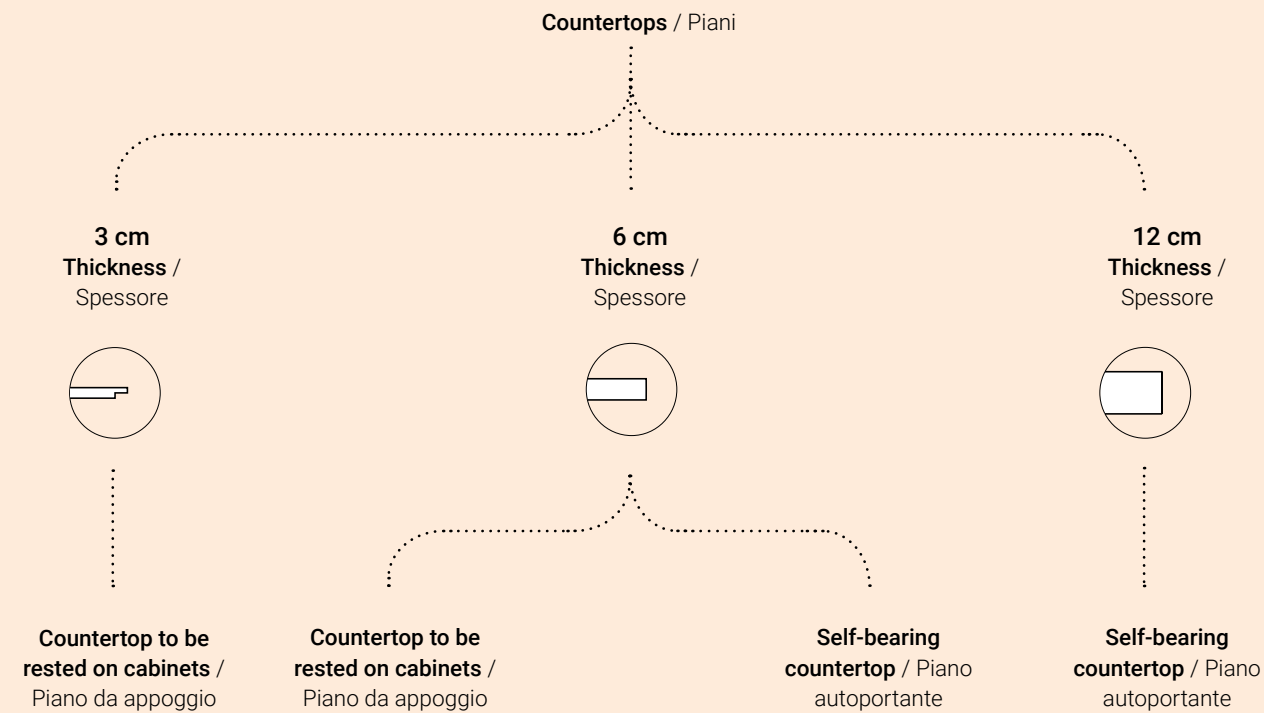

Flat XL

Countertop / Piano per lavabo

Top finishes / Finiture piano

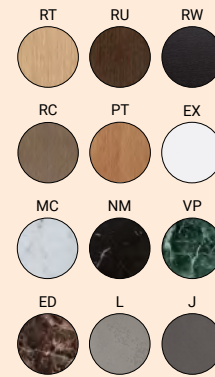

Countertops to be rested on cabinets / Piani da appoggio

3 cm
Countertop / Piano

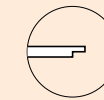

AXX_

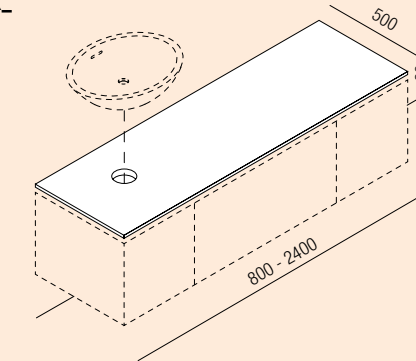

6 cm
Countertop / Piano

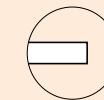

AXM_

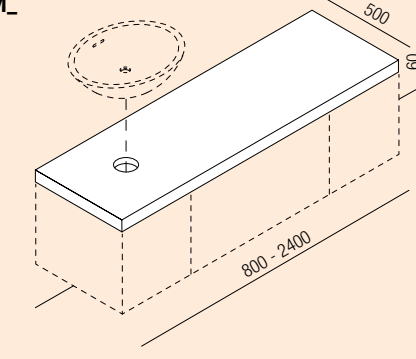

12 cm
Countertop / Piano

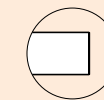

AXA_

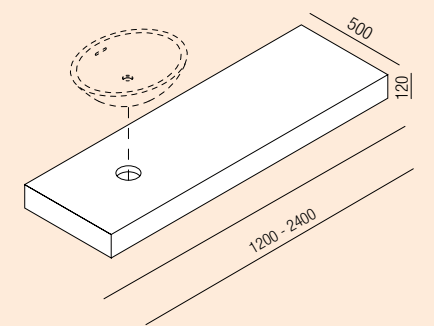

12 cm
Countertop with fitted edge / Piano con bordo attrezzato

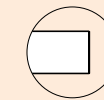

Finishes of drawer front / Finiture frontali



AX1_

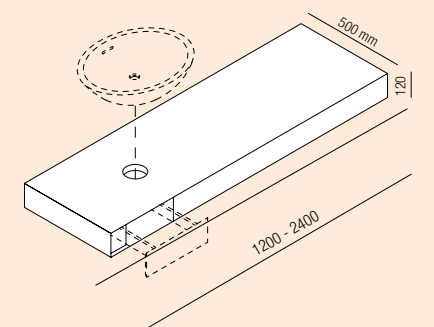

Flat XL

Countertop / Piano per lavabo



Immersion – washbasin / lavabo
 Flat XL – countertop / piano
 Lato – storage unit / contenitore
 Fez 2 – taps / rubinetteria
 Dot line – mirror / specchio
 Dot line – accessories / accessori

Flat XL

Countertop / Piano per lavabo



Cube – washbasin / lavabo
 Flat XL – countertop / piano
 Sen – taps / rubinetteria
 4x4 – mirror cabinets / specchi contenitori
 Sen – accessories / accessori

The drawers, hidden in the thickness of the top, have a width of 40, 60, 80, 100 cm in the same finishes as the top / I cassetti, nascosti nello spessore del piano, hanno larghezza di 40, 60, 80, 100 cm nelle stesse finiture del piano

Flat XL

Countertop / Piano per lavabo

Spoon XL – washbasin / lavabo
Flat XL – programme / programma



Flat XL

Countertop / Piano per lavabo

Drop – washbasin / lavabo
Flat XL – programme / programma
Square – taps / rubinetteria
Nudo LED – mirror / specchio



Flat XL

Countertop / Piano per lavabo



Spoon XL - washbasins / lavabi
Flat XL - programme / programma
Sen - taps / rubinetteria
Nudo - mirror / specchio
Sen - accessories / accessori

Flat XL

Countertop / Piano per lavabo

- Spoon XL - washbasin / lavabo
- Flat XL - countertop / piano
- Lato - storage unit / contenitore
- Fez 2 - taps / rubinetteria
- Spin - mirror / specchio



Flat XL

Countertop / Piano per lavabo

- Vieques - washbasin / lavabo
- Flat XL - programme / programma
- Fez 2 - taps / rubinetteria



Petra

Countertop / Piano per lavabo

Petra, self-bearing countertop realised in Cementoskin®, new type of concrete, resistant to any kind of dirt and with unique aesthetic features. The entire collection is inspired by the soft and natural finish of this material. The self-bearing countertop has no cut out to fit the washbasin. This can be done during installation by the customer.

Petra, piano autoportante realizzato in Cementoskin®, cemento resistente a qualsiasi tipo di sporco e con caratteristiche estetiche uniche. La finitura superficiale risulta naturale e vellutata, e ispira l'intera collezione. Il piano autoportante non presenta forature per il posizionamento del lavabo, queste possono essere eseguite liberamente in opera da parte del cliente.

☀️ ACER093_

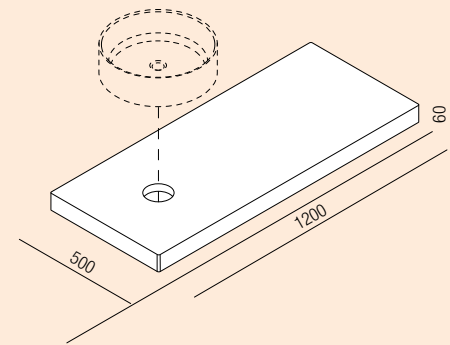

180



110



540



570



730

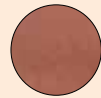

design Diego Vencato, Marco Merendi, 2018



Petra

Countertop / Piano per lavabo



Petra – washbasin / lavabo
 Petra – countertop / piano
 Square – taps / rubinetteria
 369 – dispenser for soap / dispenser per sapone

Sanitary ware / Sanitari

Agape sanitary ware is highly original in terms of design, decoration and materials. Products featuring rounded shapes with simple, clean lines, in tune with a wide variety of styles of living and of interior design.

I sanitari Agape possiedono una forte originalità nel disegno, nei decori e nei materiali. Proposte caratterizzate da forme arrotondate da linee essenziali, in sintonia con diversi modi di vivere e d'arredare.



Sanitary ware / Sanitari

Shapes / Forme

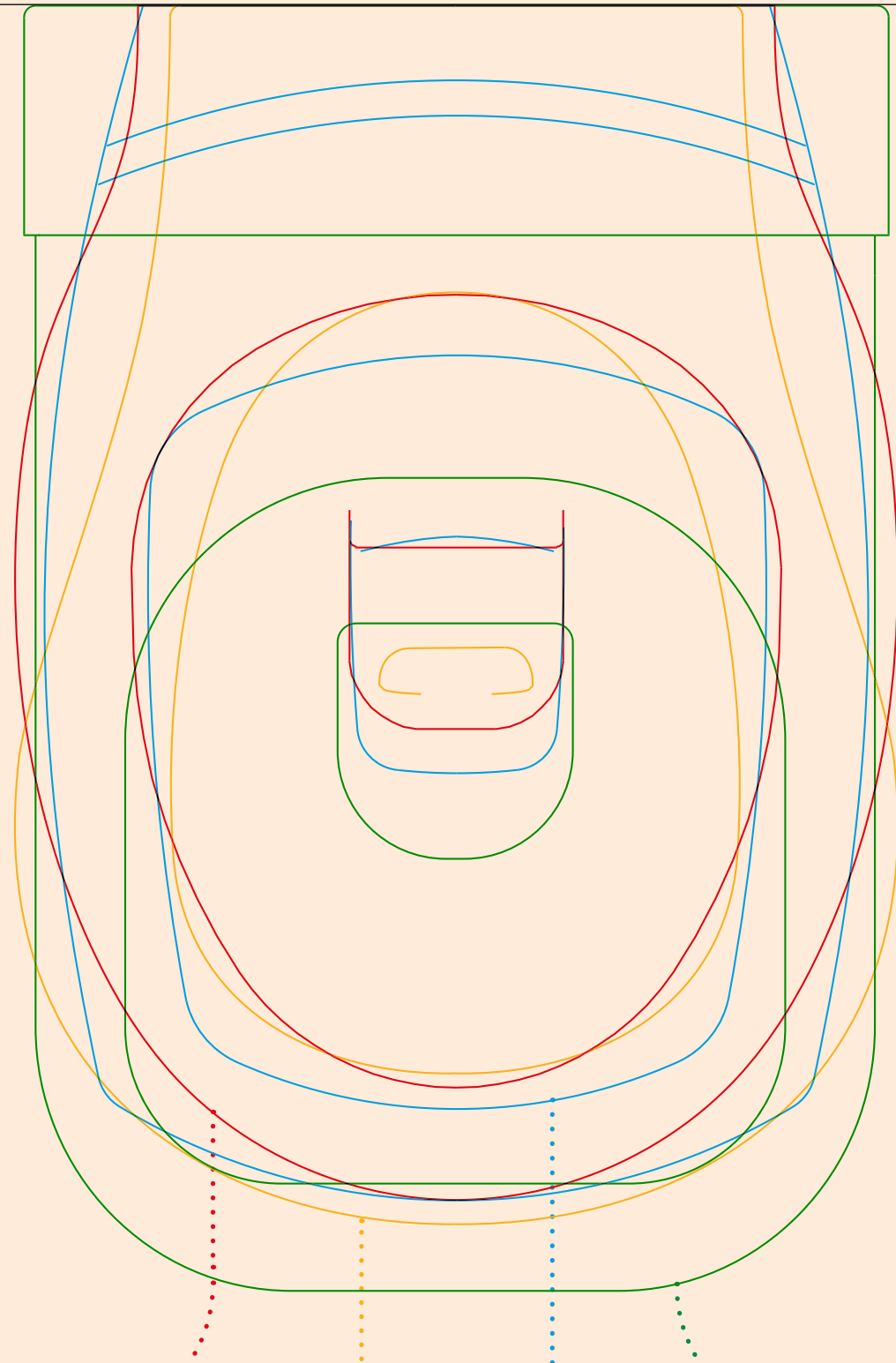

Pear 2 / rimless

Pear / rimless

750 / rimless

..... Memory

floor standing /
da appoggio

wall mounted /
sospesi

750

p. 114

Memory

p. 116

Pear

p. 118

Pear 2

p. 120

Rimless sanitary ware

Rimless sanitary wares come without the internal rim or "frame" and represent the evolution of the traditional toilet combining design and functionality. Lower water consumption, ease of cleaning, silence and more compact dimensions are just some of the advantages of our new rimless bathroom fixtures, also revised in their aesthetics by the hands of their designers.

The flow of water plays a fundamental role in rimless sanitary wares: water comes out of a single hole and flows along the perimeter guided by the geometric shape of the basin itself to finally flow into the drain. The circular flow is designed to ensure immediate cleaning without leaving residues, avoiding the deposit of limescale and germs on the surface.

At the moment of writing the Agape catalogue includes three different rimless sanitary ware series: 750, Pear e Pear 2.

Sanitari rimless

I sanitari rimless, così chiamati perché senza brida, quindi senza la "cornice" interna, rappresentano l'evoluzione del vaso tradizionale e sono in grado di coniugare design e funzionalità. Minore consumo di acqua, facilità di pulizia, silenziosità e dimensioni più compatte sono solo alcune delle caratteristiche dei nostri nuovi sanitari rimless rivisti anche nell'estetica dalle matite sapienti dei loro designer.

Il flusso dell'acqua gioca un ruolo fondamentale nei sanitari rimless: fuoriesce da un unico foro e scorre lungo il perimetro guidata dalla conformazione geometrica dell'invaso stesso per confluire infine nello scarico. Il flusso circolare è progettato per assicurare una pulizia immediata senza lasciare residui, evitando il deposito di calcare e germi sulla superficie.

Attualmente il catalogo Agape comprende tre famiglie di sanitari rimless: 750, Pear e Pear 2.

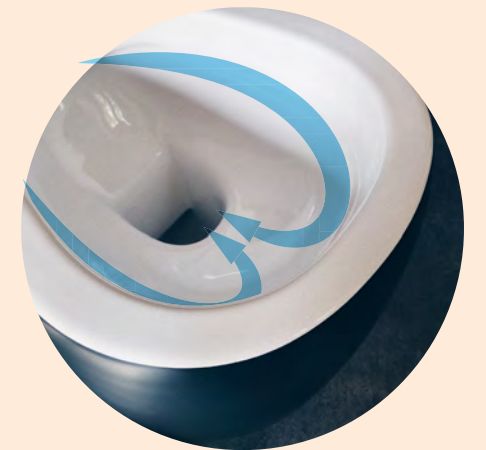

750

Wall mounted / Sospesi

Pure and simple ceramic shapes for furnishing the bathroom: this is the philosophy of the 750 sanitary ware collection, made in ceramic as wall-mounted version. Benedini Associati revisits 750 by interpreting the pure and essential shapes of the collection in more compact dimensions. Available in all glossy or matt white on the outside.

Pure ed essenziali forme in ceramica per arredare il bagno: questa è la filosofia della collezione di sanitari 750, realizzati in ceramica in versione sospesa. Benedini Associati rivisita 750 interpretando in forme più compatte le forme pure ed essenziali della collezione. Disponibili in versione completamente bianca lucida o opaca all'esterno.

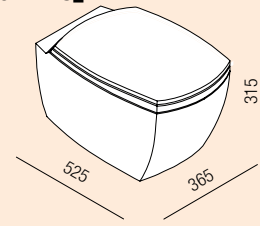
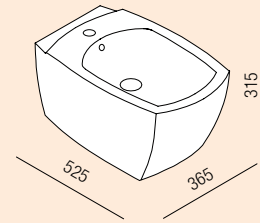
ACER0750WRRS_
RIMLESS**ACER0750BSR_**

design Benedini Associati, 2004

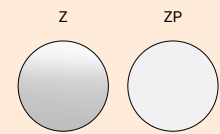
**750**

Wall mounted / Sospesi

750 – sanitary ware / sanitari
Square – taps / rubinetteria
Hydro – hydrobrush / idroscopino



Memory

Floor standing / Da appoggio

The sanitary ware of Memory collection is an interpretation of the atmosphere of traditional bathrooms, idealising the curvy forms of bygone times to create a new fusion between past and present. Available in glossy or matt white (only on the outside) ceramic or two-colour with light or dark grey outside, in the freestanding version.

I sanitari della collezione Memory interpretano l'atmosfera delle sale da bagno tradizionali, idealizzando le forme sinuose del passato per dare vita ad una nuova sintesi fra memoria e attualità. Disponibili nella versione da terra in ceramica lucida o opaca (solo sulla parte esterna) o bicolore con esterno grigio chiaro o grigio scuro.

ACER0898W_

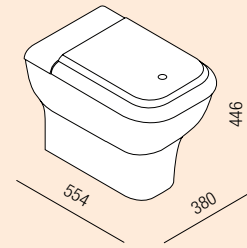

ACER0898B_

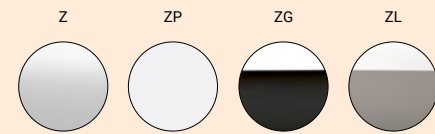
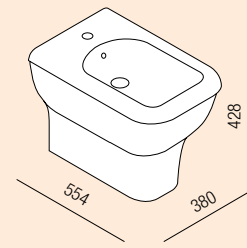

design Benedini Associati, 2010



Memory

Floor standing / Da appoggio

Memory – sanitary ware / sanitari
Memory – taps / rubinetteria
Memory – accessories / accessori



Pear

Wall mounted / Sospesi

The distinctive shape of the items in the Pear collection is a feature that defines the entire bathroom space, adding freshness, originality and user friendliness.

The sanitary ware is available in an all glossy white version or matt or two-coloured dark grey exterior.

Pear, designed by Patricia Urquiola, becomes more compact in the rimless version while reinterpreting its sinuous shapes.

L'inconfondibile forma degli elementi della collezione Pear, è un segno che caratterizza l'intero ambiente bagno, rendendolo fresco, originale e amichevole.

I sanitari sono disponibili in versione tutta bianca lucida o opaca o bicolore con esterno grigio scuro.

Pear, disegnato da Patricia Urquiola, nella versione rimless diviene più compatto reinterpretando le sue forme sinuose.

ACER0895WRR_ RIMLESS

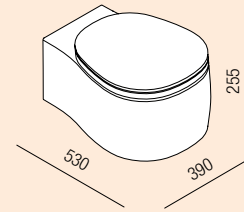

ACER0895BR_

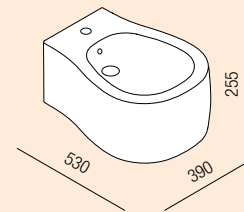

Selected "ADI DESIGN INDEX" 2005
Selected "EDIDA" 2008

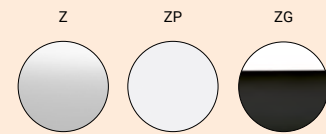

design Patricia Urquiola, 2004



Pear

Wall mounted / Sospesi

Pear – sanitary ware / sanitari
Sen – taps / rubinetteria
Sen – accessories / accessori



Pear 2

Wall mounted / Sospesi

The rimless Pear 2 sanitary ware echoes the design of the Pear collection, interpreting it however with a more streamlined shape. Available in the wall-mounted type, it is available in all glossy or matt white, a bathroom classic, or in a two-colour version, to create a dynamic visual effect. Now also available in the colored version both internally and externally with green or dark grey finish, with seat in the same color.

I sanitari Pear 2 rimless riprendono il design della collezione Pear, interpretandola però con una forma più snella.

Proposti nella tipologia sospesa, si presentano in tonalità completamente bianca lucida o opaca, un classico dell'ambiente bagno, oppure in versione bicolore, per creare un dinamico effetto visivo. Ora sono disponibili anche nella versione colorata sia internamente che esternamente con finitura verde o grigio scura, con sedile nello stesso colore.

ACER0897WR_
RIMLESS

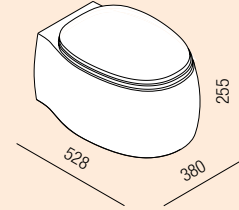

ACER0897B_

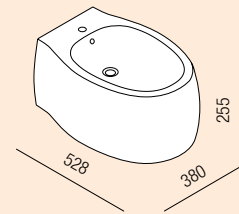

design Patricia Urquiola, 2010

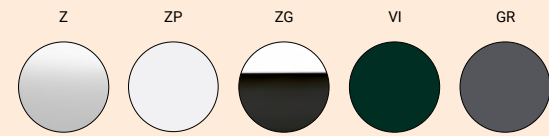

Pear 2

Wall mounted / Sospesi

Pear 2 – sanitary ware / sanitari
Fez 2 – taps / rubinetteria



Bathtubs / Vasche

Immerse yourself in a world of possibilities and sensations, with Agape bathtubs. Classic yet contemporary shapes and state-of-the-art materials such as solid surface Cristalplant® biobased and stainless steel add an extra sensory dimension, and offer innovative advantages in quality, durability and looks.

Immergetevi in un mondo di possibilità ed emozioni, con le vasche da bagno Agape. Forme classiche ed allo stesso tempo contemporanee, materiali innovativi come il solid surface, il Cristalplant® biobased, il legno waterproof, l'acciaio inox, per introdurre ulteriori sensazioni e offrire innovativi vantaggi: nella qualità, nella durata, nell'estetica.



freestanding /
freestanding

built-in /
a incasso

01. Cuna	p. 126	
02. DR	p. 128	p. 130
02. DR Cemento	p. 131 ☀	p. 132 ☀
03. Drop	p. 134	
04. Immersion	p. 135	
05. In-Out	p. 136	
05. In-Out Marmo	p. 138	
05. In-Out Cemento	p. 139 ☀	
06. Lariana	p. 142	
07. Neb	p. 144	
08. Normal	p. 146	
09. Ottocento	p. 148	p. 150
10. Ottocento Small	p. 151	
11. Spoon M	p. 152	
12. Spoon XL	p. 154	
13. Ufo	p. 156 ☀	
14. Vieques	p. 158 ☀	
15. Vieques XS	p. 160 ☀	

☀ Items marked with this symbol are part of the Outdoor Collection and can also be used outdoors / Gli articoli contrassegnati con questo simbolo fanno parte della Collezione Outdoor e possono essere utilizzati anche all'esterno

Bathtubs / Vasche

An alphabet of different postures / Un alfabeto di posture diverse

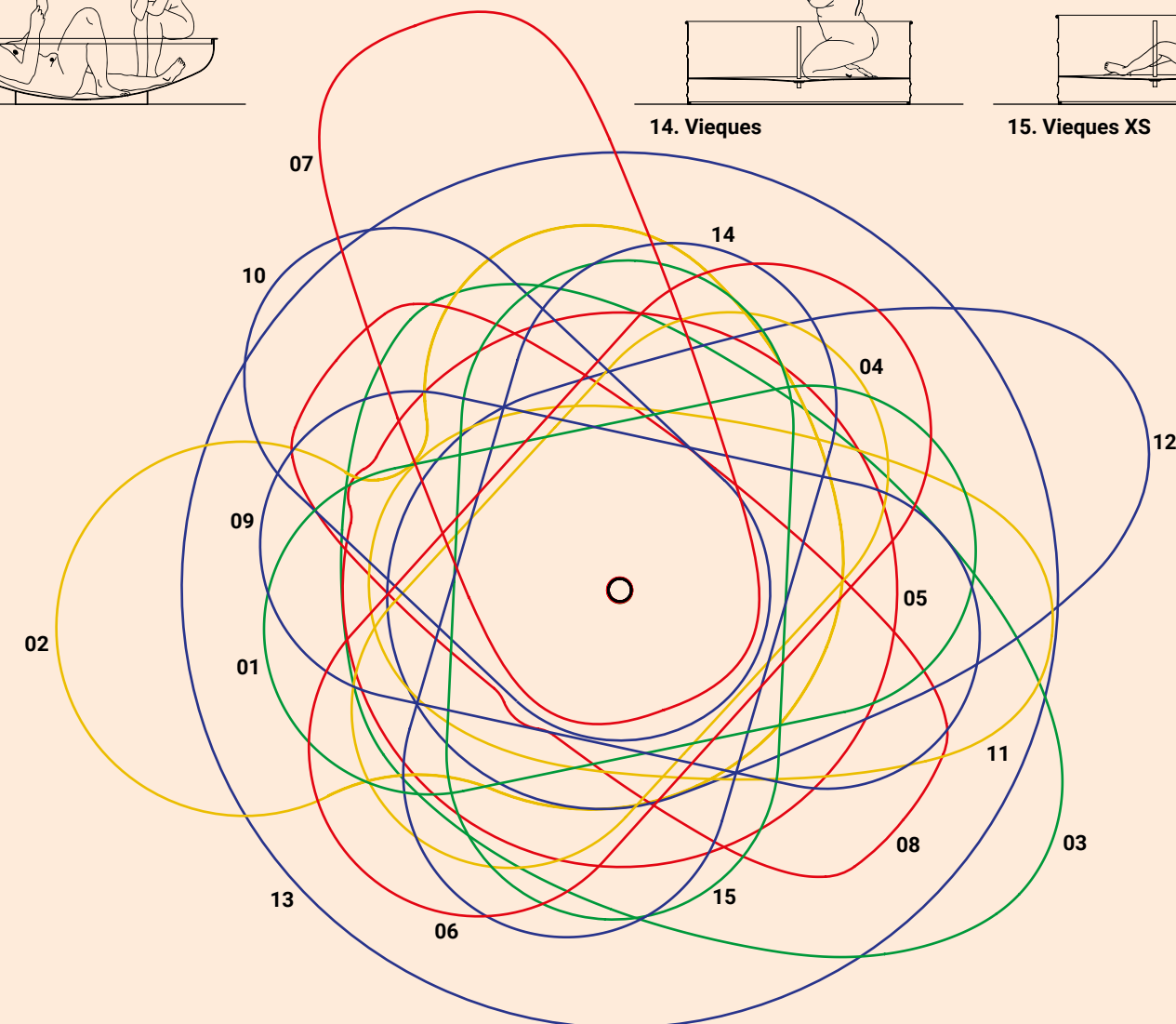
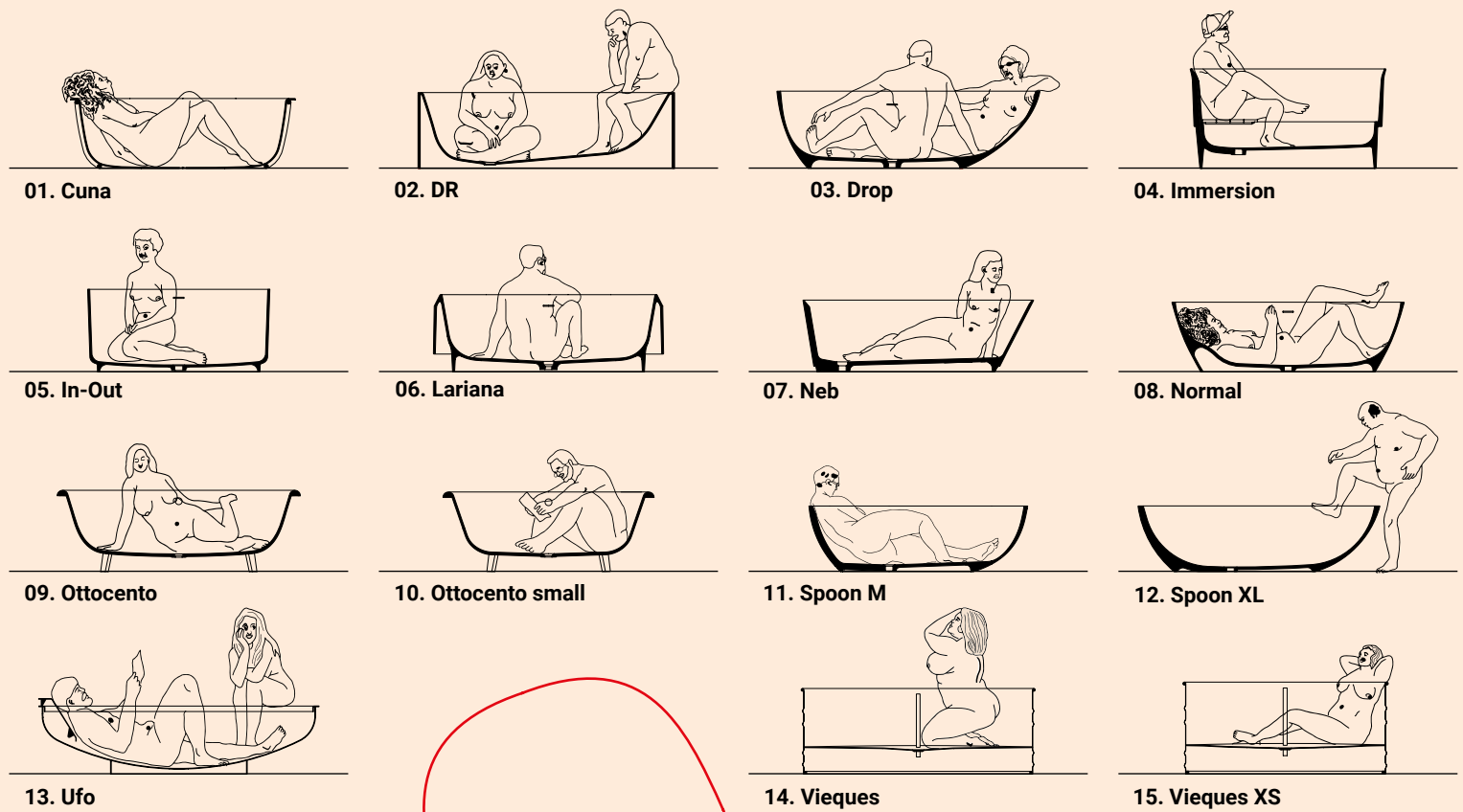

Cuna

Freestanding bathtub / Vasca freestanding

Designed with an in-depth knowledge of the materials and production processes, the Cuna bathtub is made of white thermoformed solid surface or light grey or dark grey outside, with a tubular stainless steel structure white, light grey or black lacquered or in brushed burnished finish. This small and compact bathtub showcases its structure emphasising its delicately rounded shapes.

Bathtub finishings / Finiture vasca

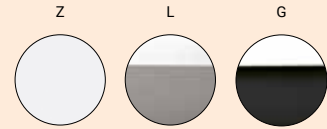

Structure finishings / Finiture struttura

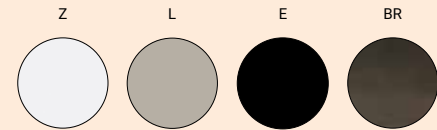

Progetto frutto di un'approfondita conoscenza dei materiali e dei processi di produzione, la vasca Cuna è realizzata in solid surface termoformato bianco o con esterno grigio chiaro o scuro, con struttura portante in tubolare d'acciaio verniciato in bianco, grigio chiaro, nero o brunito spazzolato. Compatta e di dimensioni ridotte, la vasca esibisce con orgoglio la sua struttura sottolineando le sue delicate forme tondeggianti.

AVAS1079_

Winner "THE BEST BATH & MATERIALS DESIGN"
EDIDA China 2016

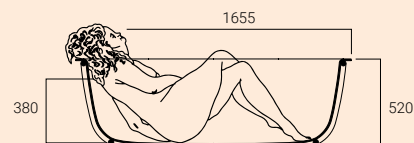
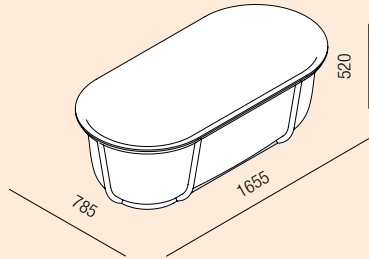

design Patricia Urquiola, 2015



Cuna

Freestanding bathtub / Vasca freestanding

Cuna – bathtub / vasca
Fez 2 – taps / rubinetteria



DR

Freestanding bathtub / Vasca freestanding

The first project in collaboration with Marcio Kogan and Studio MK27. DR is a flexible tub for two. To quote the designers, "The intention is to create a friendly, sensual and charismatic object. The smooth, flowing lines of DR offer great versatility. Take your place, and welcome!". Made of bent wood outside and solid surface inside, with wall or floor mounted taps.

Primo progetto realizzato in collaborazione con Marcio Kogan e lo studio MK27. Vasca flessibile a due sedute. Citando le parole degli autori "l'intenzione è quella di creare un oggetto amichevole, sensuale e carismatico. Le linee morbide e sinuose di DR offrono molteplici possibilità di utilizzo. Prendi posto, sei il benvenuto!". Realizzata in legno curvato all'esterno e in solid surface all'interno, con rubinetteria posizionabile a parete o a terra.

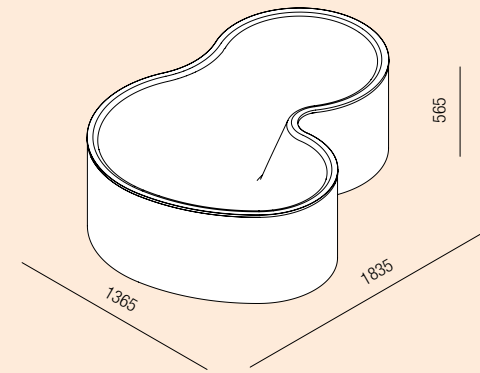
AVAS1090Z_**Interior finishings / Finiture interne**

Z

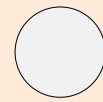

Selected "FX INTERN. INTERIOR DESIGN" 2015
Selected "ADI DESIGN INDEX" 2015
Selected "THE PLAN AWARD" 2017

External finishings / Finiture esterne

R

U

W

PT

Z

GC

GS

L

G

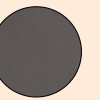
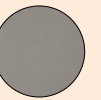
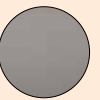
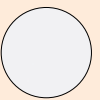
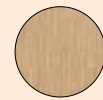

design Studio MK27, Mariana Ruzante, Marcio Kogan, 2014

**DR**

Freestanding bathtub / Vasca freestanding

DR – bathtub / vasca
 Stairs – extra / complemento



DR

Built-in bathtub / Vasca ad incasso

Built-in bathtub in white solid surface without structure. Water supply also possible from the inside of the bathtub thanks to a hole equipped with polished stainless steel ring. DR built-in bathtub maintains its original sensual shapes and flexibility in use, for two or more people, which make DR a friendly object.

Vasca in solid surface bianco ad incasso senza struttura. L'erogazione dell'acqua è possibile anche dall'interno della vasca tramite foro provvisto di ghiera in acciaio inox lucido. DR ad incasso mantiene le sue forme sensuali e la flessibilità di utilizzo per due o più persone che la rendono un oggetto conviviale.

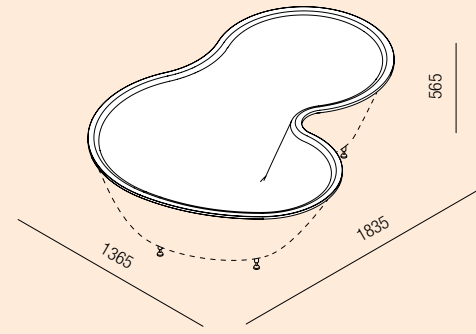
AVAS1089Z_

design Studio MK27, Mariana Ruzante, Marcio Kogan, 2014

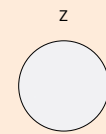
**DR Cemento**

Freestanding bathtub / Vasca freestanding

Cementoskin® bathtub (colored cement in paste) available in different colors. DR Cemento for outdoor is made in freestanding version, with or without external structure, with overflow integrated in the included chromed drain. MET0722S included, without holes for taps. The version without external structure can also be built into the floor.

Vasca in Cementoskin® (cemento colorato in pasta) disponibile in diverse colorazioni. DR Cemento per outdoor è realizzata in versione freestanding, con o senza struttura esterna, con troppo pieno integrato nella piletta cromata .MET0722S inclusa, senza fori per rubinetteria. La versione senza struttura esterna può anche essere incassata a pavimento.

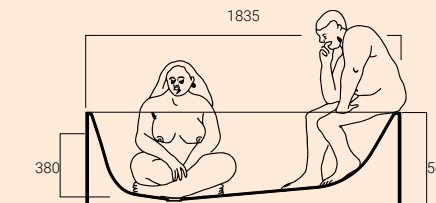
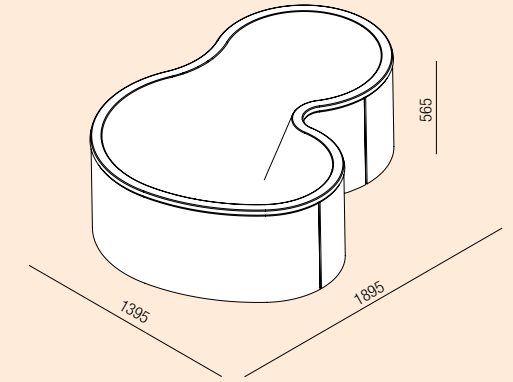
AVAS1091E_

design Studio MK27, Mariana Ruzante, Marcio Kogan, 2020



DR Cemento

Built-in bathtub / Vasca ad incasso

The version without external structure of the DR in Cementoskin® (colored cement in paste) allows it to be recessed into the floor. Available in five different colors, for outdoor use.

La versione senza struttura esterna della DR in Cementoskin® (cemento colorato in pasta) ne permette l'incasso a pavimento. Disponibile in cinque diverse colorazioni, per utilizzo Outdoor.

☀️ AVAS1092E_

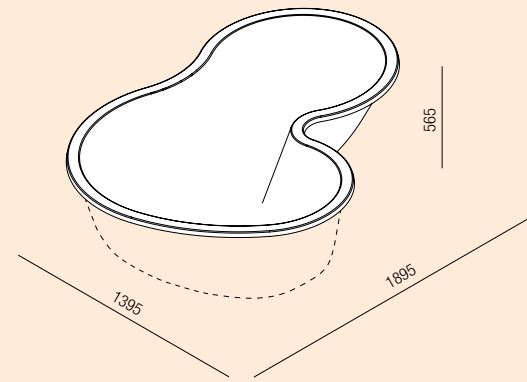

design Studio MK27, Mariana Ruzante, Marcio Kogan, 2020

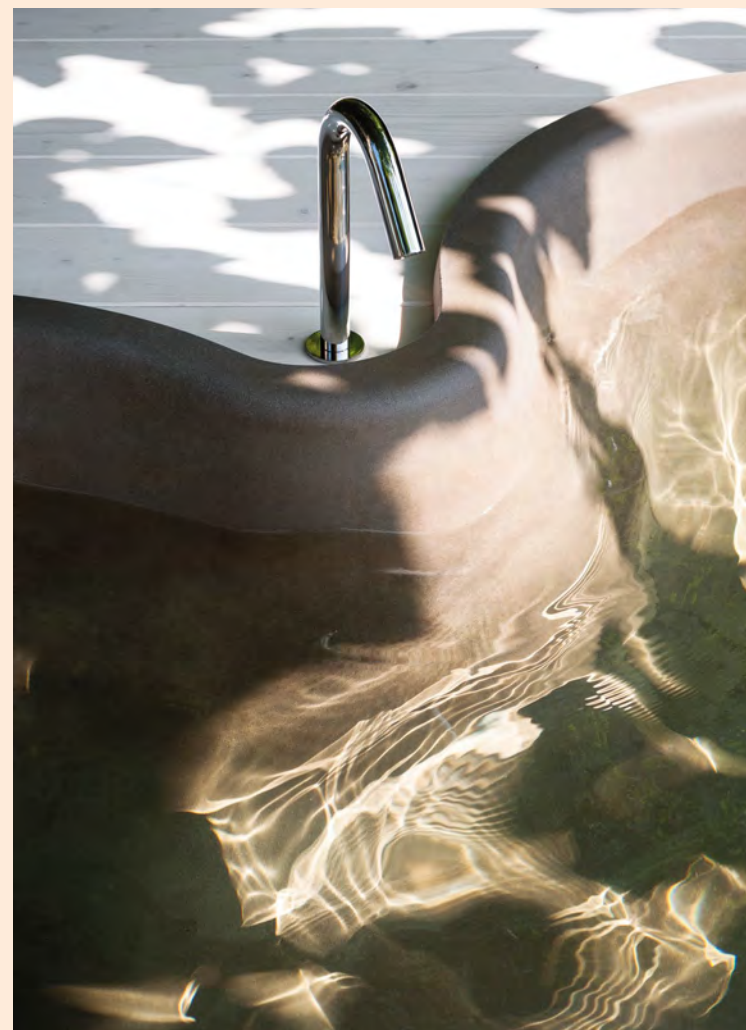
**DR Cemento**

Built-in bathtub / Vasca ad incasso

DR Cemento – bathtub / vasca
Square – taps / rubinetteria



Drop

Freestanding bathtub / Vasca freestanding

With Drop we took on the difficult task of designing a bathtub that can be used simultaneously in different positions by more than one person. Available in white or two coloured, Drop adds to the production of Agape bathtubs made of Cristalplant® biobased, a material ideally suited to responding to Drop's requirements. Completing the design project is a washbasin designed to sit on a shelf and a freestanding pedestal version.

Con Drop ci siamo avventurati nel non facile obiettivo di realizzare una vasca che possa essere utilizzata contemporaneamente, in diverse posture, da più persone. Disponibile bianca o bicolore, va ad arricchire la produzione di vasche Agape realizzate in Cristalplant® biobased, materiale dalle caratteristiche complessive perfettamente aderenti alla tipologia funzionale di Drop. Il progetto è completato da un lavabo per appoggio su piano e da una versione a colonna freestanding.

AVAS1097_

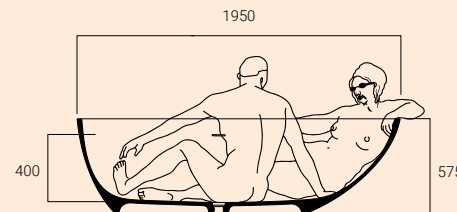
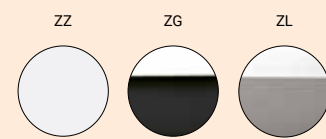
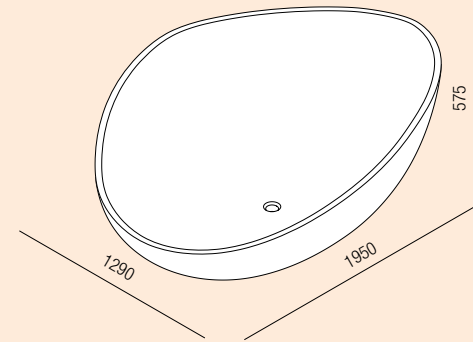

design Benedini Associati, 2014



Immersion

Freestanding bathtub / Vasca freestanding

The Immersion bathtub, inspired by traditional timber bathing vessels used in Japan and China, is deeper than a standard tub and occupies a smaller footprint. Similar to an onsen hot spring experience, it offers two posture of bathing: one more upright rather than reclined thanks to a seat realised in iroko wood positioned along one of the side; while the added depth allows a full immersion of the entire body for deep relaxation. The bathtub is made in white Cristalplant® biobased or two coloured. The bathtub can be combined with the sink of the same name.

Immersion reinterpreta le tradizionali tinozze di legno orientali ed è più profonda di una normale vasca occupando una superficie inferiore. La postura più eretta adottata all'interno della vasca ricorda l'esperienza delle stazioni termali onsen. La vasca permette due differenti posizioni, una più sollevata grazie ad una seduta in legno iroko posizionata su uno dei lati, l'altra completamente immersi favorendo la sensazione di relax. La vasca è realizzata in Cristalplant® biobased bianco o bicolore. La vasca può essere abbinata all'omonimo lavabo.

AVAS1981_

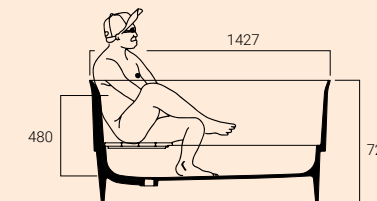
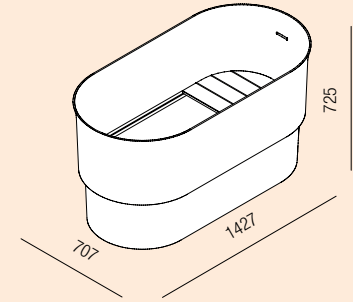

Winner "NYCxDESIGN AWARD" 2017
 Winner "EDIDA" China 2017
 Winner "EDIDA" ELLE DECOR INTERNATIONAL 2018
 Winner "NYCxDESIGN AWARD" 2020

design Neri&Hu, 2017



In-Out

Freestanding bathtub / Vasca freestanding

In-Out, the bathtub with a round footprint in white or two-tone solid surface with a marked personality. The elementary geometry makes the In-Out tub extremely versatile in the most diverse architectural situations. The taps can be positioned on the wall or on the floor.

In-Out, la vasca con invaso tondo in solid surface bianco o bicolore dalla personalità marcata. La geometria elementare rende la vasca In-Out estremamente versatile nelle più diverse situazioni architettoniche. La rubinetteria è posizionabile a parete o a terra.

AVAS1041SS_

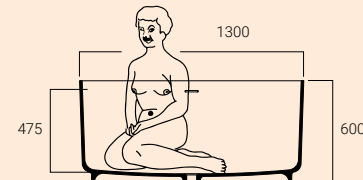
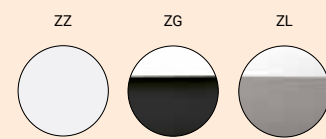
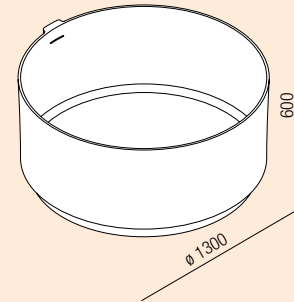

design Benedini Associati, 2009



In-Out

Freestanding bathtub / Vasca freestanding

In-Out – bathtub / vasca
Square – taps / rubinetteria



In-Out Marmo

Freestanding bathtub / Vasca freestanding

In-Out, the bathtub with its characteristic circular shape and small footprint in white Carrara marble, black Marquina, green Alpi or dark Emperador marble.

In-Out, la vasca dalla caratteristica forma circolare e l'ingombro ridotto in marmo bianco di Carrara, nero Marquina, verde Alpi o marmo Emperador dark.

AVAS1041_

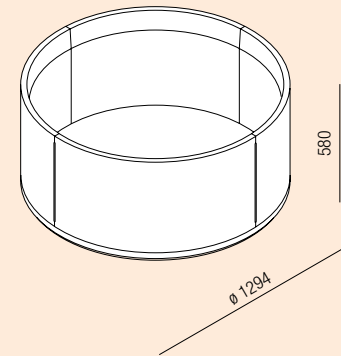

Winner "THE BEST SOAK" 2016



design Benedini Associati, 2015



In-Out Cemento

Freestanding bathtub / Vasca freestanding

In-Out in concrete is the latest addition to the In-Out bathtub family. Made in Cementoskin®, it retains the circular shape and the reduced footprint of the other tubs of the family. Thanks to the use of concrete, this version is also suitable for both indoor and outdoor use.

La vasca In-Out in cemento è l'ultima aggiunta alla famiglia di vasche In-Out. Realizzata in Cementoskin®, mantiene la forma circolare e l'ingombro ridotto delle altre vasche della famiglia. Grazie all'uso del cemento, questa versione è adatta per l'uso interno ed esterno.

AVAS1041E_

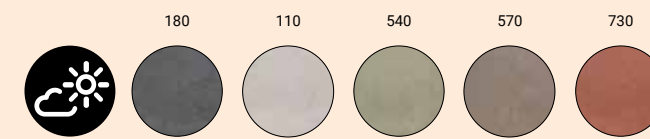
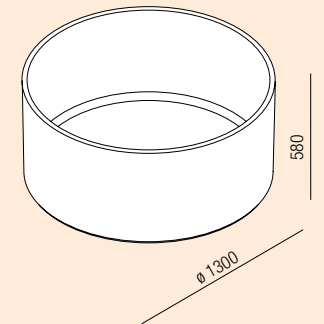

design Benedini Associati, 2021



In-Out

Freestanding bathtub family / Famiglia di vasche freestanding

AVAS1041SS_

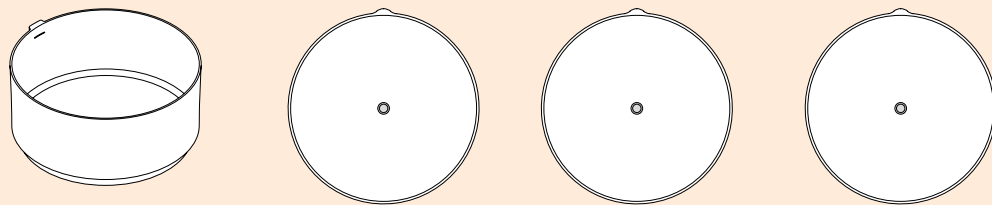

Solid surface
ø 1300, H 600

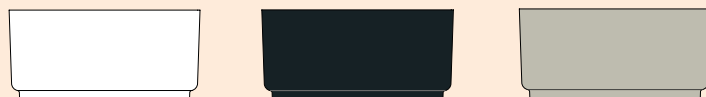

AVAS1041_



Marble / Marmo
ø 1294, H 580



AVAS1041E_

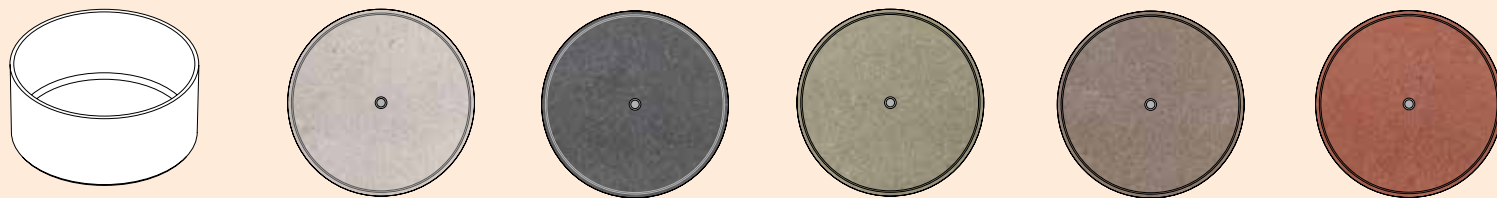

Cementoskin®
ø 1300, H 580



In-Out

Three shapes, three materials / Tre geometrie, tre materiali

AVAS1041SS_



AVAS1041_



AVAS1041E_



Lariana

Freestanding bathtub / Vasca freestanding

Lariana is a compact bathtub of reduced dimensions. This feature, combined with double wrapping, gives lightness to the solid structure and accentuates the linear form of this modern product. The bathtub is made of white Cristalplant® or in two-tone with light or dark grey exterior and can be matched with the washbasin in the same finishes.

Lariana è una vasca compatta, di misura ridotta. Questa caratteristica, unita al doppio involucro di cui è composta, conferisce leggerezza alla solida struttura ed accentua la forma lineare e moderna del prodotto. La vasca è realizzata in Cristalplant® bianco o bicolore con esterno grigio chiaro o grigio scuro ed abbinabile al lavabo nelle medesime finiture.

AVAS1080_

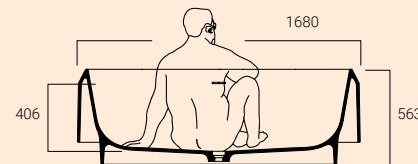
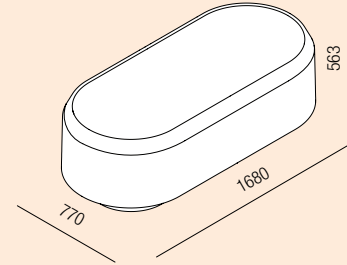

design Patricia Urquiola, 2015



Lariana

Freestanding bathtub / Vasca freestanding

Lariana – bathtub / vasca
Fez 2 – taps / rubinetteria
Gemma – extra / complemento



Neb

Freestanding bathtub / Vasca freestanding

The Neb bathtub, with its asymmetric shape, flat bottom and slimline sides, has incorporated the recent developments in the use of Cristalplant® biobased. Ultra-light and easy to install, the bathtub is available in white or a two-colour finish in light grey or dark grey. The bathtub can be combined with the sink of the same name.

La vasca Neb con la sua forma asimmetrica, il suo fondo piatto e i suoi bordi dallo spessore ridottissimo, fa suoi i più recenti sviluppi nel campo della lavorazione del Cristalplant® biobased. Estremamente leggera e facile da installare, la vasca è disponibile bianco o bicolore grigio chiaro o scuro. Abbinabile al lavabo disponibile nelle medesime finiture.

AVAS1095_

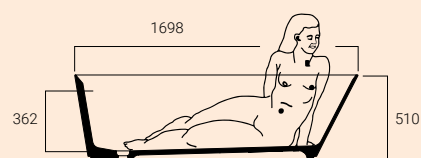
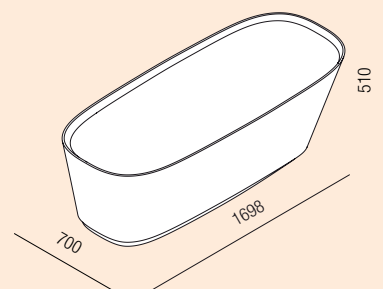

design Benedini Associati, 2018



Neb

Freestanding bathtub / Vasca freestanding

Neb – bathtub / vasca
Memory – taps / rubinetteria
Ascension – extra / complemento



Normal

Freestanding bathtub / Vasca freestanding

The immense pleasure of immersing oneself takes on a new dimension with Normal. This model, made in white Cristalplant® biobased or in two-coloured finish in light grey or dark grey, retains the cosy and welcoming form that characterises the entire collection, but in a more compact size and with a more rounded profile at the base.

This means that it fits easily into a wider variety of environments, saving space without in any way detracting from aesthetic appearance or well-being.

The bathtub can be combined with the sink of the same name.

Il profondo piacere di immergersi entra in una nuova dimensione con Normal. Questo modello, realizzato in Cristalplant® biobased bianco o bicolore grigio chiaro o grigio scuro, mantiene una forma avvolgente e accogliente caratteristica dell'intera collezione, con dimensioni più ridotte e con un profilo più arrotondato alla base.

Questo consente una facile collocazione negli ambienti più diversi, risparmiando spazio senza nulla togliere all'estetica ed al benessere.

Abbinabile al lavabo disponibile nelle medesime finiture.

AVAS0910_

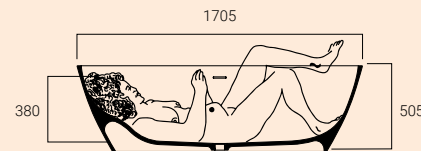
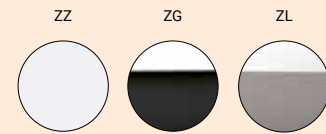
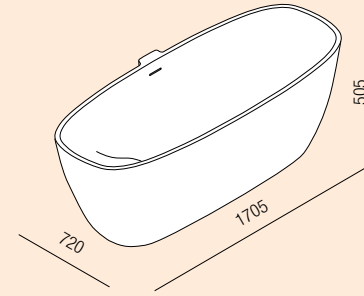

design Benedini Associati, 2008



Normal

Freestanding bathtub / Vasca freestanding

Normal – bathtubs / vasche
Square – taps / rubinetteria



Ottocento

Freestanding bathtub / Vasca freestanding

Cristalplant® biobased bathtub, a modern composite material, with a soft and silky touch that contains the warmth of the water. The bathtub follows the classic lines based on the design of the old-fashioned, cast iron bathtub, supported on four feet; these feet are in the same material as the bathtub. Also available in version with outside painted in dark grey or light grey. Exposed drainpipe and overflow system. The bathtub can be combined with the sink of the same name.

Vasca in Cristalplant® biobased, un materiale composito morbido e setoso al tatto che mantiene il calore dell'acqua. La vasca segue le linee classiche che riprendono il concetto della vasca in ghisa sorretta da quattro piedi; questi sono realizzati nello stesso materiale della vasca. Possibile anche la variante con esterno verniciato in grigio scuro o grigio chiaro. Scarico e circuito del troppo pieno a vista. Abbinabile al lavabo disponibile nelle medesime finiture.

AVAS0969_

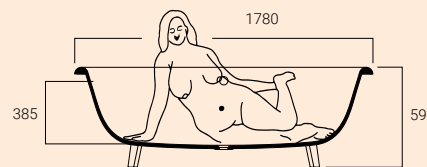
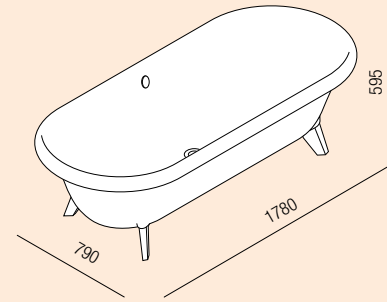

design Benedini Associati, 2010



Ottocento

Freestanding bathtub / Vasca freestanding

Ottocento – bathtub / vasca
Square – taps / rubinetteria
Stairs – extra / complemento



Ottocento

Built-in bathtub / Vasca ad incasso

A bathtub inspired by the forms of the past, interpreted in the light of an essential and actual aesthetics. Contrary to the old bathtubs in cast iron, Ottocento is made of Cristalplant® biobased, a modern composite material, with a soft and silky touch that contains the warmth of the water. The unmistakable profile of this built-in Ottocento bathtub becomes an integral part of the architecture in this bathroom.

Una vasca ispirata alle linee di un passato remoto, interpretata alla luce di un'estetica essenziale ed attuale; diversamente dalle antiche vasche in ghisa, Ottocento è realizzata in Cristalplant® biobased un moderno materiale composito morbido e setoso al tatto che mantiene il calore dell'acqua. La linea inconfondibile della vasca Ottocento diventa parte integrante dell'architettura del bagno, nella versione a incasso.

AVAS0968ZZ_

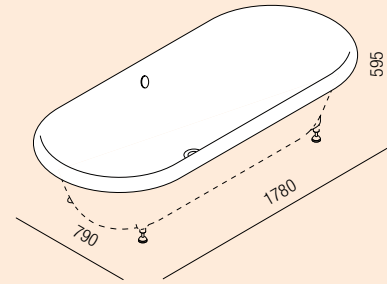

design Benedini Associati, 2010

ZZ

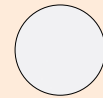

Ottocento Small

Freestanding bathtub / Vasca freestanding

A bathtub inspired by the forms of the past, interpreted in the light of an essential and actual aesthetics. Contrary to the old bathtubs in cast iron, Ottocento is made of Cristalplant® biobased, a modern composite material, with a soft and silky touch that contains the warmth of the water. With a 154 cm of length, Ottocento Small is perfect for small rooms, available in completely white, or two-coloured white and light or dark grey.

Una vasca ispirata alle linee di un passato remoto, interpretata alla luce di un'estetica essenziale ed attuale; diversamente dalle antiche vasche in ghisa, Ottocento Small è realizzata in Cristalplant® biobased un moderno materiale composito morbido e setoso al tatto che mantiene il calore dell'acqua. Lunga 154 cm è ideale per ambienti compatti, disponibile in versione completamente bianca, oppure bicolore in grigio chiaro e grigio scuro.

AVAS0967_

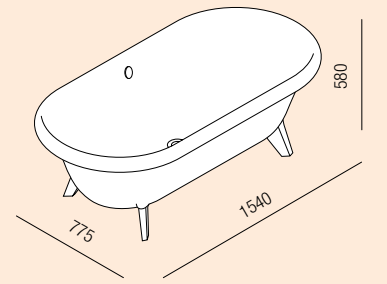

design Benedini Associati, 2013

ZZ

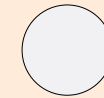

ZG



ZL

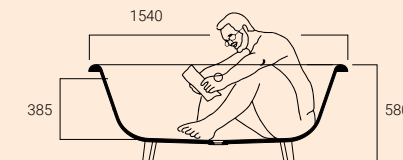

Spoon M

Freestanding bathtub / Vasca freestanding

Spoon M is one of the latest stations in a more than twenty year long evolution of the Agape bathtub through form, matter and size, tirelessly iterating and refining the underlying concepts over and over again. The new bathtub refines the formal, dimensional and material qualities of the iconic Spoon, on sale since 1998. More sophisticated geometries, thinner edges marry a more frugal use of materials, fully exploiting the latest advances in manufacturing technologies. Spoon M is made in Cristalplant® biobased and it is available in white or two-tone versions in light or dark grey.

Spoon M è una delle tappe più recenti di una ricerca che dura da oltre 20 anni e attraversa forma, materia e dimensione in un percorso evolutivo della vasca Agape che, con instancabile meticolosità, procede volentieri per iterazioni successive. La nuova vasca affina le qualità formali, dimensionali e materiali dell'icona Spoon, a listino dal 1998. Geometrie più sofisticate, spessori più sottili si sposano con un uso parsimonioso del materiale approfittando delle potenzialità offerte dai nuovi metodi di produzione. Spoon M è realizzata in Cristalplant® biobased ed è disponibile bianca o bicolore con esterno grigio chiaro o grigio scuro.

AVAS1093_

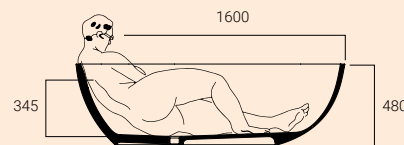
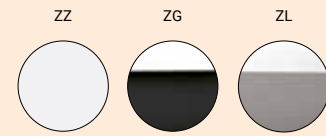
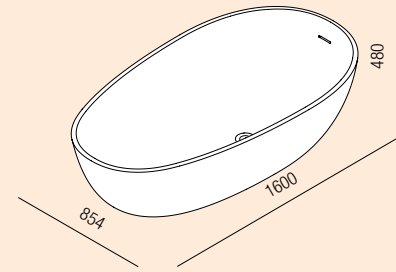

design Benedini Associati, 2019



Spoon M

Freestanding bathtub / Vasca freestanding

Spoon M – bathtub / vasca
 Square – taps / rubinetteria
 Ell – washbasin-countertop / piano lavabo
 Lato – storage unit / contenitore
 X – towel holder / porta salviette



Spoon XL

Freestanding bathtub / Vasca freestanding

Spoon XL is deeper than the original Spoon bathtub, and features an even more minimal design. It adapts easily to the widest variety of settings, and is made of white Cristalplant® biobased, a warm, pleasingly tactile material.

The Spoon XL bathtub it is available in white or two tone versions in dark or light grey. The bathtub can be combined with the sink of the same name.

Rispetto alla vasca Spoon, il modello Spoon XL ha un invaso più profondo e un design ancora più minimale. Facilmente ambientabile nei contesti più svariati, Spoon XL è realizzata in Cristalplant® biobased bianco, un materiale caldo e piacevole al tatto. Spoon XL è disponibile bianca o nella versione bicolore, con esterno grigio scuro e grigio chiaro. Abbinabile al lavabo disponibile nelle medesime finiture.

AVAS0916_

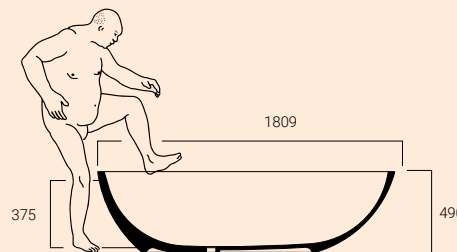
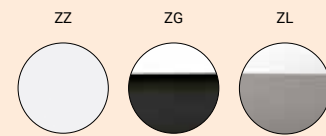
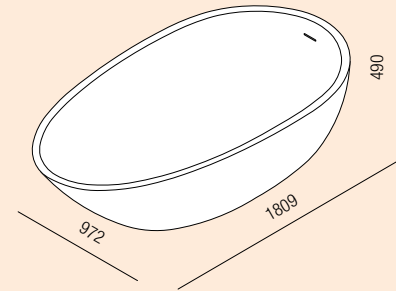

design Benedini Associati, 2005



Spoon XL

Freestanding bathtub / Vasca freestanding

Spoon XL – bathtub / vasca
Fez 2 – taps / rubinetteria
Pic-nic – towel holder / porta salviette



Ufo

Freestanding bathtub / Vasca freestanding

The Ufo bathtub surprises and enhances every context in which it is featured and finds the perfect location both in closed spaces and outside.

Between the walls, on a terrace as in a garden, its large stainless steel disk has a bicoloured finish with white inner side and dark grey outside, with one or two backrests in white Cristalplant® outdoor.

La vasca Ufo sorprende ed esalta ogni contesto in cui è inserita e trova la perfetta collocazione sia in spazi chiusi che all'esterno. Tra le mura di casa, su un terrazzo come in un giardino, il suo ampio disco in acciaio inox è capace di accogliere più persone. In versione bicolore con interno bianco ed esterno grigio scuro con uno o due poggiaschiena in Cristalplant® outdoor bianco.

AVAS0906_
AVAS0906D_
AVAS0906EZG
AVAS0906DEZG

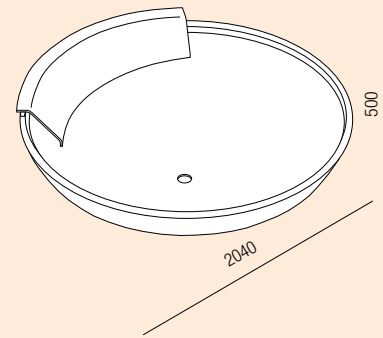

Bathtub finishings /
Finiture vasca

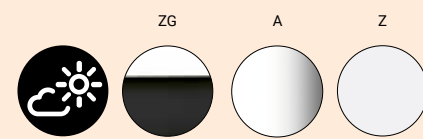

Backrest finishings /
Finiture poggiaschiena

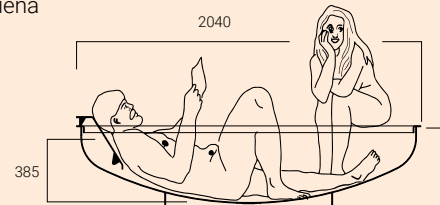

design Benedini Associati, 2002 / 2018



Ufo

Freestanding bathtub / Vasca freestanding



Ufo – bathtub / vasca
Square – taps / rubinetteria

Vieques

Freestanding bathtub / Vasca freestanding

In 2008, the wellness oasis on Vieques Island where Patricia Urquiola designed the interiors for the W Hotel, offered the inspiration for the creation of the Vieques bathtub. A ready-made tribute to the bathtub of yesteryear that has become a classic of contemporary design. Made of steel, painted in white or with a dark grey or light grey exterior, it can be completed with an iroko shelf and backrest. The stainless steel version now also allows outdoor use, in combination with the washbasin of the same name.

Nel 2008 l'oasi di benessere a Vieques Island dove Patricia Urquiola firma gli interiors per il W Hotel, offre lo spunto per la realizzazione della vasca Vieques. Un omaggio ready made alla vasca da bagno d'altri tempi divenuta un classico del design contemporaneo. Realizzata in acciaio, verniciata in bianco o con esterno grigio scuro o grigio chiaro, può essere completata da una mensola e da un poggiaschiena in iroko. La versione in acciaio inox ne permette ora anche l'utilizzo outdoor, in combinazione all'omonimo lavabo.

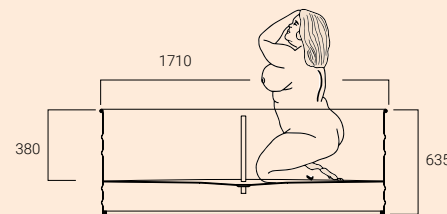
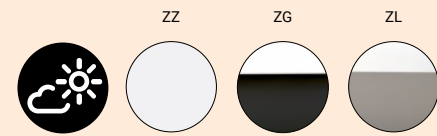

AVAS0911
AVAS0911E_

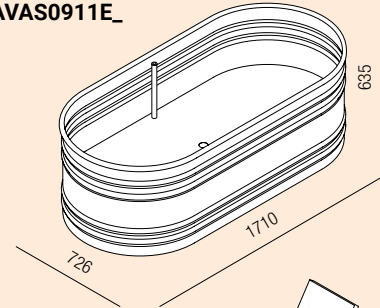

AVAS0911_I

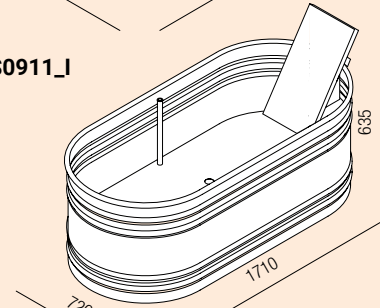

design Patricia Urquiola, 2008 / 2018



Vieques

Freestanding bathtub / Vasca freestanding

Vieques – bathtub / vasca
Fez 2 – taps / rubinetteria



Vieques XS

Freestanding bathtub / Vasca freestanding

Version with reduced dimensions of the Vieques bathtub, Vieques XS, with a length of 155 cm, allows easy insertion even in small spaces. The stainless steel version, suitable for outdoor environments, further expands the possibilities of use of this bathtub, available painted entirely in white or with dark grey or light grey exterior. Vieques XS can be combined with the washbasin of the same name, in the column or countertop version.

Versione dalle dimensioni ridotte dalla vasca Vieques, Vieques XS, con lunghezza 155 cm, permette un facile inserimento anche in spazi ridotti. La versione in acciaio inox, adatta per ambienti esterni, amplia ulteriormente le possibilità di utilizzo di questa vasca, disponibile verniciata interamente in bianco o con esterno grigio scuro o grigio chiaro. Vieques XS è abbinabile al lavabo che porta lo stesso nome, in versione a colonna o in appoggio su piano.

AVAS0912
AVAS0912E_

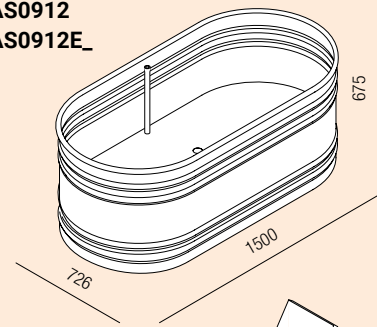

AVAS0912_I

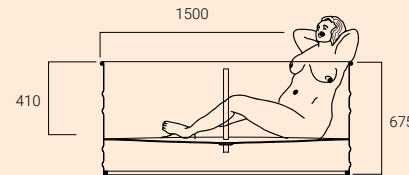
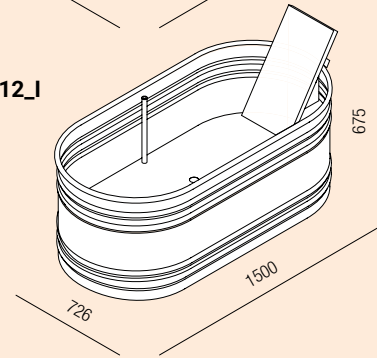

design Patricia Urquiola, 2013 / 2018

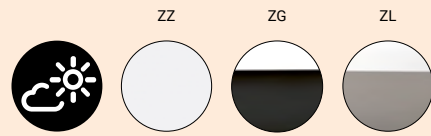

Showers / Docce

The shower as a space for personal freedom, to be designed and lived without constraint: any time, anywhere. This is the Agape philosophy, developed through a range of designs, all featuring the same trademark simplicity, lightness and luminosity.

La doccia come spazio di libertà personale, da progettare e vivere senza vincoli: in ogni istante, in qualsiasi ambiente. Questa è l'idea Agape, sviluppata in progetti diversi, sempre nel segno dell'essenzialità, della leggerezza e della luminosità.



	wall mounted / a parete	3 sided / a 3 lati	corner / ad angolo	niche / in nicchia	ceiling, closed / a soffitto, chiuse	ceiling, open / a soffitto, aperte	shower tray / piatto doccia
Amuleto							p. 188 ☀
Cooper					p. 194	p. 194	
Flat D		p. 163	p. 163	p. 163			
Flat DX		p. 170	p. 170	p. 170			
PDX							p. 186
Petra	p. 190 ☀						p.190 ☀
Plan-a			p. 176	p. 176			

Flat D

Showers / Docce

With the Flat D program, the shower is reduced to its essence in a play of layers that hints to volumes of crystalline precision. Thanks to the use of 8 mm glass, the impact of the support structures becomes minimal. The exclusive integration of the shower heads in the support bars and the possibility of recessing the guides and plates, further contribute to the reduction of the elements of the shower which can thus boast a great aesthetic and functional versatility.

The crystals are available in transparent, acid-etched, extra-clear or fumé finishes while the structural elements are in polished stainless steel or chromed brass. The openings can be hinged, sliding or with free access.

Con il programma Flat D la doccia si riduce alla sua essenza in un gioco di piani che alludono a volumi di precisione cristallina. Grazie all'utilizzo di cristalli da 8 mm di spessore per le lastre l'ingombro delle strutture di supporto diventa minimo. L'esclusiva integrazione dei soffioni nelle barre portanti e la possibilità dell'incasso delle guide e dei piatti, contribuiscono ulteriormente alla riduzione degli elementi della doccia che può così vantare una grande versatilità estetica e funzionale.

I cristalli sono disponibili nelle finiture trasparente, acidato, extrachiaro o fumé mentre gli elementi strutturali sono in acciaio inox lucido o ottone cromato. Le aperture possono essere a battente, scorrevoli o con accesso libero.

design Benedini Associati, 2002

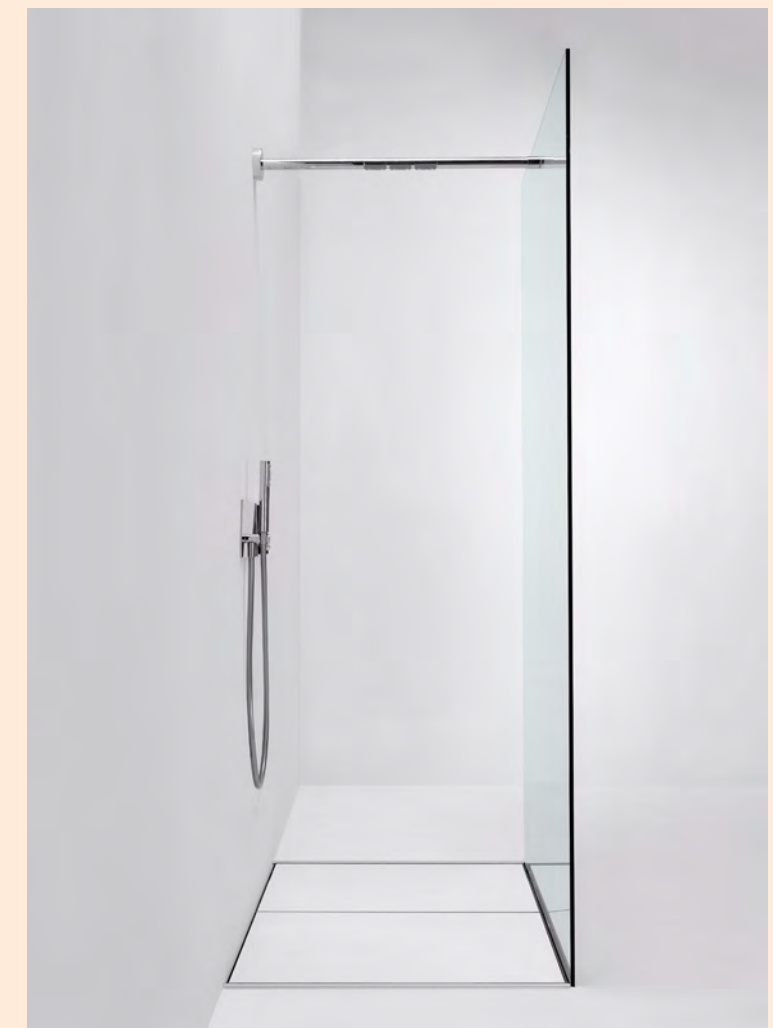

 Items marked with this symbol are part of the Outdoor Collection and can also be used outdoors / Gli articoli contrassegnati con questo simbolo fanno parte della Collezione Outdoor e possono essere utilizzati anche all'esterno

Flat D

Showers / Docce – C5

Flat D – shower / doccia
Sen – taps / rubinetteria
Sen – accessories / accessori



Flat D

Showers / Docce – C6

Flat D – shower / doccia
Fez 2 – taps / rubinetteria



Flat D

Showers / Docce

Horizontal support element hooked at the fixed wall, with possible water supply. Supply with three diffusers (a), with shower head connection (b), with no water supply (c) / Elementi di sostegno orizzontali vincolati alla parete fissa, con possibile erogazione dell'acqua. Erogazione lineare con tre diffusori (a), con attacco per soffione (b), senza erogazione (c)

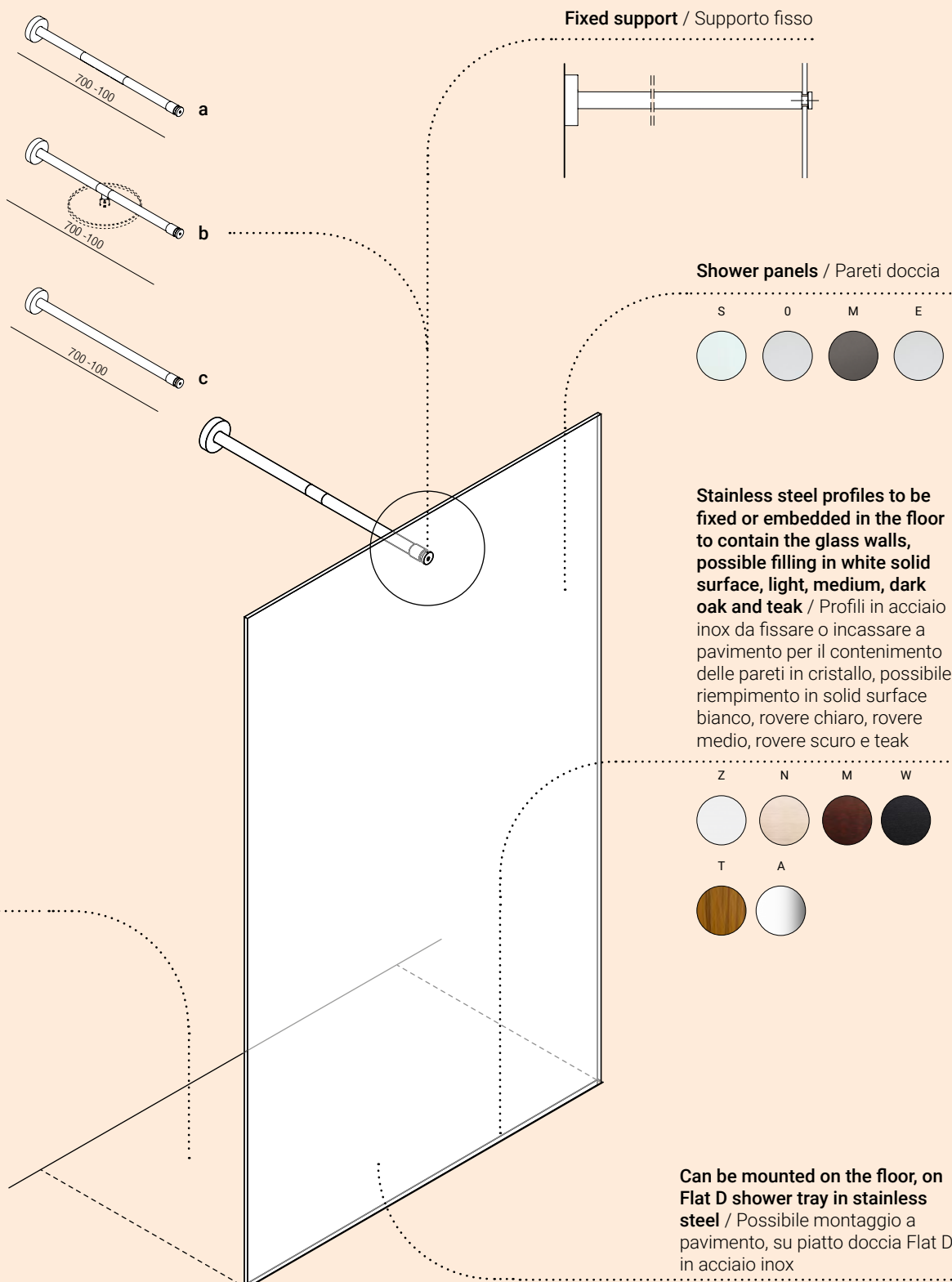

The Flat D stainless steel shower tray must be covered by a smooth or slatted platform in white solid surface, oak or teak / Il piatto doccia Flat D in acciaio inox deve essere coperto da pedana liscia o a doghe in solid surface bianco, in rovere o in teak

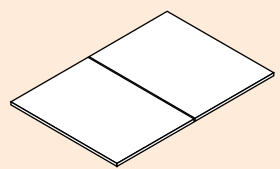
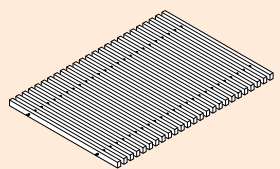

Flat D

Showers / Docce

Type / Tipologia A1

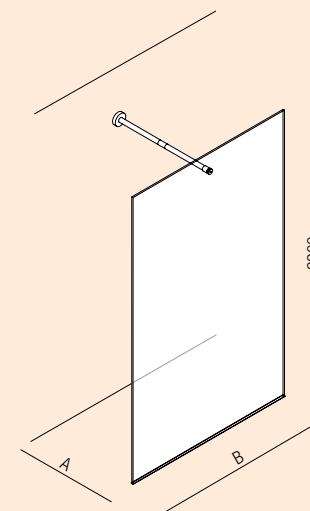

A 700 – 1000 mm
B 1000 – 1400 mm

DA10_
Fixed shower panel with horizontal support element / Parete doccia fissa con elemento di sostegno orizzontale

Type / Tipologia A2

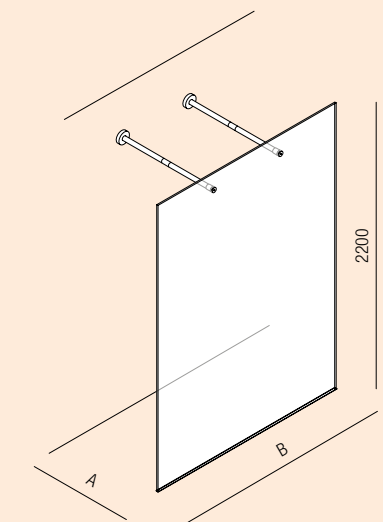

A 700 – 1000 mm
B 1400 – 1618 mm

DA20_
Fixed shower panel with two horizontal support elements / Parete doccia fissa e due elementi di sostegno orizzontali

Type / Tipologia C1

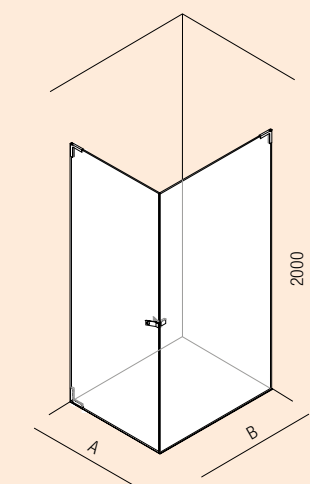

A 700 – 1000 mm
B 700 – 950 mm

DC10_
Shower cubicle with fixed wall and door with right or left opening, for corner shower / Cabina doccia con parete fissa e porta con apertura a destra o a sinistra, per doccia ad angolo

Type / Tipologia C2

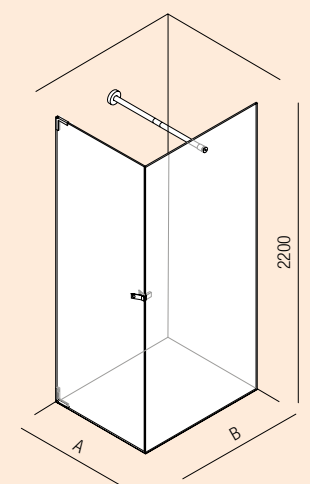

A 700 – 1000 mm
B 700 – 1400 mm

DC20_
Shower cubicle with fixed wall, horizontal support element and right or left opening door for corner showers / Cabina doccia con parete fissa, elemento di sostegno orizzontale e porta con apertura a destra o a sinistra; per doccia ad angolo

Flat D

Showers / Docce

Type / Tipologia C3

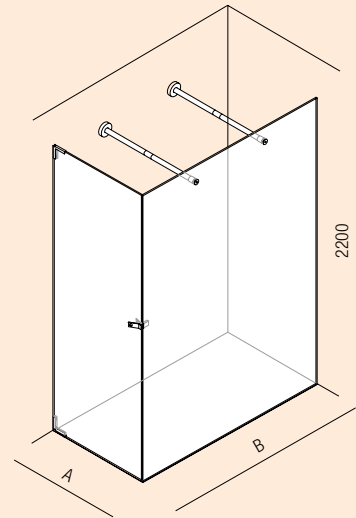

A 700 – 1000 mm
B 1400 – 1600 mm

DC30_

Shower cubicle with fixed wall, two horizontal support elements and right or left opening door for corner shower / Cabina doccia con parete fissa, due elementi di sostegno orizzontali e porta con apertura a destra o a sinistra; per doccia ad angolo

Type / Tipologia C4

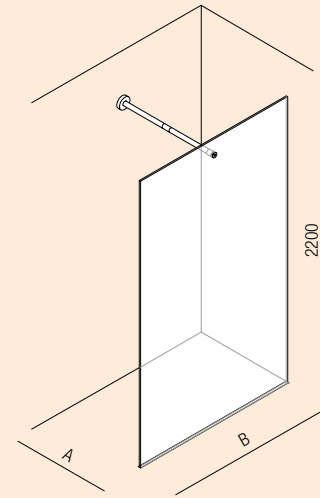

A 700 – 1000 mm
B 1000 – 1400 mm

DC40_

Fixed shower wall with one horizontal support element, for corner shower / Parete doccia fissa con elemento di sostegno orizzontale; per doccia ad angolo

Type / Tipologia C5

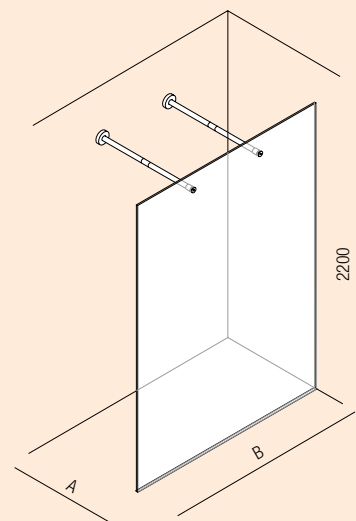

A 700 – 1000 mm
B 1400 – 1600 mm

DC50_

Fixed shower wall with two horizontal support elements, for corner shower / Parete doccia fissa con due elementi di sostegno orizzontali; per doccia ad angolo

Type / Tipologia C6

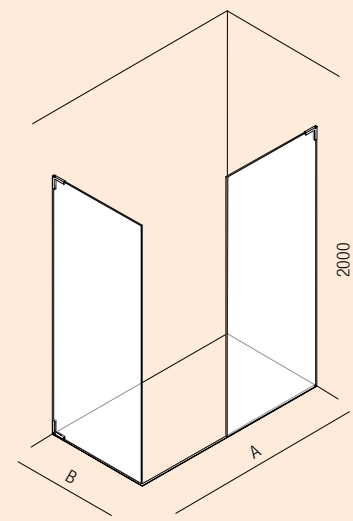

A 1400 – 1600 mm
B 700 – 900 mm

DC60_

Shower cubicle with two fixed walls for corner shower, central access opening / Cabina doccia con due pareti fisse per doccia ad angolo, accesso centrale libero

Flat D

Showers / Docce

Type / Tipologia F1

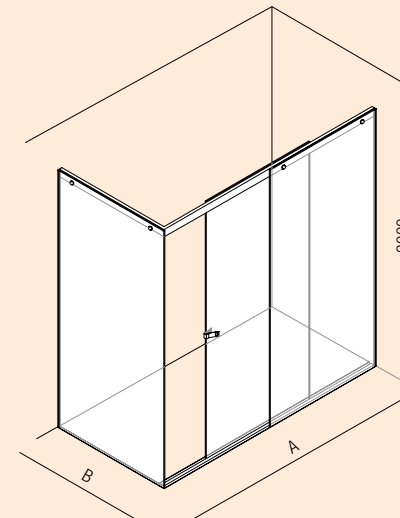

A 1200 – 2000 mm
B 700 – 1000 mm

DF10_

Shower cubicle with fixed walls and sliding door for corner shower / Cabina doccia con pareti fisse e porta scorrevole per doccia ad angolo

Type / Tipologia B1

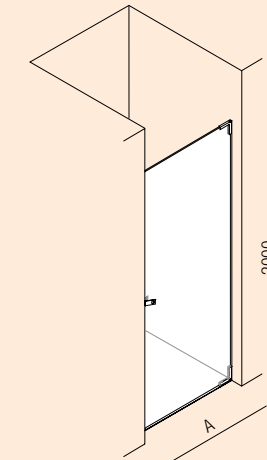

A 682 – 1000 mm

DB10_

Door for niche shower with right or left opening / Porta per doccia in nicchia con apertura a destra o a sinistra

Type / Tipologia E1

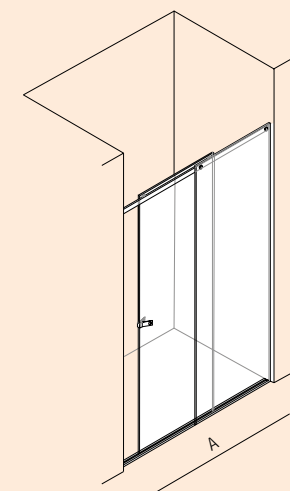

A 1182 – 1800 mm

DE10_

Sliding door for niche shower / Porta scorrevole per doccia in nicchia

Type / Tipologia E2

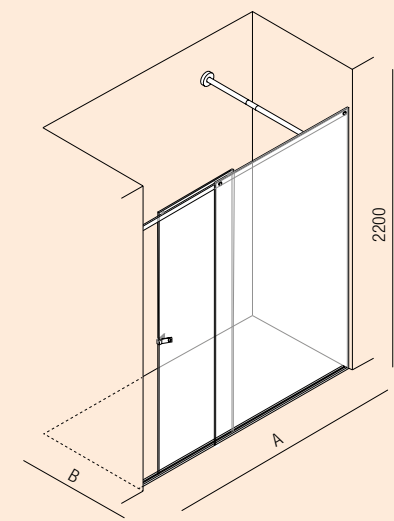

A 1800 – 2400 mm
B 700 – 1000 mm

DE20_

Sliding door for niche shower with one horizontal support element / Porta scorrevole per doccia in nicchia con elemento di sostegno orizzontale

Flat DX

Showers / Docce

The Flat DX program combines the lightness and clean lines of Flat D showers with great ease of installation that does not require masonry work. The 8 mm glass panels are supported by vertical profiles to be fixed to the masonry, without the need for recessing. The exclusive integration of the shower heads in the support bars and the ability to position them freely along the entire length of the glass further contribute to the reduction of the elements of the shower which can thus boast great aesthetic and functional versatility.

The crystals are available in transparent, acid-etched, extra-clear or smoked finishes while the structural elements are in polished stainless steel or chromed brass. The openings can be hinged or with free access.

Il programma Flat DX unisce la leggerezza e la pulizia delle docce Flat D ad una grande facilità di installazione che non necessita di opere murarie. Le pareti in cristallo da 8 mm sono sostenute da profili verticali da fissare alla muratura, senza bisogno di incasso. L'esclusiva integrazione dei soffioni nelle barre portanti e la possibilità di posizionare le stesse liberamente su tutta la lunghezza del vetro contribuiscono ulteriormente alla riduzione degli elementi della doccia che può così vantare una grande versatilità estetica e funzionale.

I cristalli sono disponibili nelle finiture trasparente, acidato, extrachiaro o fumé mentre gli elementi strutturali sono in acciaio inox lucido o ottone cromato. Le aperture possono essere a battente o con accesso libero.

design Benedini Associati, 2002



Flat DX

Showers / Docce – XC2

Flat DX – shower / doccia
Fez 2 – taps / rubinetteria
369 – shelf / mensola



Flat DX

Showers / Docce

Horizontal support element hooked at the fixed wall, with possible water supply. Supply with three diffusers (a), with shower head connection (b), with no water supply (c)
 / Elementi di sostegno orizzontali agganciati alla parete fissa, con possibile erogazione dell'acqua. Con erogazione lineare con tre diffusori (a), con attacco per soffione (b), senza erogazione (c)

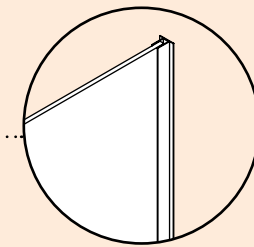
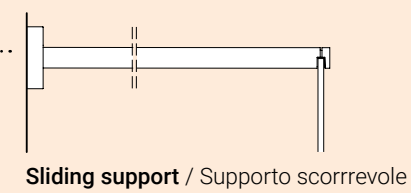
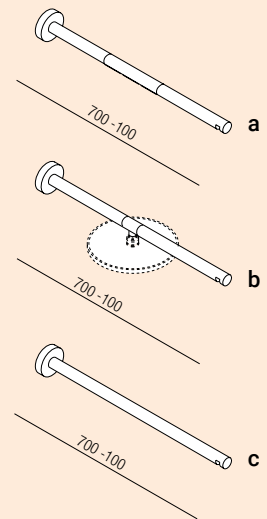

Stainless steel vertical profiles to fasten to the wall without the need of recessed installation or construction works
 / Profili verticali in acciaio inox da fissare alla parete senza bisogno di incassi ed opere murarie

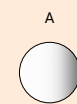

Right or left opening door / Porta con apertura a destra o a sinistra

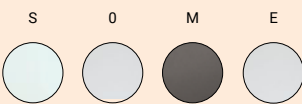

If the horizontal support element is placed in the right position, or if an additional element is used, it is possible to use the curtain
 / Posizionando in modo opportuno l'elemento orizzontale, o inserendone uno aggiuntivo, è possibile utilizzare la tenda

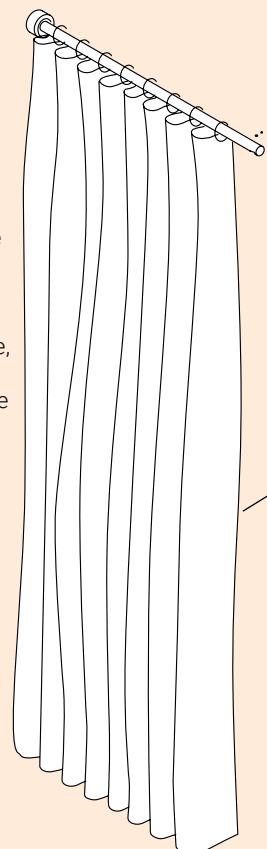

Fixed shower panel / Parete doccia fissa

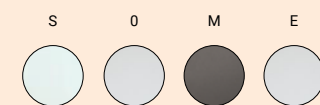

It is possible to use shower trays PDX, in ceramic or other materials
 / È possibile l'utilizzo su piatti doccia PDX, in ceramica o altro

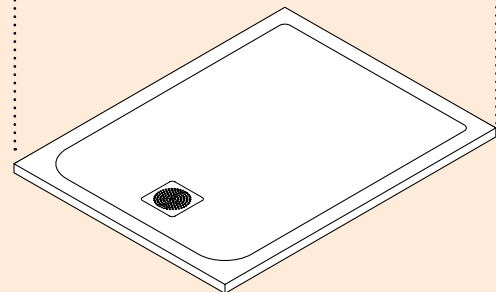

Flat DX

Showers / Docce – XG1

Flat DX – fixed wall / parete fissa
 Memory – sanitary ware / sanitari
 Memory – accessories / accessori



Flat DX

Showers / Docce

Type / Tipologia XC1

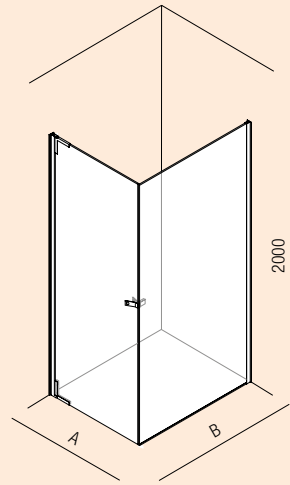

A 700 – 1000 mm
B 700 – 950 mm

DXC1_

Shower cubicle with fixed wall and right or left opening door, for corner showers / Cabina doccia con parete fissa e porta con apertura a destra o a sinistra, per doccia ad angolo

Type / Tipologia XC2

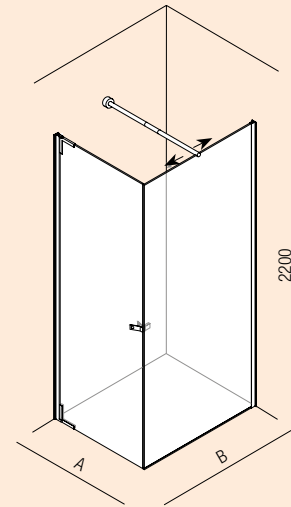

A 700 – 1000 mm
B 700 – 1400 mm

DXC2_

Shower cubicle with fixed wall, horizontal support element and right or left opening door; for corner showers / Cabina doccia con parete fissa, elemento di sostegno orizzontale e porta con apertura a destra o a sinistra, per doccia ad angolo

Type / Tipologia XC3

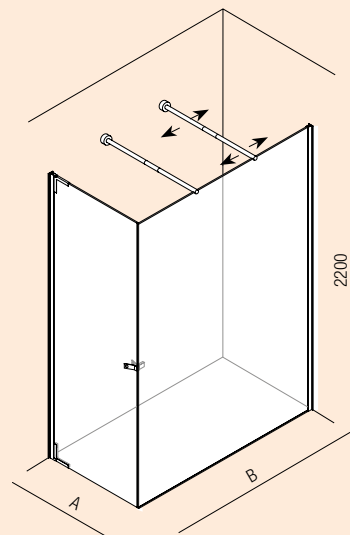

A 700 – 1000 mm
B 1400 – 1600 mm

DXC3_

Shower cubicle with fixed wall, two horizontal support elements and right or left opening door; for corner shower / Cabina doccia con parete fissa, elementi di sostegno orizzontali e porta con apertura a destra o a sinistra, per doccia ad angolo

Type / Tipologia XC4

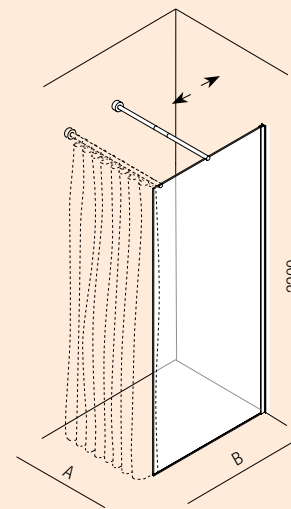

A 700 – 1000 mm
B 700 – 1400 mm

DXC4_

Fixed shower wall with one horizontal support element for corner shower / Parete doccia fissa con elemento di sostegno orizzontale per doccia ad angolo

Flat DX

Showers / Docce

Type / Tipologia XC5

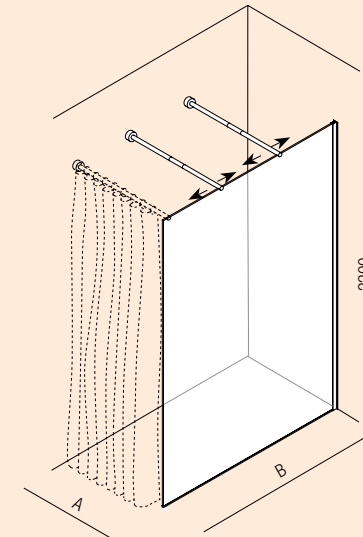

A 700 – 1000 mm
B 1400 – 1600 mm

DXC5_

Fixed shower wall with two horizontal support elements, for corner shower / Parete doccia fissa con elementi di sostegno orizzontali per doccia ad angolo

Type / Tipologia XG1

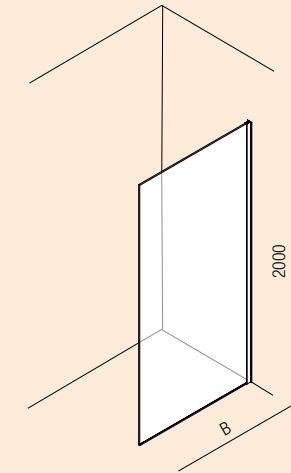

B 600 – 950 mm

DXG1_

Fixed wall / Parete fissa

Type / Tipologia XG2

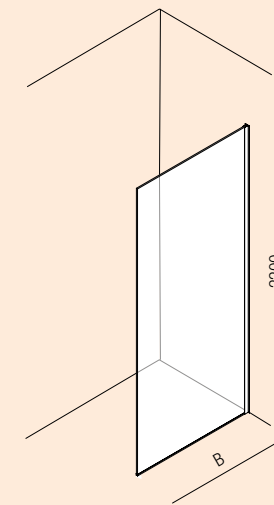

B 600 – 950 mm

DXG2_

Fixed wall / Parete fissa

Type / Tipologia XB1

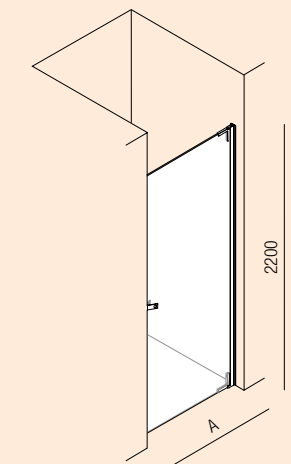

A 700 – 1000 mm

DXB1_

Door for niche shower with right or left opening / Porta per doccia in nicchia con apertura a destra o a sinistra

Plan-a

Showers / Docce

The Plan-a program reflects the long architectural tradition of the frame in the contemporary shower. A sophisticated dialogue between closures with ephemeral transparency and the almost inexorable precision of the aluminum structural elements breaks up the volume in a continuous cross-reference between elements. The structure reduced to its essence in its positioning and in its fine details acts as a discreet frame and an ideal perimeter for your daily rituals.

Plan-a is a system of walls for showers in extra-clear or smoked glass, supported by elements in natural or black brushed anodized aluminum. All the walls are designed to be installed on the floor or any type of shower tray.

Il programma Plan-a declina nella doccia contemporanea la lunga tradizione architettonica della cornice. Un sofisticato dialogo tra chiusure dalla trasparenza effimera la precisione quasi inesorabile degli elementi strutturali in alluminio scompone il volume in un continuo rimando tra elementi. La struttura ridotta alla sua essenza nel suo posizionamento e nei suoi fini dettagli fa da cornice discreta e perimetro ideale per i vostri rituali quotidiani.

Plan-a è un sistema di pareti per docce in cristallo trasparente extrachiaro o fumè, sostenute da elementi in alluminio anodizzato spazzolato naturale o nero. Tutte le pareti sono predisposte per essere installate su pavimento o qualsiasi tipo di piatto doccia.

design Giulio Gianturco, Mario Tessarollo,
2006 - 2012



Plan-a

Showers / Docce

Support profiles in natural brushed or black anodized aluminium / Profili di sostegno in alluminio anodizzato spazzolato naturale o nero

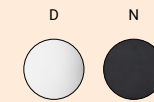

Side fixed part
/ Parte fissa laterale

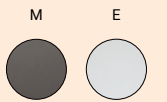

It is even possible to buy only the fittings; drawings will be supplied for the realization of glass walls by the customer / È possibile l'acquisto della sola ferramenta; saranno forniti i disegni per la realizzazione delle parti in vetro a cura del cliente

It is possible to decide the opening side of the door: right (with hinges on the right) or left (with hinges on the left) / È possibile decidere il lato di apertura della porta: destro (con cerniere a destra) o sinistro (con cerniere a sinistra)

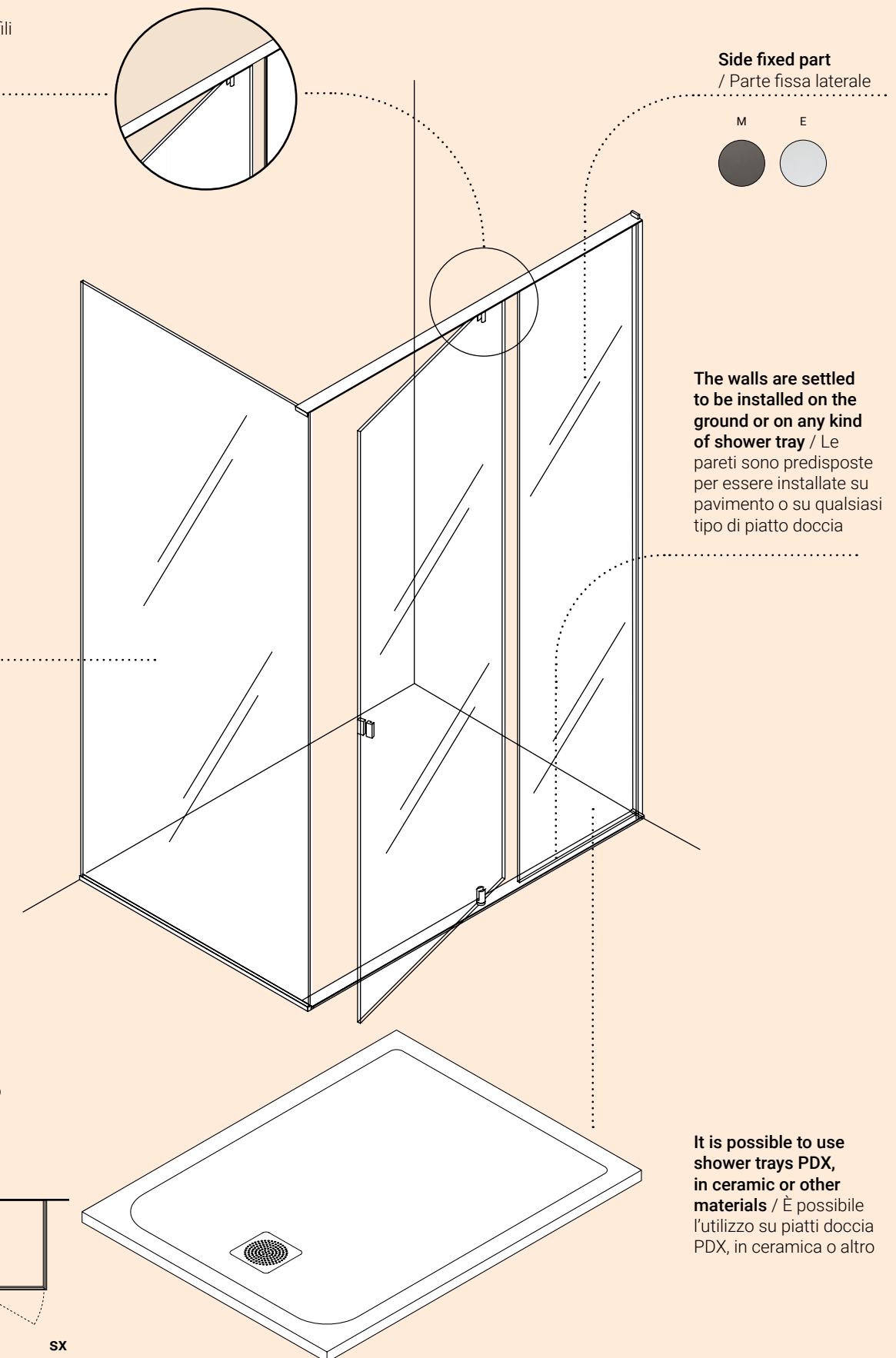
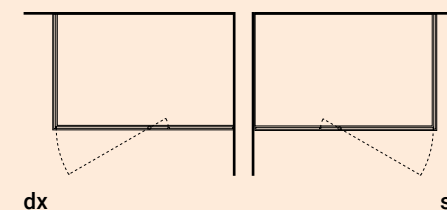

The walls are settled to be installed on the ground or on any kind of shower tray / Le pareti sono predisposte per essere installate su pavimento o su qualsiasi tipo di piatto doccia

It is possible to use shower trays PDX, in ceramic or other materials / È possibile l'utilizzo su piatti doccia PDX, in ceramica o altro

Plan-a

Showers / Docce – B1

Plan-a – shower / doccia
 Sen – taps / rubinetteria
 PDX – shower tray / piatto doccia
 Sen – accessories / accessori

**Plan-a**

Showers / Docce – C1

Plan-a – shower / doccia
 Memory – taps / rubinetteria
 PDX – shower tray / piatto doccia
 Memory – accessories / accessori



Plan-a

Showers / Docce – D1

Plan-a – shower / doccia
 Fez 2 – taps / rubinetteria
 Dot line – accessories / accessori

**Plan-a**

Showers / Docce – E1

Plan-a – shower / doccia
 Limón – taps / rubinetteria
 PDX – shower tray / piatto doccia
 Mach 2 – shelf / mensola



Plan-a

Showers / Docce – F1

Plan-a – shower / doccia
 Memory Mix – taps / rubinetteria
 PDX – shower tray / piatto doccia
 Memory – accessories / accessori

**Plan-a**

Showers / Docce



Plan-a

Showers / Docce

Type / Tipologia A1

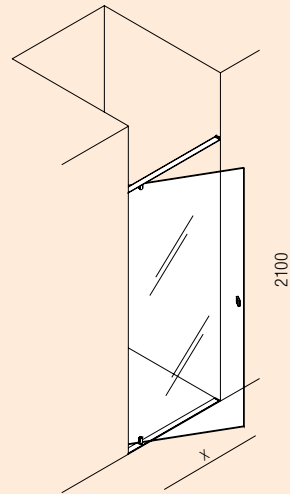

X 700 – 1000 mm

APLA1_

Door for shower in niche with swing door and hinge on the right or left / Porta per doccia in nicchia con anta a battente con cerniera a destra o a sinistra

Type / Tipologia B1

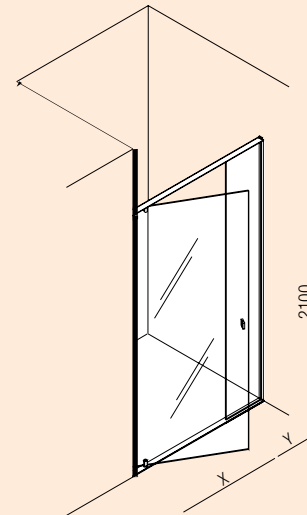
X 700 – 1000 mm
Y 300 – 1000 mm

APLB1_

Wall for shower in niche with swing door and hinge on the right or left and front fixed part, the hinge is always mounted on the masonry wall / Parete per doccia in nicchia con anta a battente con cerniera a destra o a sinistra e parte fissa frontale, la cerniera è sempre posta in corrispondenza della parete in muratura

Type / Tipologia C1

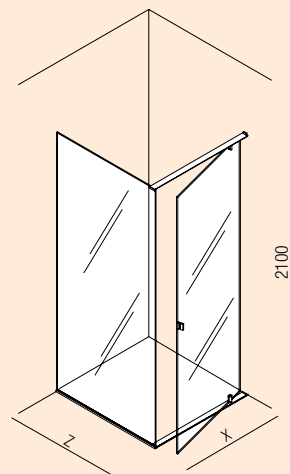
X 700 – 1000 mm
Y 700 – 1400 mm

APLC1_

Angular shower box with swing door and hinge on the right or on the left and the side fixed part, the hinge is always mounted on the masonry wall / Cabina doccia ad angolo con anta a battente con cerniera a destra o a sinistra e parte fissa laterale, la cerniera è sempre posta in corrispondenza della parete in muratura

Type / Tipologia D1

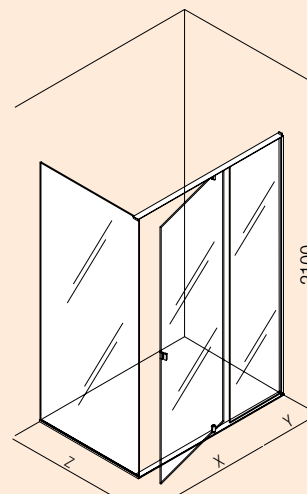
X 700 – 1000 mm
Y 300 – 1000 mm
Z 700 – 1400 mm

APLD1_

Angular shower box with swing door and hinge on the right or on the left, front fixed part aligned with the door and the side part, the hinge is mounted on the masonry wall / Cabina doccia ad angolo, anta a battente con cerniera a destra o sinistra, parte fissa frontale in linea con l'anta e parte fissa laterale, la cerniera è posta in corrispondenza della muratura

Plan-a

Showers / Docce

Type / Tipologia E

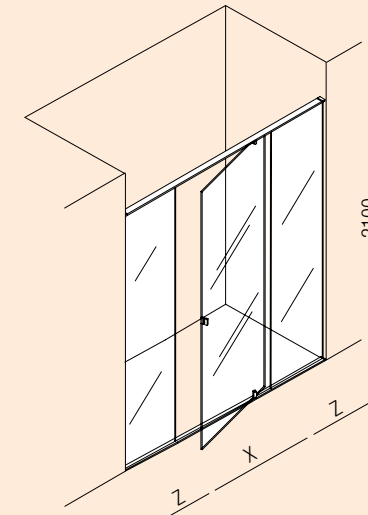
X 700 – 800 mm
Z 300 – 800 mm

APLE1_

Wall for shower in niche with swing door and hinge on the right or left and two front fixed parts, these have to be always identical to each other / Parete per doccia in nicchia con anta a battente, con cerniera a destra o a sinistra e due parti fisse frontali, queste devono sempre essere uguali tra di loro

Type / Tipologia F

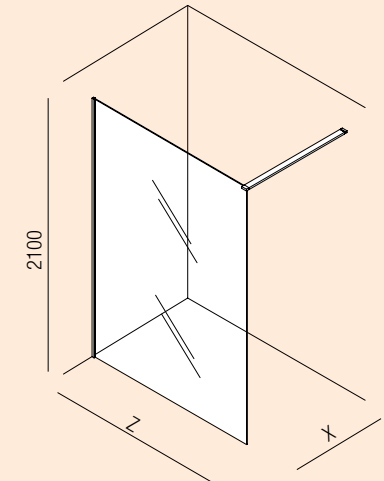
X 700 – 1000 mm
Z 700 – 1400 mm

APLF1_

Fixed shower wall, for angular shower, with left or right access / Parete fissa per doccia ad angolo con ingresso a destra o a sinistra

PDX

Shower tray / Piatto doccia

Shower tray available in white Ceramilux® with matt finish, 3 cm thickness, or in marble in white Carrara, black Marquina or grey Carnic finish, 4 cm thickness. With customisable dimensions and the possibility of inseting into the floor, this solution is highly flexible and adapts to any situation. Perfect to complete Flat D, Flat DX and Plan-a showers.

Piatto in Ceramilux® bianco con finitura opaca, con spessore di 3 cm, oppure in marmo nelle varianti bianco di Carrara, nero Marquina e grigio Carnico, con spessore di 4 cm. Il dimensionamento a misura e la possibilità di essere posizionato anche incassato nel pavimento, lo rende estremamente flessibile e adattabile ad ogni soluzione. È l'ideale completamento delle docce Flat D, Flat DX e Plan-a.

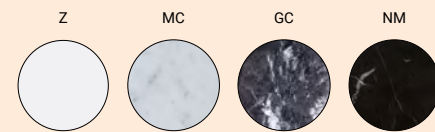
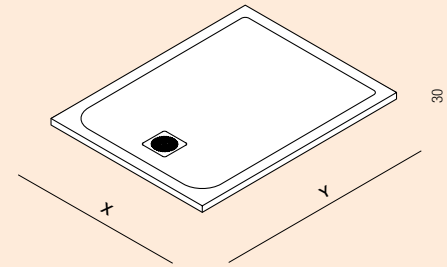

PDX

Shower tray / Piatto doccia

APDX_UB3

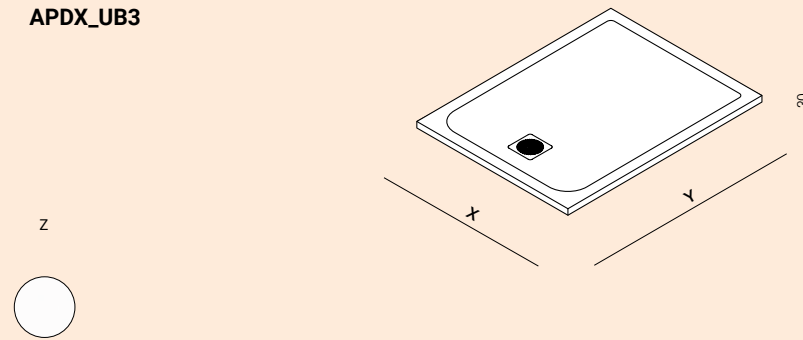

Shower tray in Ceramilux® with standard dimensions / Piatto doccia in Ceramilux® con misure standard

X 700 – 1000 mm
Y 900 – 1600 mm

APDXSRB3_

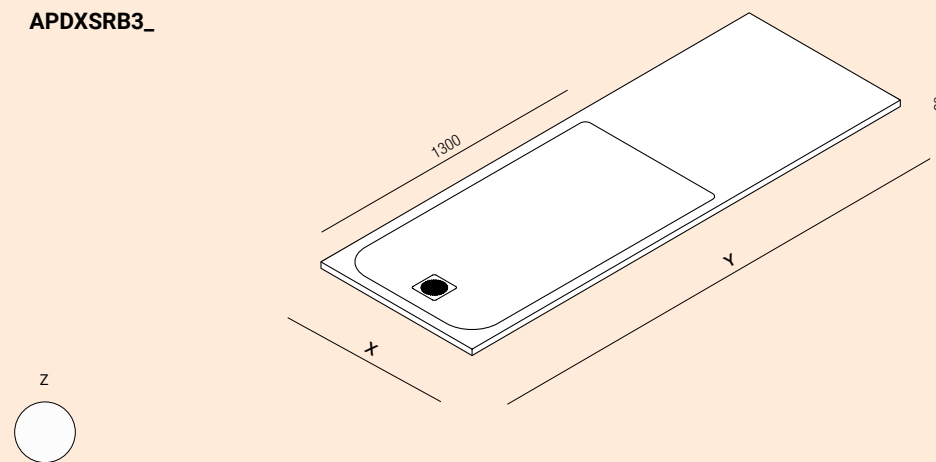

Custom built shower tray in Ceramilux® with rectangular basin / Piatto doccia in Ceramilux® a misura con invaso rettangolare

X 700 – 900 mm
Y 1400 – 2400 mm

APDXSTB3_

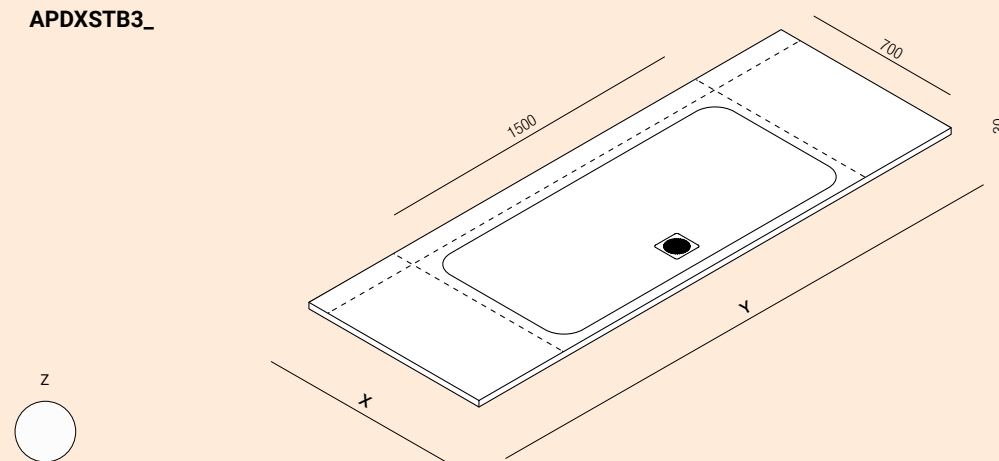

Custom built shower tray in Ceramilux® with central drain and rectangular basin / Piatto doccia in Ceramilux® a misura con scarico centrale e invaso rettangolare

X 800 – 900 mm
Y 1600 – 2400 mm

APDX_UB4

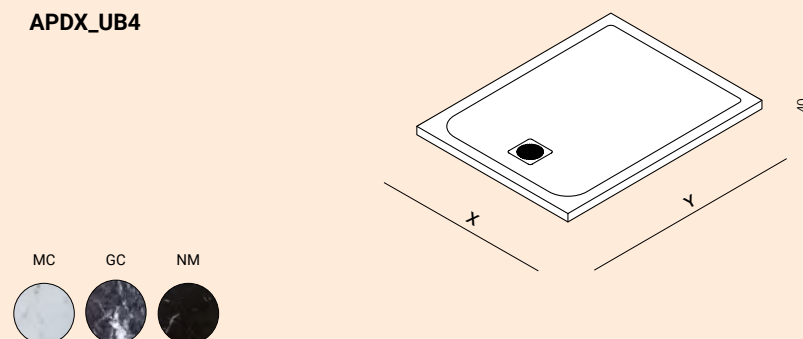

Shower tray in marble with standard dimensions / Piatto doccia in marmo con misure standard

X 800 – 1000 mm
Y 900 – 1600 mm



Amuleto

Shower tray / Piatto doccia

Amuleto is a statement, an object that comes from elsewhere. Amuleto declares the apparent simplicity of his geometry but on closer inspection, it let's you discover its fine details and its delicate curves. Its ample, almost irreverent radius accentuates its two-dimensionality while the Petit Granit opens up unexpected depths in which to lose the gaze. With his absolute gesture, Amuleto transcends the scale of the object for an intense dialogue with the space that embraces it. Both inside and outside.

Amuleto is a round shower tray made of Petit Granit marble. The product includes the waste trap with a chromed ABS drain cover plate.

Amuleto è un gesto plateale, un oggetto arrivato da altrove. Amuleto enuncia l'apparente semplicità della sua geometria ma all'avvicinarsi, lascia lo spazio alla scoperta di dettagli fini e di sezioni dalle curve delicate. Il suo ampio, quasi irriverente raggio accentua la sua bidimensionalità mentre il Petit Granit schiude inaspettate profondità in cui perdere lo sguardo. Con il suo gesto assoluto, Amuleto trascende la scala dell'oggetto per un dialogo intenso con lo spazio che lo accoglie sia all'interno che all'esterno.

Amuleto è un piatto doccia tondo realizzato in marmo Petit Granit. È compreso di sifone con piastra di copertura dello scarico in ABS cromato.

☀️ ADOC1300PG

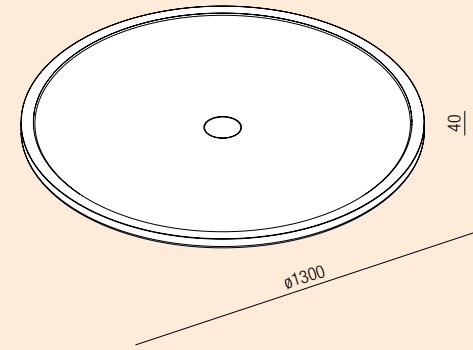

design Benedini Associati, 2019



Amuleto

Shower tray / Piatto doccia

Amuleto – shower tray / piatto doccia
Open air – taps / rubinetteria
Mach 2 – shelf / mensola



Petra

Column and shower tray / Colonna e piatto doccia

Column and shower base, the latter can also be used detached from the column, realized in Cementoskin® with natural and velvety surface available in different colors. The shower tray evokes the shape of the homonym washbasin.

Colonna e piatto doccia, quest'ultimo utilizzabile anche svincolato dalla colonna, realizzati in Cementoskin® con superficie naturale e vellutata disponibile in diverse colorazioni. Il piatto doccia ricalca la sagoma del lavabo omonimo.

☀️ ACER098_

☀️ APTR0810_

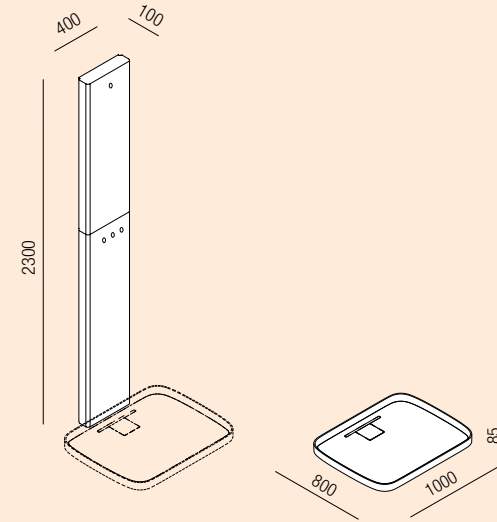

design Diego Vencato, Marco Merendi, 2018



180

110

540

570

730



Petra

Column and shower tray / Colonna e piatto doccia



Petra – shower tray / piatto doccia
 Petra – column / colonna
 Square – taps / rubinetteria
 Kaa – shower head and handheld shower / soffione e doccia

Petra

Slatted shower tray / Pedana per doccia

Slatted shower tray in Cementoskin® available in different colours with support frame in black brushed anodized aluminum. The shower tray is composed by slats collected by a perimetric stainless steel profile complete with anchorages for the floor fixing.

Pedana per doccia con doghe in Cementoskin® disponibile in diverse colorazioni, con telaio di sostegno in alluminio anodizzato spazzolato nero. La pedana è composta da doghe raccolte da un profilo perimetrale in acciaio inox completo di ancoraggi per il fissaggio al suolo.

- ☀️ **APTRD0808_** L 779
- ☀️ **APTRD0810_** L 975
- ☀️ **APTRD0812_** L 1171
- ☀️ **APTRD0814_** L 1367

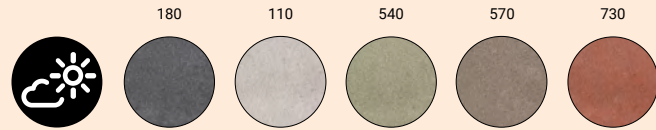
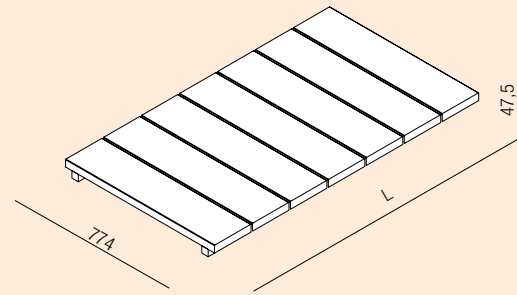

design Diego Vencato, Marco Merendi, 2018



Petra

Slatted shower tray / Pedana per doccia

Petra – slatted shower tray / pedana per doccia
Handwash – washbasin / lavabo
Square – taps / rubinetteria
Fusilli – mirror / specchio



Cooper

Showers / Docce

A stainless steel rail suspended from the ceiling using a special support, and a sliding curtain, together create an intimate, ethereal atmosphere: this is the simple yet infinitely versatile concept of Cooper.

Its flexibility enables Cooper to create any configuration: an open or closed ring, large or small, making the best use of the available space and personalising the room in which it is installed.

Un nastro di acciaio inox, appeso al soffitto con appositi supporti e una tenda scorrevole creano un'atmosfera intima e leggera: questo è il concetto semplice, ma allo stesso tempo infinitamente versatile, di Cooper.

Grazie alla sua flessibilità, Cooper consente di creare qualsiasi configurazione, ad anello oppure aperta, grande o piccola, utilizzando al meglio lo spazio disponibile e personalizzando l'ambiente in cui è collocato.

Closed configurations / Configurazioni chiuse

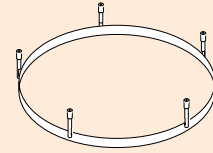

Open configurations / Configurazioni aperte

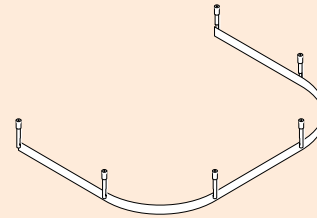

design RD Agape, 2007

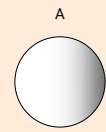

Cooper

Showers / Docce



Cooper – shower tray / doccia
 Vieques – bathtub / vasca
 Fez 2 – taps / rubinetteria
 4x4 – mirror cabinets / specchi contenitori

Cooper

Coded configurations / Configurazioni codificate

Closed configurations / Configurazioni chiuse

ADOC0361C

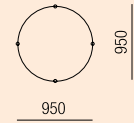

ADOC0362C

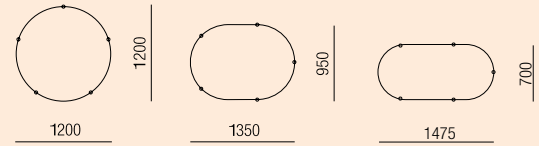

ADOC0371C

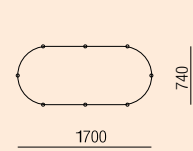

ADOC0363C

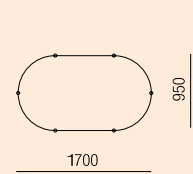

ADOC0364C

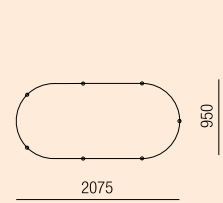

ADOC0365C

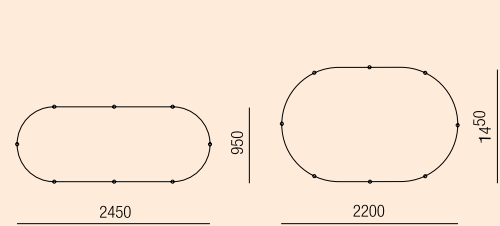

Open configurations / Configurazioni aperte

ADOC0359A

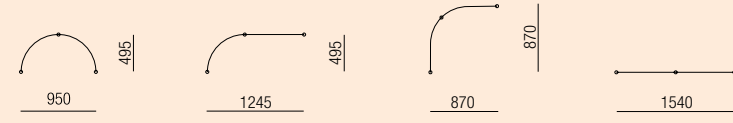

ADOC0360A

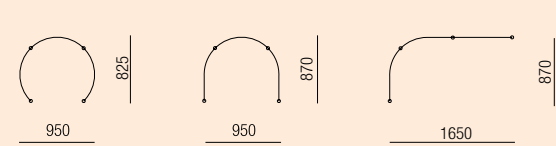

ADOC0361A

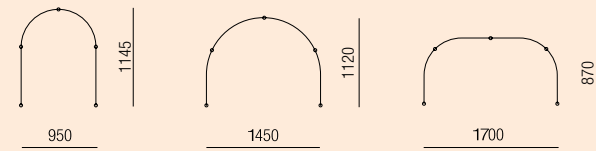

ADOC0362A

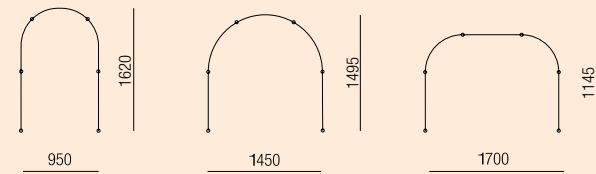

ADOC0363A

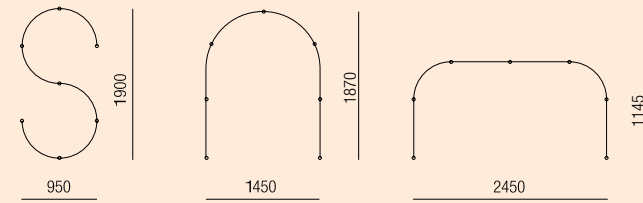

ADOC0364A

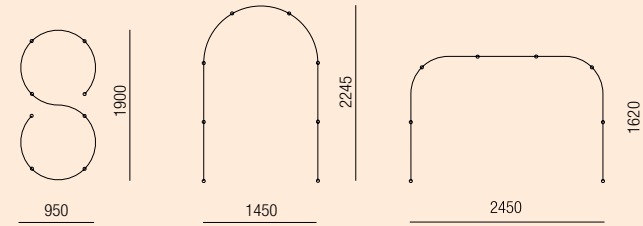

ADOC0365A

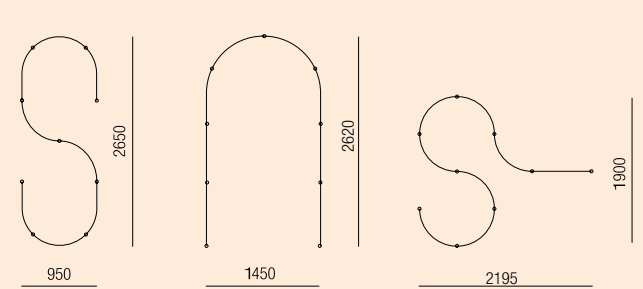

Cooper

Showers / Docce



Accessories / Accessori

Alongside the key fixtures in the bathroom, Agape accessories have an important supporting role: to make life simpler and more pleasant with their style and functionality.

Accanto ai protagonisti dell'ambiente bagno, anche gli accessori Agape hanno un ruolo importante: rendere la vita più bella e più comoda, grazie al loro stile ed alla loro funzionalità.

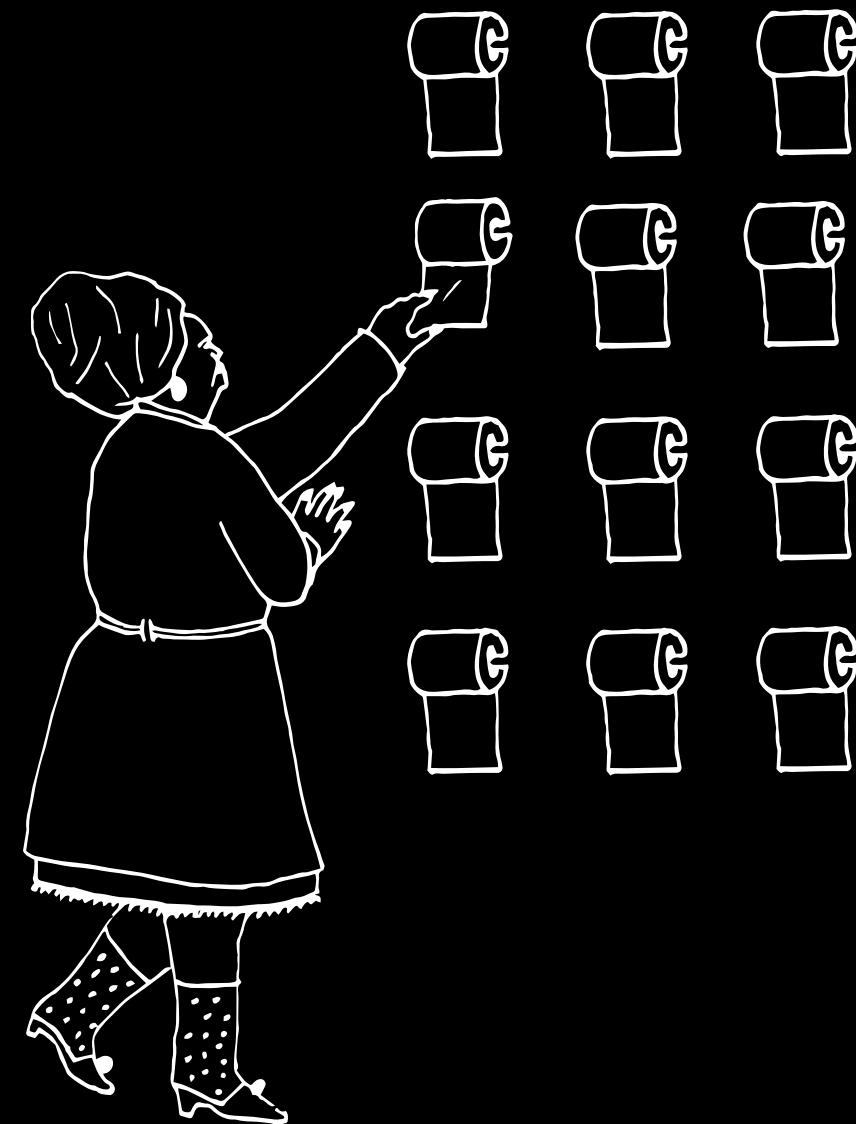

		soap holders / porta sapone	dispensers / dispenser	toothbrush holder / porta spazzolini	shelves / mensole	clothes hangers / porta abiti	towel holders / porta salviette
369	p. 202	●	☀	●	☀	☀	☀
Bucatini	p. 210	●	●	●	●	●	●
Dot Line	p. 216	●		●	●	●	●
Mach 2	p. 222	☀	☀	●	☀	☀	☀
Memory	p. 230	●		●	●	●	●
Sen	p. 236	●	●	●	●	●	●

Finishes accessories / Finiture accessori

	A	SP	Z	E	N	BR	NR
369	●	●					
Bucatini	●	●	●	●			
Dot Line					●		
Mach 2	●	●		●			
Memory	●		●*	●		●	●
Sen					●		

* On demand / A richiesta

		sanitary bags dispenser / porta sacchetti igienici	wastepaper baskets / gettacarta	toilet roll holders / porta rotolo	toilet brush holders / porta scopino	heated towel racks / scalda salviette
369	p. 202		☀	●	●	
Bucatini	p. 210			●	●	
Dot Line	p. 216			●	●	
Mach 2	p. 222	●	☀	●	●	
Memory	p. 230			●	●	●
Sen	p. 236			●	●	●

Finishes accessories / Finiture accessori

	RT	RW	RW	CU	GM	NL
369						
Bucatini						
Dot Line	●	●	●			
Mach 2						
Memory				●*	●*	●*
Sen						



Items marked with this symbol are part of the Outdoor Collection and can also be used outdoors / Gli articoli contrassegnati con questo simbolo fanno parte della Collezione Outdoor e possono essere utilizzati anche all'esterno

369

Accessories / Accessori

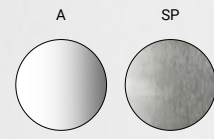

Range of accessories in a rigorously contemporary style. Support elements in stainless steel AISI 304 with satin or polished finish, and elements in white Cristalplant®.

Programma di accessori con uno stile rigorosamente contemporaneo. Supporti realizzati in acciaio inox AISI 304 satinato o lucido, ed elementi in Cristalplant® bianco.

design Benedini Associati, 2004

**369**

Accessories / Accessori



369

Accessories / Accessori



369

Accessories / Accessori



369

Accessories / Accessori



369

Accessories / Accessori

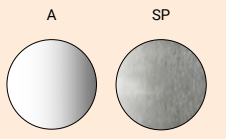

A369231_

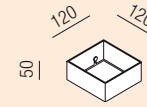

Stainless steel shelf, 12 cm /
Mensola in acciaio inox, cm 12

A369232_

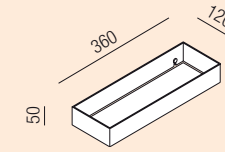

Stainless steel shelf, 36 cm /
Mensola in acciaio inox, cm 36

A369233_

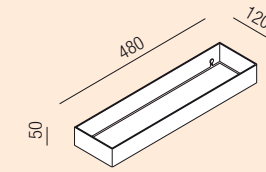

Stainless steel shelf, 48 cm /
PMensola in acciaio inox, cm 48

A369234_

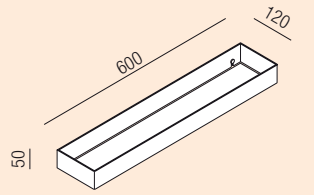

Stainless steel shelf, 60 cm /
Mensola in acciaio inox, cm 60

A369222_

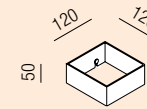

Stainless steel towel holder
with add ons, 12 cm / Porta
salviette accessoriabile in
acciaio inox, cm 12

A369200_

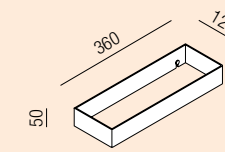

Stainless steel towel holder
with add ons, 36 cm / Porta
salviette accessoriabile in
acciaio inox, cm 36

A369201_

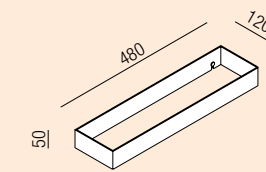

Stainless steel towel holder
with add ons, 48 cm / Porta
salviette accessoriabile in
acciaio inox, cm 48

A369202_

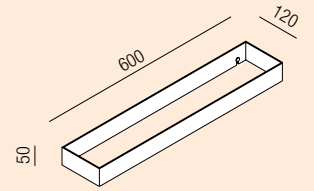

Stainless steel towel holder
with add ons, 60 cm / Porta
salviette accessoriabile in
acciaio inox, cm 60

A369204_

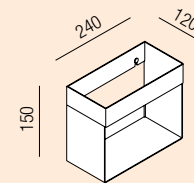

Stainless steel shelf with add
ons with shelf, 24 cm / Mensola
accessoriabile in acciaio inox
con ripiano, cm 24

A369205_

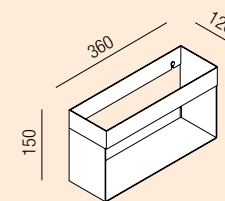

Stainless steel shelf with add
ons with shelf, 36 cm / Mensola
accessoriabile in acciaio inox
con ripiano, cm 36

A369206_

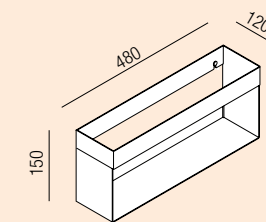

Stainless steel shelf with add
ons with shelf, 48 cm / Mensola
accessoriabile in acciaio inox
con ripiano, cm 48

A369207_

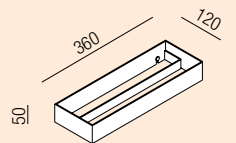

Twin stainless steel towel holder,
36 cm / Porta salviette doppio in
acciaio inox, cm 36

369

Accessories / Accessori

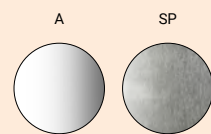

A369208_

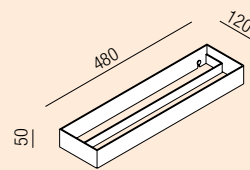

Twin stainless steel towel holder, 48 cm / Porta salviette doppio in acciaio inox, cm 48

A369209_

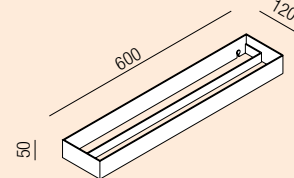

Twin stainless steel towel holder, 60 cm / Porta salviette doppio in acciaio inox, cm 60

A369210Z

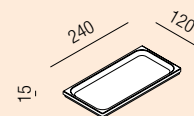

Cristalplant® shelf, to be placed on the upper part of the support elements / Mensola in Cristalplant® da inserire sulla parte superiore degli elementi accessoriabili

A369211Z

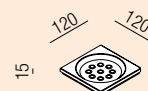

Cristalplant® soap dish, to be placed on the upper part of the support elements / Porta sapone in Cristalplant® da inserire sulla parte superiore degli elementi accessoriabili

A369228Z

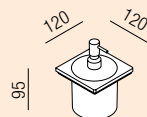

Cristalplant® liquid soap dispenser, to be placed on the upper part of the support elements / Dispenser per sapone liquido in Cristalplant®, da inserire sulla parte superiore degli elementi accessoriabili

A369213_

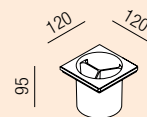

Cristalplant® toothbrush holder, to be placed in the upper part of the support elements / Porta spazzolini in Cristalplant® bianco da inserire nella parte superiore degli elementi accessoriabili

A369224_

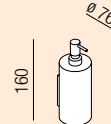

Wall mounted dispenser for liquid soap / Dispenser a parete per sapone liquido

A369223_

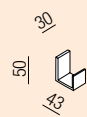

Stainless steel clothes hanger / Porta abiti in acciaio inox

A369215_Z

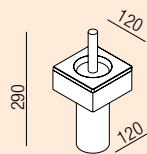

Stainless steel toilet brush holder / Porta scopino in acciaio inox

A369217_

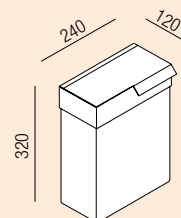

Waste paper basket in stainless steel / Gettacarta in acciaio inox

A369219_

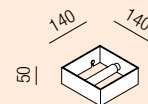

Stainless steel toilet roll holder (roll ø 125 mm) / Porta rotolo in acciaio inox (rotolo max ø 125 mm)

369

Accessories / Accessori

Cristalplant® shelf, to be placed on the upper part of the support elements / Mensola in Cristalplant® da inserire sulla parte superiore degli elementi accessoriabili

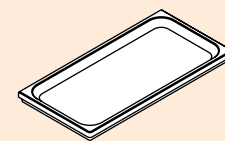

Cristalplant® toothbrush holder, to be placed in the upper part of the support elements / Porta spazzolini in Cristalplant® bianco da inserire nella parte superiore degli elementi accessoriabili

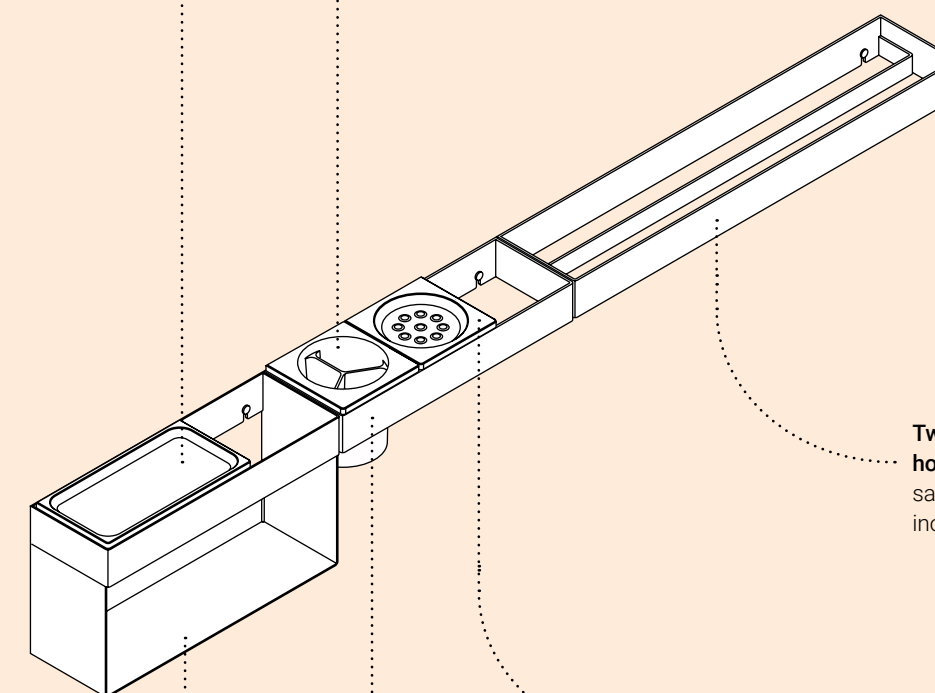
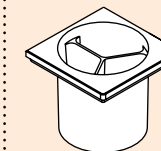

Twin stainless steel towel holder, 60 cm / Porta salviette doppio in acciaio inox, cm 60

Cristalplant® soap dish, to be placed on the upper part of the support elements / Porta sapone in Cristalplant® da inserire sulla parte superiore degli elementi accessoriabili



Stainless steel shelf with add ons with shelf, 36 cm / Mensola accessoriabile in acciaio inox con ripiano, cm 36

Stainless steel towel holder with add ons, 36 cm / Porta salviette accessoriabile in acciaio inox, cm 36

Bucatini

Accessories / Accessori

A complete range of accessories for furnishing the bathroom with a non-conventional style, made from stainless steel cable sheathed in plastic, also used as supports for ceramic containers. Stainless steel fixings in polished inox, satin finished inox, matt white, matt black.

Programma di accessori completo per arredare il bagno con uno stile anticonvenzionale, realizzati con un cavetto in acciaio inox ricoperto da materiale plastico che ha anche funzione di supporto per contenitori in ceramica. Fissaggi in acciaio inox lucido, spazzolato, bianco opaco e nero opaco.

design Fabio Bortolani, Ermanno Righi, 1997



Fixing finish / Finitura fissaggi



Cable finish / Finitura cavetto

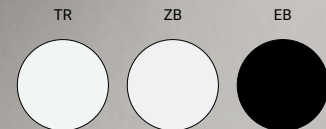

Ceramic finish / Finitura ceramica



Bucatini

Accessories / Accessori



Bucatini

Accessories / Accessori



Bucatini

Accessories / Accessori



Bucatini

Accessories / Accessori

ABUC0160_

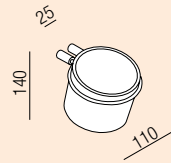

Wall mounted ceramic soap holder / Porta sapone in ceramica a parete

ABUC0160S_

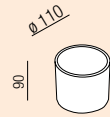

Countertop ceramic soap holder / Porta sapone in ceramica, da appoggio

ABUC0161_

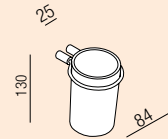

Wall mounted ceramic toothbrush holder / Porta spazzolini in ceramica a parete

ABUC0161S_

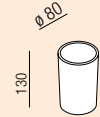

Countertop ceramic toothbrush holder / Porta spazzolini in ceramica, da appoggio

ABUC0179_



Dispenser support / Supporto per dispenser

ABUC0165_

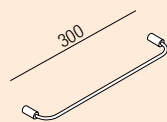

Towel holder, 30 cm / Porta salviette, cm 30

ABUC0166_

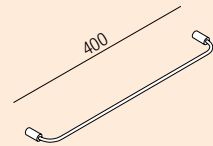

Towel holder, 40 cm / Porta salviette, cm 40

ABUC0167_

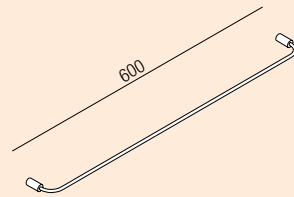

Towel holder, 60 cm / Porta salviette, cm 60

ABUC0168_

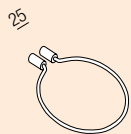

Ring towel holder / Porta salviette ad anello

ABUC0169_

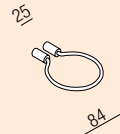

Towel holder / Porta salviette

ABUC0171_

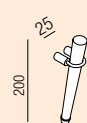

Clothes hanger / Porta abiti

ABUC0172_

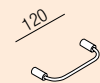

Toilet roll holder / Porta rotolo

Bucatini

Accessories / Accessori

ABUC0173_

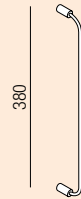

Multiple toilet holder / Porta rotolo multiplo

ABUC0175_

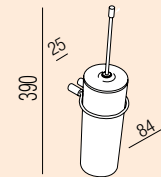

Toilet brush holder / Porta scopino

ABUC0176_

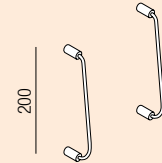

Magazine holder / Porta riviste

Fixing finish / Finitura fissaggi



Ceramic finish / Finitura ceramica

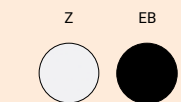

Cable finish / Finitura cavetto

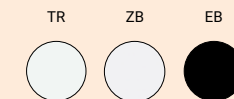

Discover the Bucatini collection mirrors at page 339 / Scopri gli specchi della collezione Bucatini a pagina 339

Dot Line

Accessories / Accessori



Accessories made of tubular bar in aluminium consisting of brackets (dot) supporting a bar (line) with brushed black anodized finish or with natural, brown or dark oak veneer. In addition to each single item it is possible to obtain a continuous bar that performs the various functions. Both the individual items and the continuous bar can be fitted with shelves, hooks or glasses in aluminium freely positionable along its entire length.

Accessori realizzati con tubolare in alluminio formati da supporti (dot) che sorreggono una barra (line) con finitura anodizzata spazzolata nera o con rivestimento in rovere naturale, bruno o scuro. Oltre agli articoli singoli è possibile avere una barra continua che svolge le varie funzioni. Sia gli articoli singoli che la barra continua possono essere accessoriati con mensole, ganci o bicchieri in alluminio posizionabili liberamente su tutta la lunghezza.

design García Cumini, 2016

Selected "AZ AWARDS" 2017



Dot Line

Accessories / Accessori



Dot Line

Accessories / Accessori



Dot Line

Accessories / Accessori



Dot Line

Accessories / Accessori



ADTL0458_



Clothes hanger / Porta abiti

ADTL0452_



Toilet roll holder / Porta rotolo

ADTL0453_

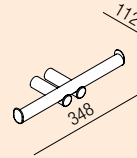

Double toilet roll holder / Porta rotolo doppio

ADTL0454_

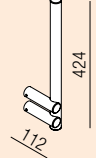

Spare toilet roll holder / Porta rotoli per scorta

ADTL0457_

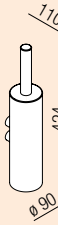

Wall mounted toilet brush holder / Porta scopino a parete

ADTL0000_

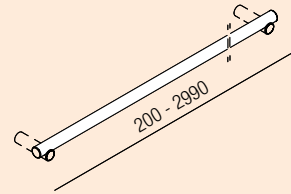
Customized bar, \varnothing 30 mm line, length from 200 mm to 2990 mm / Barra su misura \varnothing mm 30, lunghezza da mm 200 a mm 2990

ADTL0470N



Black aluminium wall support / Supporto a parete in alluminio nero

ADTL0469N



Closing element for bars with black finish / Elemento di chiusura per barre con finitura nera

ADTL0469



Closing element for bars with oak finish / Elemento di chiusura per barre con finitura rovere

ADTL0468N



Closing element with hook, for all finishes / Elemento di chiusura con gancio, per tutte le finiture

ADTL0467N



Aluminium hook / Gancio in alluminio

ADTL0466

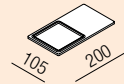

Shelf with soap dish in aluminium / Mensola con porta sapone in alluminio

Dot Line

Accessories / Accessori



ADTL0471

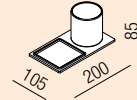

Shelf with soap dish and glass in aluminium / Mensola con porta sapone e bicchiere in alluminio

ADTL0465

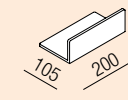

Shelf for shower in aluminium / Mensola per doccia in alluminio

Discover the Dot Line collection mirrors at page 341 and the extras at page 254 / Scopri gli specchi della collezione Dot Line a pagina 341 e i complementi a pagina 254

ADTL0457_

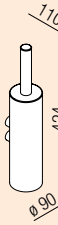

Wall mounted toilet brush holder / Porta scopino a parete

ADTL0000_

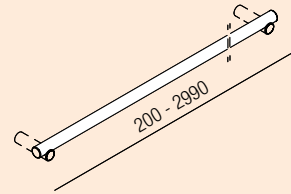
Customized bar, \varnothing 30 mm line, length from 200 mm to 2990 mm / Barra su misura \varnothing mm 30, lunghezza da mm 200 a mm 2990

ADTL0470N



Black aluminium wall support / Supporto a parete in alluminio nero

ADTL0469N



Closing element for bars with black finish / Elemento di chiusura per barre con finitura nera

ADTL0469



Closing element for bars with oak finish / Elemento di chiusura per barre con finitura rovere

ADTL0468N



Closing element with hook, for all finishes / Elemento di chiusura con gancio, per tutte le finiture

ADTL0467N



Aluminium hook / Gancio in alluminio

ADTL0466

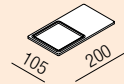

Shelf with soap dish in aluminium / Mensola con porta sapone in alluminio

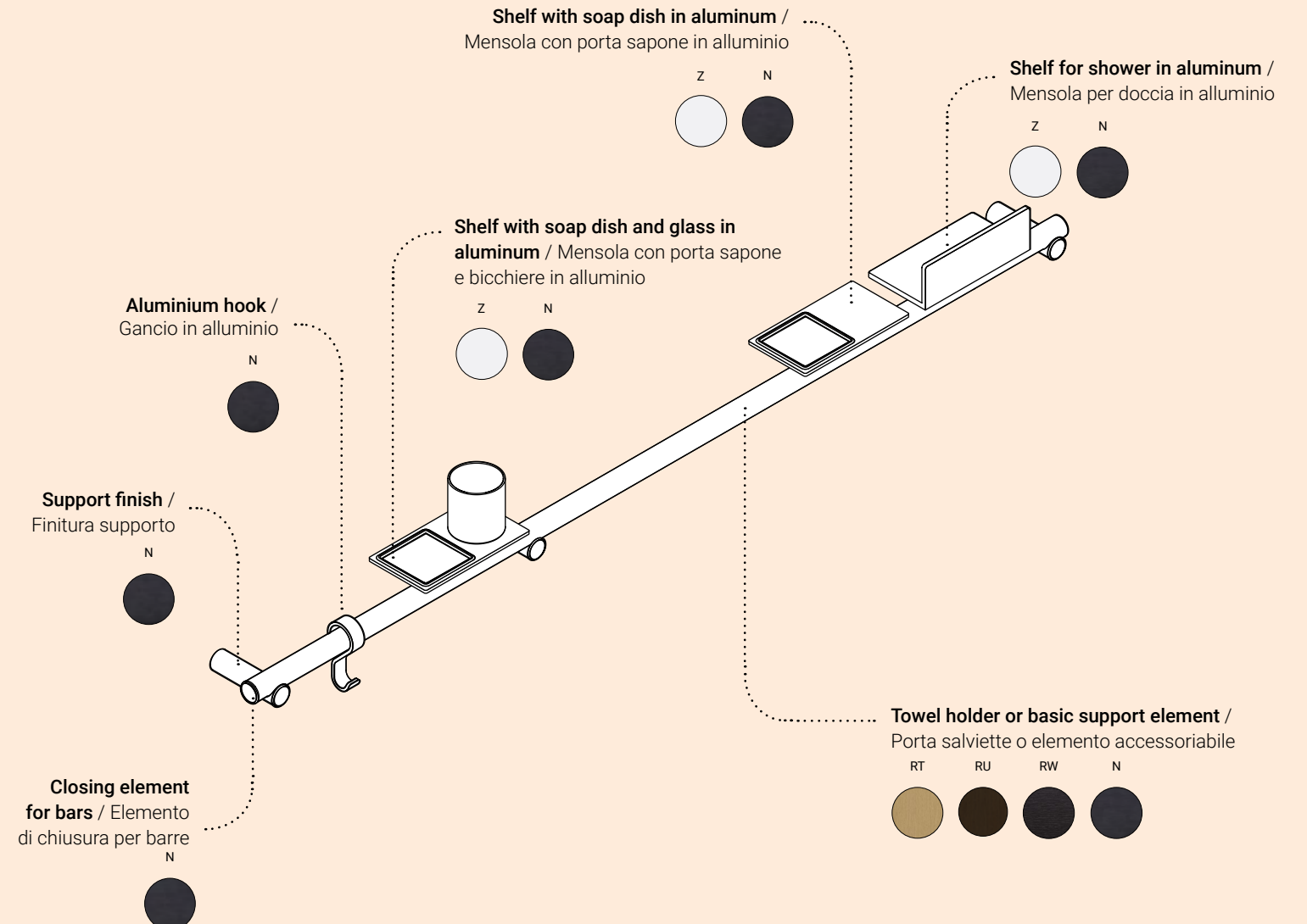

Mach 2

Accessories / Accessori



Mach 2 takes a look at the original Mach series from a fresh perspective. The new project is the result of a detailed analysis of all the elements in the original collection based on user experience and feedback. The programme, with a bold technical look, is made of polished or satin-finish stainless steel AISI 304 with polished edges, or coated in matt black, making it suitable also for outdoor spaces. In keeping with the professional spirit of the original collection, Mach 2 introduces a series of practical new elements which comply with the stringent requirements for use in public spaces, but also make this product family extremely versatile and suitable for the most exclusive domestic bathrooms.

Mach 2 rivisita la serie Mach originale da una nuova prospettiva. Il nuovo progetto è il risultato di un'analisi dettagliata di ogni elemento della collezione originale in funzione dell'esperienza e dell'utilizzo da parte degli utenti. Il programma, dall'estetica sincera e dal segno tecnico, è realizzato in acciaio inox AISI 304 lucido, satinato con bordi lucidi, oppure verniciato in nero opaco, rendendolo adatto anche per l'utilizzo in ambienti esterni. In linea con lo spirito professionale della collezione originale, Mach 2 introduce una serie di nuovi elementi funzionali che, pur rispettando gli stringenti requisiti derivanti dall'utilizzo in ambienti pubblici, rendono questa famiglia di prodotti estremamente versatile e adatta anche agli ambienti domestici più esclusivi.

design Konstantin Grcic, 2019



agape

Mach 2

Accessories / Accessori



agape

Mach 2

Accessories / Accessori



Mach 2

Accessories / Accessori



Mach 2

Accessories / Accessori



Mach 2

Accessories / Accessori



Mach 2

Accessories / Accessori



AMC20920_

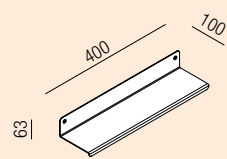

☼
Single stainless steel shelf, 40 cm / Mensola singola in acciaio inox, cm 40

AMC20921_

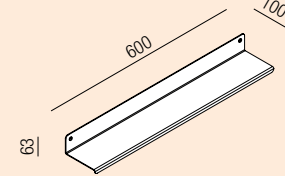

☼
Single stainless steel shelf, 60 cm / Mensola singola in acciaio inox, cm 60

AMC20922_

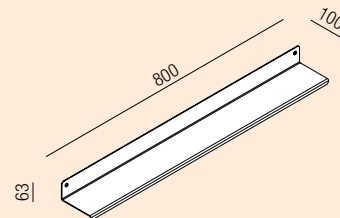

☼
Single stainless steel shelf, 80 cm / Mensola singola in acciaio inox, cm 80

AMC20923_

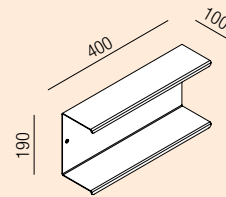

☼
Double stainless steel shelf, 40 cm / Mensola doppia in acciaio inox, cm 40

AMC20924_

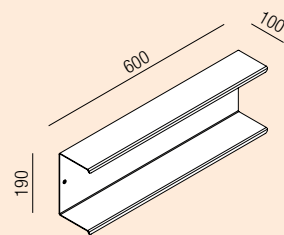

☼
Double stainless steel shelf, 60 cm / Mensola doppia in acciaio inox, cm 60

AMC20925_

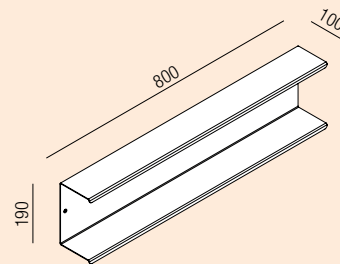

☼
Double stainless steel shelf, 80 cm / Mensola doppia in acciaio inox, cm 80

AMC20926_

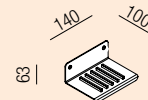

☼
Stainless steel soap holder / Porta sapone in acciaio inox

AMC20927_

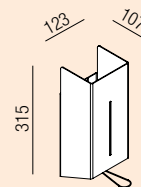

☼
Stainless steel liquid soap dispenser / Dispenser per sapone liquido in acciaio inox

AMC20928_

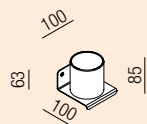

☼
Stainless steel toothbrush holder / Porta spazzolini in acciaio inox

AMC20929_

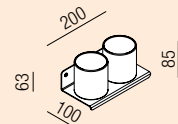

☼
Double stainless steel toothbrush holder / Porta spazzolini doppio in acciaio inox

AMC20930_

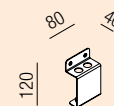

☼
Stainless steel toothbrush holder / Porta spazzolini in acciaio inox

AMC20931_

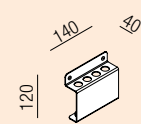

☼
Stainless steel toothbrush holder / Porta spazzolini in acciaio inox

Mach 2

Accessories / Accessori

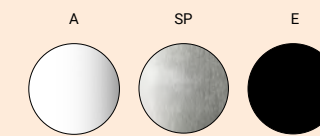

AMC20932_

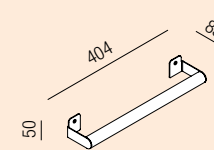

☼
Stainless steel towel holder, 40,4 cm / Porta salviette in acciaio inox, 40,4 cm

AMC20933_

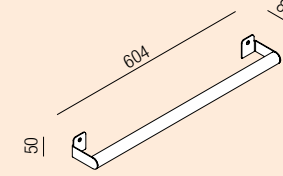

☼
Stainless steel towel holder, 60,4 cm / Porta salviette in acciaio inox, 60,4 cm

AMC20934_

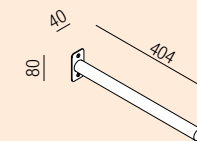

☼
Stainless steel flag towel holder, 40,4 cm / Porta salviette a bandiera in acciaio inox, 40,4 cm

AMC20935_

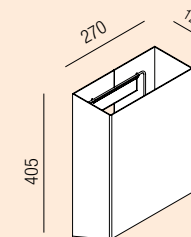

☼
Stainless steel paper towel dispenser / Dispenser salviette in acciaio inox

AMC20936_

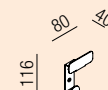

☼
Stainless steel clothes hanger / Porta abiti in acciaio inox

AMC20937_

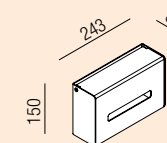

☼
Stainless steel tissue box holder / Porta "kleenex" in acciaio inox

AMC20938_

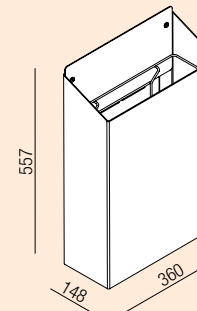

☼
Stainless steel wastepaper basket / Gettacarta in acciaio inox

AMC20939_

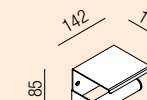

☼
Stainless steel toilet roll holder / Porta rotolo in acciaio inox

AMC20940_

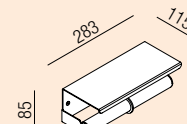

☼
Double stainless steel toilet roll holder / Porta rotolo doppio in acciaio inox

AMC20941_

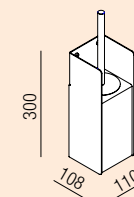

☼
Stainless steel toilet brush holder / Porta scopino in acciaio inox

AMC20942_

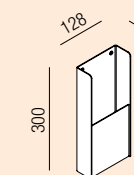

☼
Stainless steel sanitary bags dispenser / Porta sacchetti igienici in acciaio inox

Memory

Accessories / Accessori

A complete range of accessories for the bathroom born in 2010, constantly enriched with new proposals, inspired by the culture of 20th century design with deep aesthetic and cultural roots, revisited in a contemporary light.

Una proposta completa di accessori per la sala da bagno nata nel 2010, costantemente arricchita di nuove proposte, ispirata alla cultura del design del XX secolo con radici estetiche e culturali profonde, rivisitata alla luce della contemporaneità.

design Benedini Associati, 2010



Supports finish / Finitura supporti

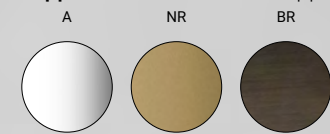

Shelves and containers finish / Finitura mensole e contenitori

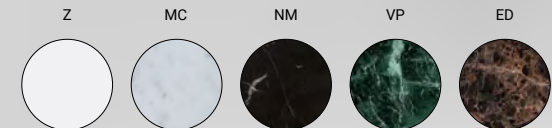

Memory

Accessories / Accessori



Memory

Accessories / Accessori



Memory

Accessories / Accessori



Memory

Accessories / Accessori

AMEM856_

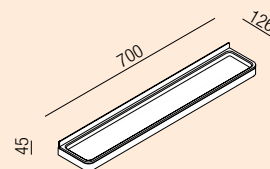

Stainless steel shelf with element in Cristalplant® or marble, cm 60 / Mensola in acciaio inox con ripiano in Cristalplant® o marmo, cm 60

AMEM872_

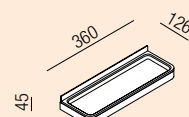

Stainless steel shelf with element in Cristalplant® or marble, 36 cm / Mensola in acciaio inox con ripiano in Cristalplant® o marmo, cm 36

AMEM852_

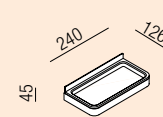

Stainless steel shelf with element in Cristalplant® or marble, 24 cm / Mensola in acciaio inox con ripiano in Cristalplant® o marmo, cm 24

AMEM851_

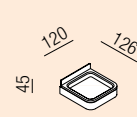

Stainless steel shelf with element in Cristalplant® or marble, cm 12 cm / Mensola o porta sapone in acciaio inox con ripiano in Cristalplant® o marmo, cm 12

AMEM861_

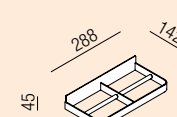

Double stainless steel toilet roll holder / Porta rotolo doppio in acciaio inox

AMEM855_Z

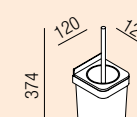

Stainless steel toilet brush holder / Porta scopino in acciaio inox

Discover the Memory collection taps at page 290 and 298, mirrors at page 350, extras at page 258 and heating elements at page 242 / Scopri i rubinetti della collezione Memory a pagina 290 e 298, gli specchi a pagina 350, i complementi a pag 258 e l'elemento riscaldante a pag 242

AMEM854_Z

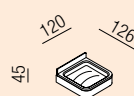

Stainless steel soap holder with dish in Cristalplant® / Porta sapone in acciaio inox con piattello in Cristalplant®

AMEM853_Z

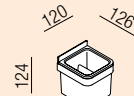

Stainless steel toothbrush holder with tumbler in Cristalplant® / Porta spazzolini in acciaio inox con contenitore in Cristalplant®

AMEM853_

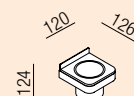

Stainless steel toothbrush holder with dish in marble / Porta spazzolini in acciaio inox con piattello in marmo

AMEM857_

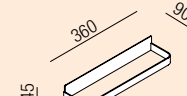

Stainless steel towel holder, 36 cm / Porta salviette in acciaio inox, cm 36

AMEM858_

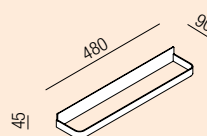

Stainless steel towel holder, 48 cm / Porta salviette in acciaio inox, cm 48

AMEM859_

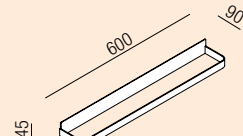

Stainless steel towel holder, 60 cm / Porta salviette in acciaio inox, cm 60

AMEM864_



Stainless steel clothes hanger / Porta abiti in acciaio inox

AMEM860_

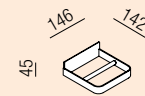

Stainless steel toilet roll holder / Porta rotolo in acciaio inox

Sen

Accessories / Accessori

N

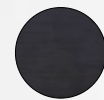

Accessories made from brushed anodised aluminium in black finish, to be matched with the range of taps with the same name. Due to their unique shape, we recommend that all wall-mounted accessories are fixed to a perfectly flat surface.

Accessori realizzati in alluminio anodizzato spazzolato con finitura nera abbinabili all'omonima serie di rubinetti. Data la particolare sagoma degli accessori a parete è consigliabile l'utilizzo su superfici perfettamente piane.

design Gwenael Nicolas, Curiosity, 2008

Selected "ADI DESIGN INDEX" 2009

**Sen**

Accessories / Accessori

N



Sen

Accessories / Accessori

N



ASEN0915N

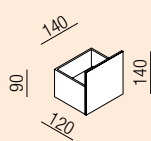

Shelf or single toilet roll holder
/ Mensola porta oggetti o porta rotolo singolo

ASEN0917N

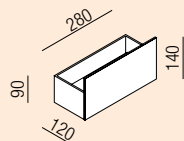

Shelf or double toilet roll holder
/ Mensola porta oggetti o porta rotolo doppio

ASEN0917NS

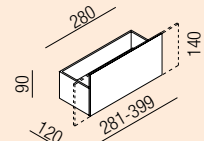

Shelf or double toilet roll holder with front element made-to-measure
/ Mensola porta oggetti o porta rotolo doppio con elemento frontale a misura

ASEN0921N

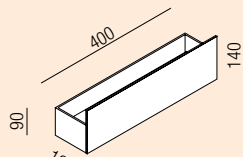

Shelf, 40 cm / Mensola porta oggetti, 40 cm

ASEN0921NS

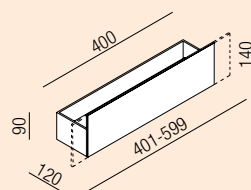

Shelf with front element made-to-measure
/ Mensola porta oggetti con elemento frontale a misura

ASEN0927N

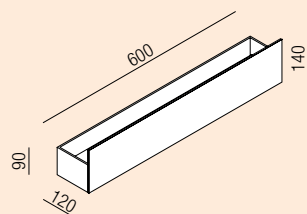

Shelf, 60 cm / Mensola porta oggetti, 60 cm

ASEN0927NS

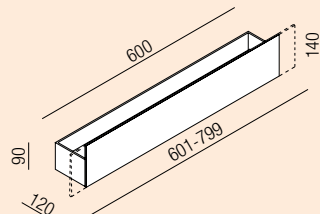

Shelf with front element made-to-measure
/ Mensola porta oggetti con elemento frontale a misura

ASEN0923N

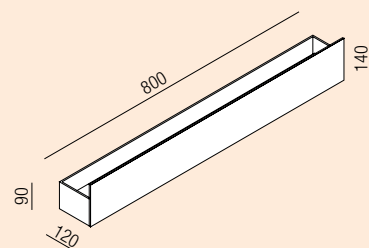

Shelf, 80 cm / Mensola porta oggetti, 80 cm

ASEN0933N

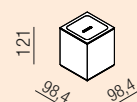

Countertop soap holder / Porta sapone d'appoggio

ASEN0934N

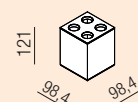

Countertop toothbrush holder
/ Porta spazzolini d'appoggio

ASEN0931N

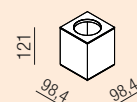

Toothpaste holder
/ Porta dentifricio

ASEN0924N

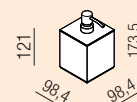

Liquid soap dispenser (50 cl) with spout in plastic material
/ Dispenser per sapone liquido d'appoggio (50 cl) con erogatore in materiale plastico

Sen

Accessories / Accessori

N



ASEN0930N



Aluminum hook; it is fixed by interlocking on the underside of the shelves of the series
/ Gancio in alluminio; si fissa ad incastro sul lato inferiore delle mensole della serie

ASEN0919N

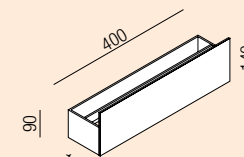

Towel holder, 40 cm / Porta salviette, 40 cm

ASEN0919NS

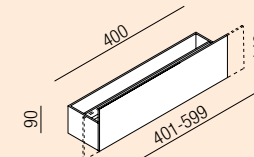

Towel holder with front element made-to-measure
/ Porta salviette con elemento frontale a misura

ASEN0928N

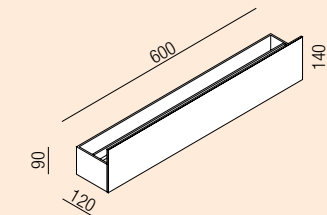

Towel holder, 60 cm / Porta salviette, 60 cm

ASEN0928NS

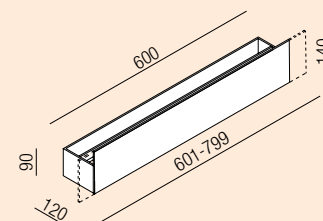

Towel holder with front element made-to-measure
/ Porta salviette con elemento frontale a misura

ASEN0922N

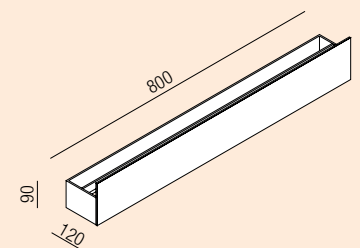

Towel holder, 80 cm / Porta salviette, 80 cm

ASEN0974N



Clothes hanger / Porta abiti

ASEN0972N

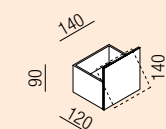

Toilet roll holder
/ Porta rotolo singolo

ASEN0925NN

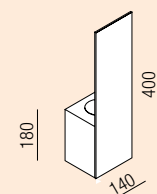

Toilet brush holder
/ Porta scopino

Discover the Sen collection taps at page 304 and heating elements at page 243 / Scopri i rubinetti della collezione Sen a pagina 304 e l'elemento riscaldante a pag 243

Sen

Accessories / Accessori

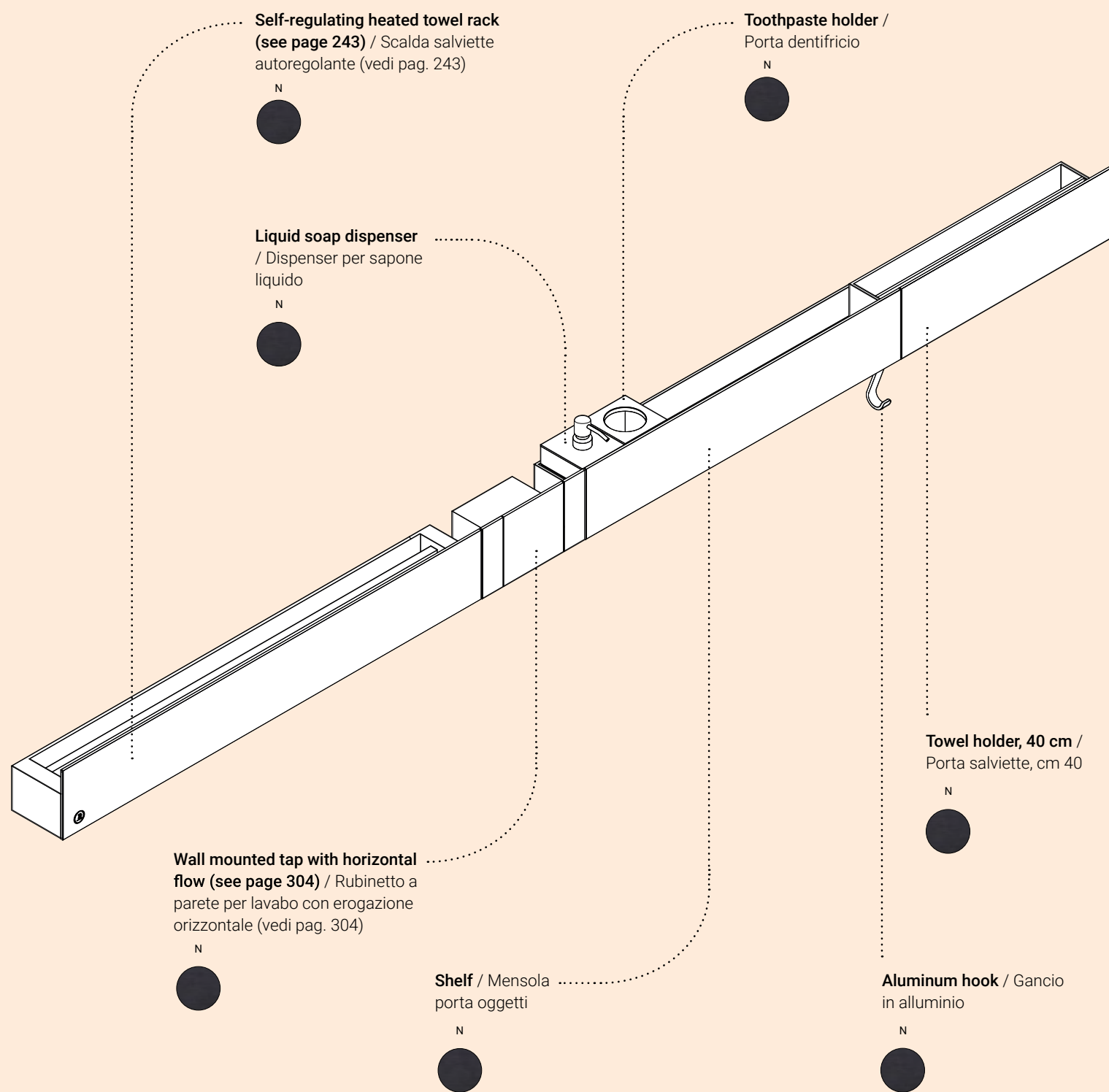
**Heating elements / Elementi riscaldanti**

The warmth of a body. The warmth of a hug in the naked intimacy of the bathroom. Probably there is no other space in the domestic landscape where having the right temperature becomes such an important component of the overall experience. Our range of heating elements offers timeless and iconic solutions perfectly at their ease in the most different contexts thanks to their versatility and modularity.

Il calore del corpo. Il calore di un abbraccio nella nuda intimità della sala da bagno. Probabilmente non non ci sono altri spazi nell'universo domestico dove la temperatura sia una componente così fondamentale dell'esperienza. La nostra gamma di elementi riscaldanti offre soluzioni iconiche e senza tempo che sono perfettamente al loro agio nei contesti più diversi, grazie alla loro versatilità e modularità.



Memory

Heated towel rack / Scalda salviette

A self-regulating, heated towel rack made in stainless steel that inherits its timeless delicate lines from the other elements of the Memory collection to which it belongs. Available in polished chrome finish or painted white or black, it can be freely positioned leaning against the wall. The item requires a 230 V AC power outlet and it is not available for the US market.

Scalda salviette autoregolante realizzato in acciaio inox che eredita le sue delicate linee fuori dal tempo dalla collezione Memory a cui appartiene. Disponibile in versione cromata oppure verniciata bianco o nero, l'elemento può essere posizionato liberamente in appoggio alla parete. L'articolo richiede una presa da 230 V AC e non è disponibile per il mercato USA.

AMEM871_

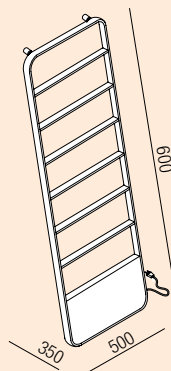

TECHNICAL DATA

300W (painted) - 230V
250W (chromed) - 230V
IP 66 cl 2
Maximum temperature 55/60°

DATI TECNICI

300W (laccato) - 230V
250W (cromato) - 230V
IP 66 cl 2
Temperatura max 55/60°

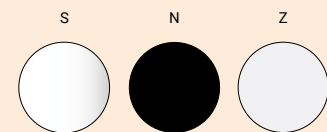

design Benedini Associati, 2010



Sen

Heated towel rack / Scalda salviette

Self-regulating, heated towel rack. This item is modular to the other components of the Sen accessory and taps family and features the same range of finishes. The rack is available in 3 different lengths (80, 100 and 120 cm) and requires a 230 V AC power outlet. The item is not available for the US market.

Scalda salviette autoregolante. Questo elemento è modulare agli altri articoli della famiglia di accessori e rubinetti Sen ed è disponibile nella stessa gamma di finiture. Lo scalda salviette è disponibile in tre diverse lunghezze (80, 100 e 120 cm) e richiede una presa da 230 V AC. L'articolo non è disponibile per il mercato USA.

ASEN0976N – L cm 80
ASEN0978N – L cm 100
ASEN0980N – L cm 120

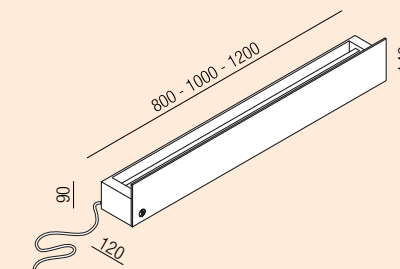

TECHNICAL DATA

250W - 230V
IP 66 cl 2
Maximum temperature 55/60°

DATI TECNICI

250W - 230V
IP 66 cl 2
Temperatura max 55/60°



design Gwenael Nicolas, Curiosity, 2008



Extras / Complementi



Fun and functional ideas, surprising and convenient, capable of going beyond the usual conventions and expressing an advanced concept of bathroom design: all this is Agape, in both large and small solutions.

Idee divertenti e funzionali, sorprendenti e comode, capaci di andare oltre le solite convenzioni e di esprimere un concetto evoluto di stanza da bagno: tutto questo è Agape, nelle grandi come nelle piccole soluzioni.



floor standing /
da appoggio

wall mounted /
a parete

Ascension	p. 247 	
Basket	p. 249	
Cavalletto	p. 250	
Constellation	p. 252	
Dot line	p. 254	
Gemma	p. 256	
Memory	p. 258	
Midi basket	p. 249	p. 249
Multifunzione	p. 260	
Petra		p.261 
Pic-nic	p. 262	
Puzzle	p. 264	
Stairs	p. 266	
Surf	p. 267	
Ted	p. 271	
X	p. 272	

Ascension

Multifunctional seat / Seduta multifunzione

A handy accessory made of solid iroko wood with visible joints on the sides. A single object that, thanks to its versatility, offers two different functions depending on its position. Horizontally, it acts as a small step for the Immersion bathtub, while, if placed vertically, it doubles as a handy side table or storage area.

Comodo accessorio realizzato in massello di iroko con incastri a vista sui lati. Un solo oggetto che, grazie alla sua versatilità, regala due differenti funzioni a seconda della posizione. Posto in orizzontale, funge da scaletta per la vasca Immersion mentre in piedi si trasforma in un comodo tavolino o portaoggetti.

 AVAS1983I

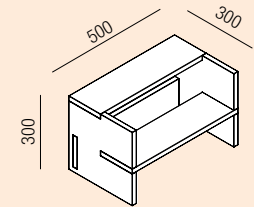

design Neri&Hu, 2018



Ascension

Multifunctional seat / Seduta multifunzione

**Basket, Midi Basket**

Containers / Contenitori

Roomy, cylindrical-shaped containers available in two sizes. Made of curved plywood and available in a natural, brown or dark oak finish or in reconstituted wood, teak finish or in white or grey.

The Basket container is a laundry storage unit that can also be used as a seat. Holes in the sides make it easy to move it. Midi Basket is a comfy waste paper for the bathroom.

Contenitori di forma cilindrica disponibili in due diverse dimensioni. Realizzati in multistrato curvato, disponibili con finitura in rovere naturale, bruno o scuro o in legno precomposto in finitura teak oppure nei colori bianco o grigio.

Basket è un portabiancheria utilizzabile anche come seduta. I fori sui lati permettono di spostarlo agevolmente.

Midi Basket è un comodo gettacarta per la stanza da bagno.

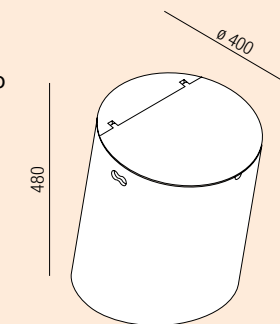
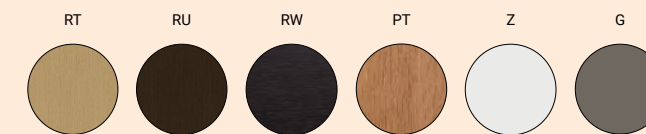
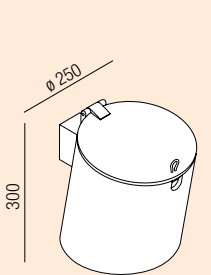
ACOM0510_
Basket**ACOM0601_**
Midi Basket

design Benedini Associati, 1992, 1996



Cavalletto

Bench / Panca

Bench in birch plywood available in natural, brown or dark oak finish, which can be combined with the Agapecasa bookcases of the same name range. Cavalletto is available in two dimensions and a black leather cushion consisting of two symmetrical parts can be added to it.

Panca realizzata in multistrati di betulla con finitura rovere naturale, bruno o scuro abbinabile all'omonimo programma di librerie Agapecasa. Cavalletto è disponibile in due dimensioni ed è accessoriabile con cuscino in pelle nera composto da due parti simmetriche.

ACVL0391_
ACVL0394NE

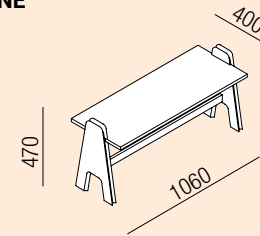

ACVL0392_
ACVL0394NE

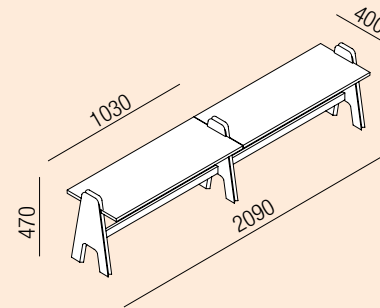

design Angelo Mangiarotti, 1953

RT

RU

RW



Cavalletto

Bench / Panca



Constellation

Extras / Complementi

Programme for bathroom storage accessories consisting of mirrors and containers with or without lids. Made of white Carrara or black Marquina marble. The post-modern shapes of the collection emphasise the sculptural aspect of smooth marble as if sculpted by water. The lids and details are in natural brushed brass.

Programma di complementi da appoggio per il bagno composto da specchi e da contenitori con o senza coperchio. Realizzato in marmo bianco di Carrara o nero Marquina. Le geometrie post-moderne della collezione enfatizzano l'aspetto scultoreo del marmo levigato come se fosse plasmato dall'acqua. I coperchi e i dettagli che caratterizzano gli oggetti sono realizzati in ottone naturale spazzolato.

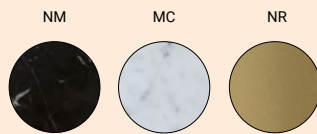

design Studiopepe, 2018



Constellation

Extras / Complementi

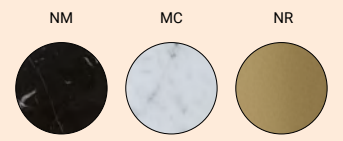

ACOM0306_

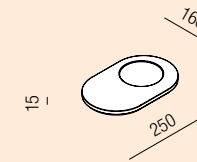

Tray / Vassoio

ACOM0302_

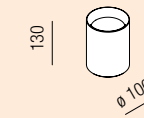

Objects container / Contenitore porta oggetti

ACOM0305_

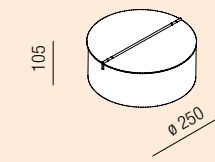

Objects container with lid / Contenitore porta oggetti con coperchio

Discover the Constellation collection mirrors at page 340 / Scopri gli specchi della collezione Constellation a pagina 340



Dot Line

Towel holders / Porta salviette

Free standing towel holder elaborating on the minimal geometries of the Dot Line family. Mobile and adaptable, at easy next to the bathtub just as near a washbasin or a bidet, Dot Line is available with its structure in black brushed anodized aluminium or covered in three different wood essences. The base can be ordered in four different marbles for a great number of different combinations.

Porta salviette da terra che riprende il rigore delle geometrie minime della famiglia Dot Line. Versatile e mobile, a suo agio vicino alla vasca così come accanto al lavabo o al bidet, Dot Line è disponibile con la struttura in alluminio spazzolato nero o rivestito in tre diverse essenze di legno e la base in quattro finiture di marmo per un grande numero di possibili combinazioni.

ADTL0462_

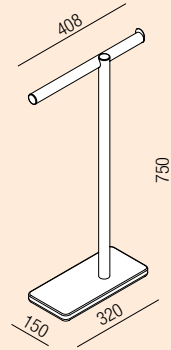

Line finish / Finitura barra

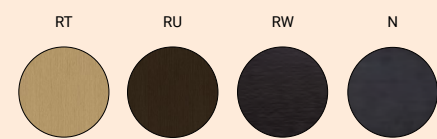

Base finish / Finitura base

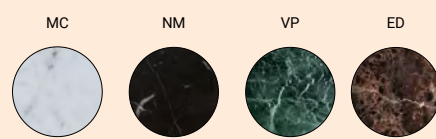

design García Cumini, 2016



Dot Line

Towel holders / Porta salviette



Discover
the Dot line
collection
accessories
at page 216
/ Scopri gli
accessori della
collezione Dot
line a pagina
216

Gemma

Extras / Complementi

Gemma is a program of bathroom complements consisting of containers with or without lid, trays and a small table. The trays/lids are made of stainless steel with satin or brushed burnished finish. The cylindrical containers in curved multi-layer birch plywood are clad with natural, brown or dark oak, or opaque lacquered white or grey. The top of the small table is also available with opaque white lacquered edge.

Gemma è un programma di complementi per il bagno composto da contenitori con o senza coperchio, vassoi e tavolino. I vassoi/coperchi sono realizzati in acciaio inox con finitura satinata o brunito spazzolato. I contenitori cilindrici in multistrato di betulla curvato hanno rivestimento in rovere naturale, bruno o scuro oppure sono laccati opachi in bianco o grigio. Il piano per il tavolino è disponibile anche con fascia esterna laccata in bianco opaco.

design Sebastian Herkner, 2016



Gemma

Extras / Complementi

ACOM255_

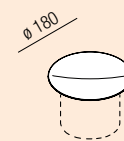

Tray or lid, \varnothing 180 mm for ACOM253 / Vassoio o coperchio, \varnothing 180 mm per ACOM253

ACOM256_

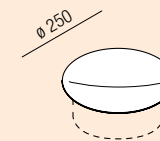

Tray or lid, \varnothing 250 mm for ACOM252 / Vassoio o coperchio, \varnothing 250 mm per ACOM252

ACOM257_

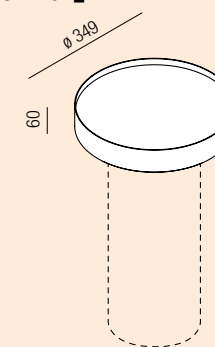

Small table top only to be used with ACOM251 / Piano per tavolino da utilizzare solo con ACOM251

ACOM251_

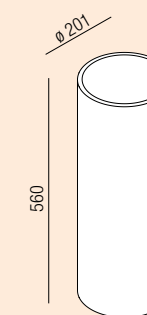

Container \varnothing mm 203 or base for small table (small table total height mm 580) / Contenitore \varnothing mm 203 o base per tavolino (altezza totale tavolino mm 580)

ACOM254_

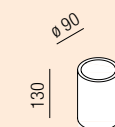

Container \varnothing mm 90 / Contenitore \varnothing mm 90

ACOM253_

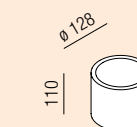

Container \varnothing mm 128 / Contenitore \varnothing mm 128

ACOM252_

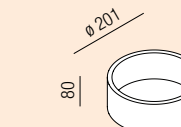

Container \varnothing mm 201 / Contenitore \varnothing mm 201

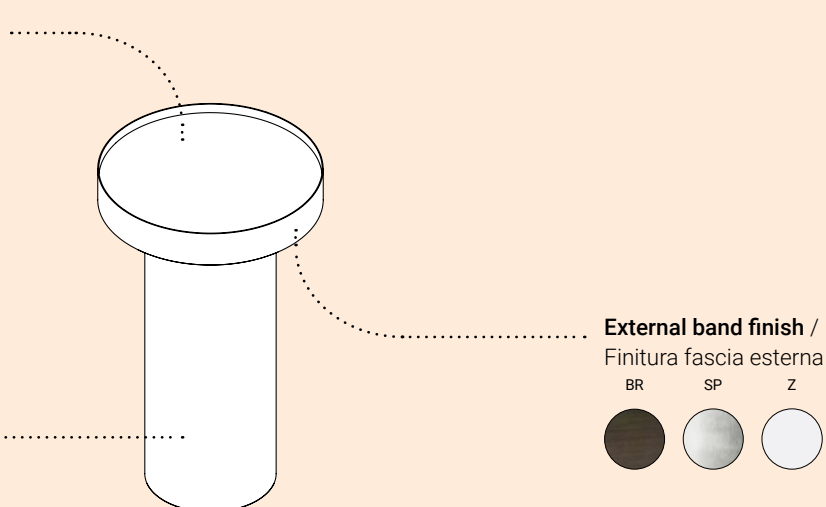
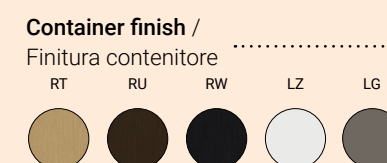

Memory

Towel holders / Porta salviette

Free-standing towel holder in stainless steel that inherits its delicate lines from the Memory Collection to which it belongs. Its ben calibrated geometries and timeless lines make it a very versatile object both functionally and aesthetically. The ideal complement to a free-standing bathtub or washbasin, Memory is available with chromed, brushed natural or burnished brass structure, while its base can be ordered in five different finishes between solid surface and marble.

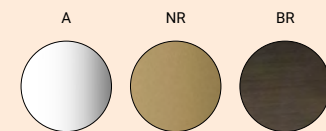

Base finish / Finitura base

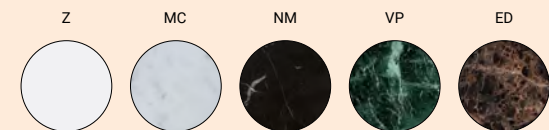

Porta salviette da terra in acciaio inox che eredita le sue delicate linee dalla collezione Memory a cui appartiene. Le sue geometrie ben calibrate e le sue linee senza tempo lo rendono un oggetto poliedrico sia dal punto di vista funzionale che da quello estetico. Complemento ideale di una vasca free-standing o di un lavabo a colonna, il porta salviette Memory è disponibile con la struttura cromata, ottone spazzolato naturale o brunito, mentre la base è ordinabile in cinque differenti finiture tra solid surface e marmo.

AMEM862_

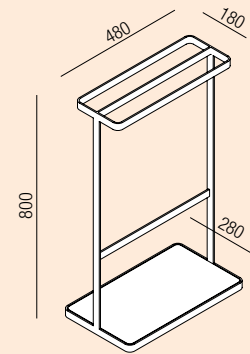

design Benedini Associati, 2010



Memory

Towel holders / Porta salviette

Discover
the Memory
collection
accessories
at page 230
/ Scopri gli
accessori della
collezione
Memory a
pagina 230

Multifunzione

Side tables / Servomuto

Completely made from white Exmar, this is a useful towel holder and shelf, to be placed near a bathtub or washbasin.

Tutto realizzato in Exmar bianco, è un comodo accessorio portaoggetti e portasalviette, da affiancare alla vasca o al lavabo.

ACOM0509Z

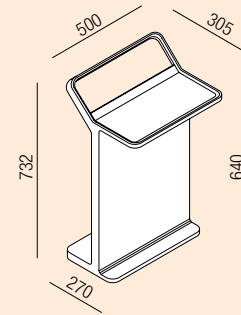

design Benedini Associati, 2009



Petra

Garden hose reel / Avvolgitubo per giardino

Support for garden irrigation hose realised in Cementoskin® (coloured concrete paste) available in different colours.

Supporto per tubo di irrigazione per giardino realizzato in Cementoskin® (cemento colorato in pasta) in diverse colorazioni.

 **ACER097_**

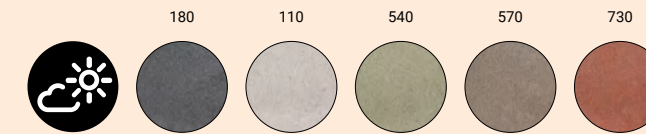
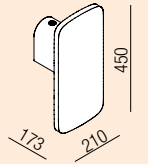

design Diego Vencato, Marco Merendi, 2018

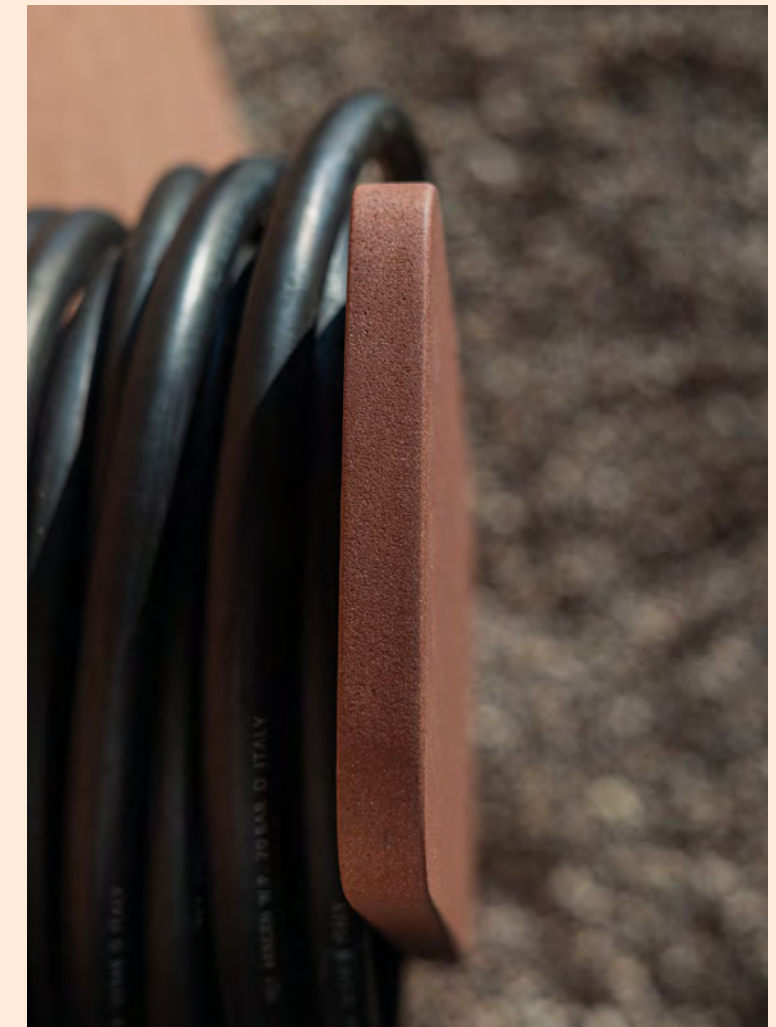
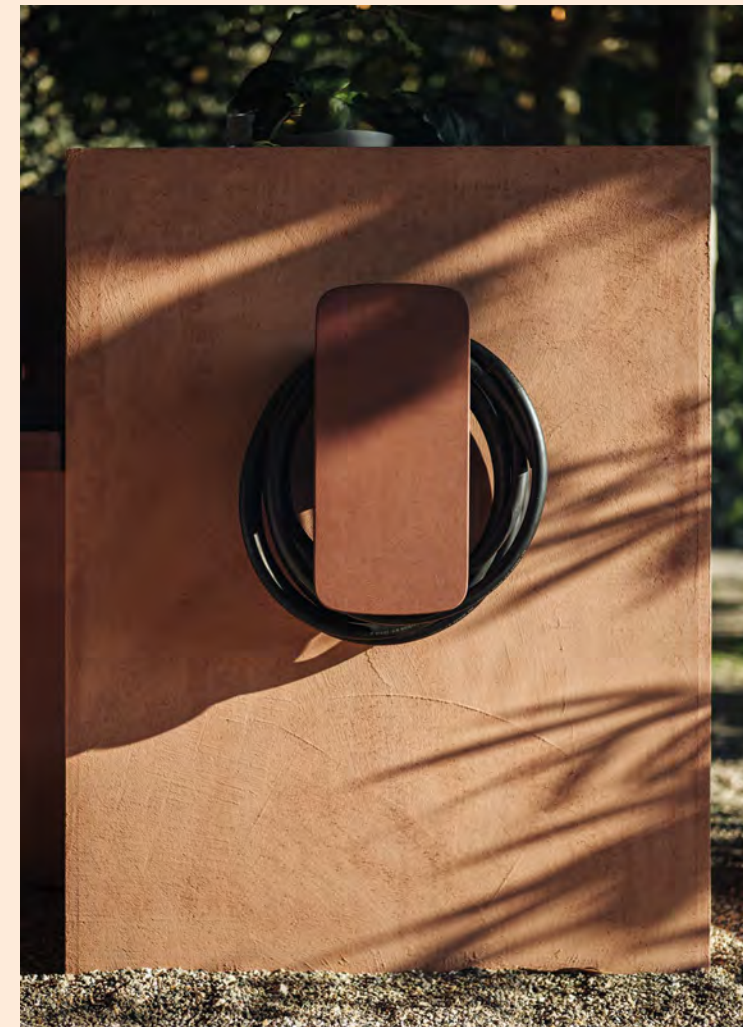

Pic-nic

Towel holders / Porta salviette

Floor standing towel holder in natural, brown, dark oak or painted teal or painted white or grey with embossed finish, with natural leather band, available in two different widths: 63 cm or 49 cm.

Portasalviette da terra in rovere naturale, bruno, scuro, tinto teak o verniciato in bianco o grigio, con fascia in cuoio naturale, disponibile in due larghezze cm 63 o cm 49.

ACOM0530_

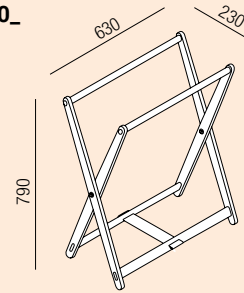

ACOM0530_S

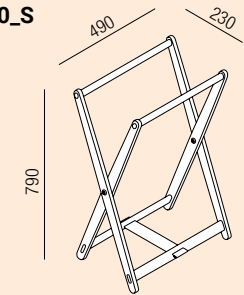

design Benedini Associati, 1993

**Pic-nic**

Towel holders / Porta salviette



Puzzle

Extras / Complementi

Countertop or drawer accessories to use in the containers of the Agape programmes. Made of massive ash wood, grey painted with open-pore finish. The different boxes can be positioned individually or inserted in the respective tray in various positions.

Accessori da appoggio o per cassetti da inserire nei contenitori dei programmi Agape. Realizzati in massello di frassino con verniciatura laccata grigia a poro aperto. I vari box possono essere posizionati singolarmente o inseriti nel vassoio in più posizioni.

GR

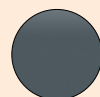

design Benedini Associati, 2011



Puzzle

Extras / Complementi

GR



ALEG524GR

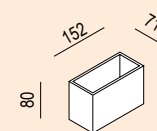

Small-low box / Box piccolo-basso

ALEG525GR

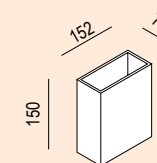

Small-high box / Box piccolo-alto

ALEG526GR

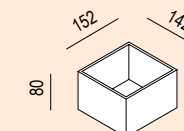

Large-low box / Box grande-basso

ALEG527GR

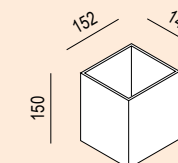

Large-high box / Box grande-alto

ALEG528GR

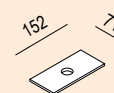

Cover for small box / Coperchio per box piccolo

ALEG529GR

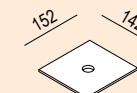

Cover for large box / Coperchio per box grande

ALEG532GR

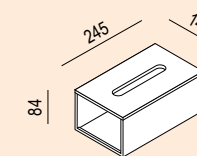

Tissue dispenser / Porta kleenex

ALEG540GR

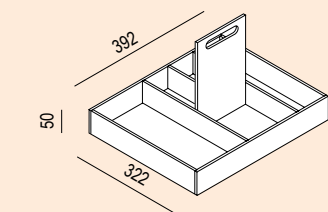

Vassoio o porta contenitori / Shelf or support for boxes

Stairs

Extras / Complementi

Towel rail or bookshelf white five shelves in natural or dark oak or white painted finish, floor standing and resting against the wall.

Elemento porta salviette o elemento con cinque ripiani in rovere naturale, scuro o verniciato in bianco, in appoggio a terra e alla parete.

ACOM0531N_

ACOM0534N_

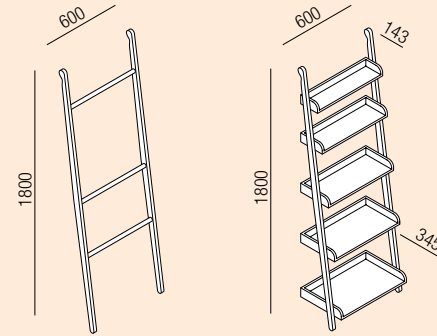

design Benedini Associati, 1996



Surf

Extras / Complementi

White Cristalplant® countertop accessories for the washbasin area. They can also be placed on the Surf trays, made in the same material or in marble.

Elementi d'appoggio per la zona lavabo realizzati in Cristalplant® bianco. Possono essere collocati anche sui vassoi porta oggetti Surf realizzati nello stesso materiale o in marmo.

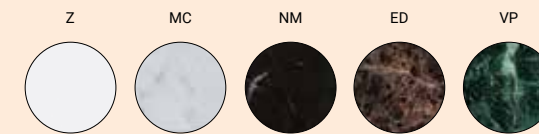

design Benedini Associati, 2007



Surf

Extras / Complementi



Surf

Extras / Complementi



Surf

Extras / Complementi

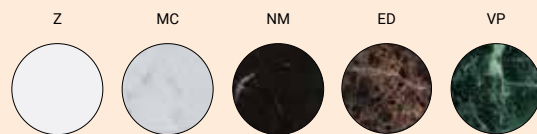

ACOM0631Z

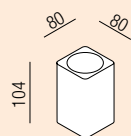

Countertop toothbrush holder /
Porta spazzolini d'appoggio

ACOM0632Z

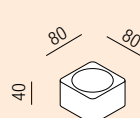

Countertop container for
accessories / Contenitore porta
oggetti d'appoggio

ACOM0633Z

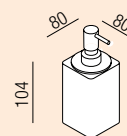

Countertop liquid soap
dispenser (30 cl) with steel
spout / Dispenser per sapone
liquido d'appoggio (30 cl)
con erogatore in acciaio

ACOM0634Z

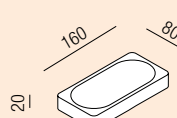

Countertop soap holder / Porta
sapone d'appoggio

ACOM0626_

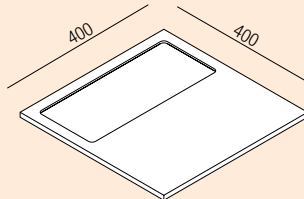

Soap dish/multipurpose trays
in white Cristalplant® or in
marble; can be placed on
countertops / Vassoio porta
oggetti/porta sapone realizzati
in Cristalplant® bianco o in
marmo, può essere utilizzato in
appoggio sui piani

ACOM0627_

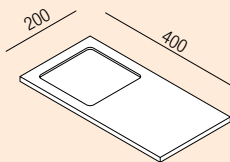

Soap dish/multipurpose trays
in white Cristalplant® or in
marble; can be placed on
countertops / Vassoio porta
oggetti/porta sapone realizzati
in Cristalplant® bianco o in
marmo, può essere utilizzato in
appoggio sui piani

Ted

Side tables / Servomuto

A practical tool for the organization of the bathroom, always at hand. Freestanding and adjustable in height, with shelf, towel rack and toilet roll holder in polished stainless steel with basis and shelf in white solid surface, to complement washbasins, bathtub or sanitary ware.

Un pratico strumento per l'organizzazione dell'ambiente bagno sempre a portata di mano. Accessorio da terra regolabile in altezza con porta oggetti, portasalviette e porta rotolo in acciaio inox lucido con base e ripiano in solid surface bianco, da affiancare a mobili, lavabo, vasca o sanitari.

ACOM0514Z

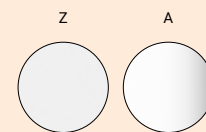
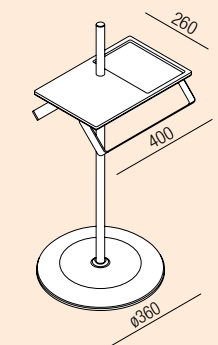

design Daniele Dalla Pellegrina, 2013



X

Extras / Complementi

A handy, versatile wooden accessory in natural, brown, dark oak or painted teal or painted white or grey. The structure can be accessorised with a tray to create a handy table or portable storage shelf. Without the tray, the tall structure becomes a handy towel rack.

Un comodo accessorio realizzato in rovere naturale, bruno, scuro, tinto teak o verniciato in bianco o grigio. La struttura può essere accessoriata con il vassoio, utilizzabile come tavolino o portaoggetti. Senza vassoio la struttura alta è un pratico porta salviette.

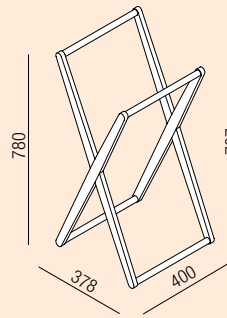
AMET1877

Asymmetric towel holder / Porta salviette asimmetrico

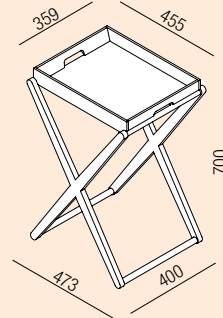
ACOM0622

Table, high, with removable tray / Tavolino alto con vassoio asportabile

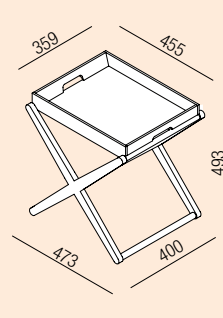
ACOM0623

Table, low, with removable tray / Tavolino basso con vassoio asportabile

RT

RU

RW

TT

Z

G



design Benedini Associati, 2012

**X**

Extras / Complementi



Taps / Rubinetti

A collection with the right mix of technology and design, to complement and customise your Agape bathroom. External and recessed taps, with single or dual controls, produced in brass, stainless steel or aluminium, and featuring an original design and absolute quality.

Una collezione con il giusto grado di tecnologia e di design, per completare e personalizzare il bagno Agape. Rubinetti esterni, a incasso, monocomando o con due comandi. Realizzati in ottone, acciaio inox o alluminio, sono caratterizzati da un design originale e da una qualità totale.



for washbasin / per lavabo for bidet / per bidet for bathtub / per vasca for shower / per doccia wc plates / placca wc

Fez 2	p. 277	●	●	●	●	
Limón	p. 284	●	●	●	●	●
Memory	p. 290	●	●	●	●	●
Memory Mix	p. 298	●	●	●	●	●
Sen	p. 304	●	●	●	●	●
Square	p. 310	☀	●	☀	☀	●

Finishes taps / Finiture rubinetti

	S	A	SP	Z	E	N	BR	NR	CU	GM	NI	NL
Fez 2	●			●	●							
Limón	●			●*	●		●	●	●*	●*	●*	●*
Memory	●			●*	●		●	●	●*	●*	●*	●*
Memory Mix	●			●*	●		●	●	●*	●*	●*	●*
Sen						●						
Square		●	●									

☀ Items marked with this symbol are part of the Outdoor Collection and can also be used outdoors / Gli articoli contrassegnati con questo simbolo fanno parte della Collezione Outdoor e possono essere utilizzati anche all'esterno

* On demand / A richiesta

Fez 2

Taps / Rubinetti

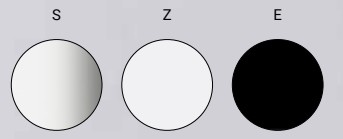

The long-seller Fez has undergone a deep restyling of the internal parts aimed to improve the quality and the certifiability of the product. Thus was born Fez 2 which distinguishes itself externally for redesigned, shorter control handle, manufactured in one piece instead of the three of the original series. From the version for wall mounted or over countertop basins to the floor-mounted version to complete a freestanding washbasin, to the model for bidets. Fez 2 proves equally flexible in the bathtub or shower, with purpose-made sets, all featuring the same unmistakable design. Made in brass with polished chrome finish or painted matt white (RAL9016) or matt black (RAL9005), produced in collaboration with "Rubinetterie Fantini".

La long-seller Fez è stata sottoposta ad una profonda revisione delle parti interne volta a migliorare la qualità e la certificabilità del prodotto. Nasce così Fez 2, che si distingue esternamente per la maniglia di comando, più corta e riprogettata per essere realizzata in un solo pezzo al posto dei tre della serie originale. Dalla versione per lavabi a muro o su piano alla versione a terra per completare un lavabo freestanding, al modello da bidet. Fez 2 rivela la sua flessibilità anche nella vasca da bagno e nello spazio doccia, con gruppi specifici sempre caratterizzati da un inconfondibile design. Realizzata in ottone con finitura cromo lucido o verniciata in bianco opaco (RAL9016) o nero opaco (RAL9005), in collaborazione con "Rubinetterie Fantini".

design Benedini Associati, 2018



Washbasin single hole mixer tap /
Miscelatore lavabo monoforo

Fez 2

Taps / Rubinetti

Built-in washbasin mixer tap /
 Miscelatore per lavabo ad incasso
 Marsiglia – washbasin / lavabo

**Fez 2**

Taps / Rubinetti

Floor standing spout / Bocca di erogazione a pavimento
 Bjhon 2 – washbasin / lavabo



Fez 2

Taps / Rubinetti

Single-lever built-in mixer tap /
Miscelatore monocomando ad incasso



Fez 2

Taps / Rubinetti

Floor standing spout / Bocca di erogazione a pavimento
Spoon XL – bathtub / vasca



Fez 2

Taps / Rubinetti

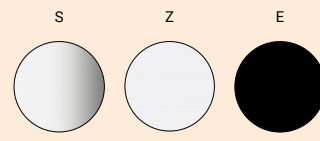

Washbasin taps / Gruppi lavabo

AFEZ001_

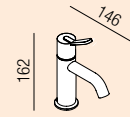

Brass single-hole mixer tap for washbasin without pop-up plug lever / Miscelatore lavabo monoforo, senza comando per piletta

AFEZ002_

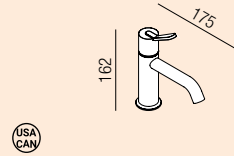

Brass single-hole mixer tap for washbasin without pop-up plug lever / Miscelatore lavabo monoforo, senza comando per piletta

AFEZ003_

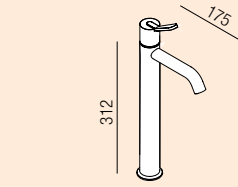

Brass single-hole mixer tap for washbasin without pop-up plug lever / Miscelatore lavabo monoforo, senza comando per piletta

ARUB1460000_

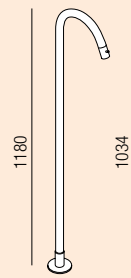

Floor standing spout with flow regulator. Temperature is not managed / Bocca di erogazione a pavimento con regolatore di flusso. Temperatura non gestita.

.MET884

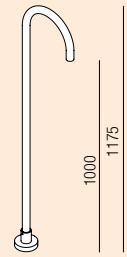

Floor standing washbasin spout. Flow and temperature regulation not managed / Bocca di erogazione a pavimento per lavabo. Regolazione di flusso e di temperatura non gestita.

.EFEZ004_+.IFEZ004

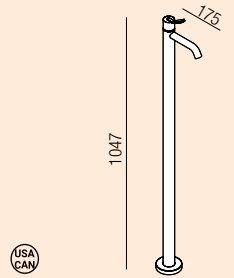

Floor mounted single hole lever mixer for washbasin / Miscelatore monoforo per lavabo, predisposto per fissaggio a pavimento

.EFEZ011_+.IFEZ010

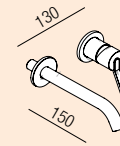

Built-in single lever washbasin mixer tap, 15 cm / Miscelatore monocomando per lavabo ad incasso, bocca cm 15

.EFEZ012_+.IFEZ010

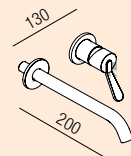

Built-in single lever washbasin mixer tap, 20 cm / Miscelatore monocomando per lavabo ad incasso, bocca cm 20

Bidet taps / Gruppi bidet

AFEZ008_

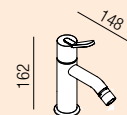

Single-hole mixer tap for bidet without pop-up plug lever / Miscelatore bidet monoforo senza comando per piletta

Washbasin, bathtub, shower taps / Gruppi lavabo, vasca, doccia

Fez 2

Taps / Rubinetti

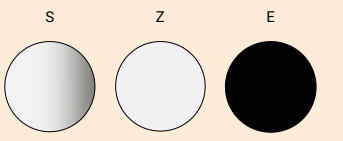

.EFEZ007_+.IFEZ007



Single-lever built-in mixer tap for washbasin or shower without spout / Miscelatore monocomando ad incasso per lavabo o doccia senza bocca

.EFEZ031_+.IFEZ031



Single-lever built-in mixer tap with two-way diverter / Miscelatore monocomando ad incasso con deviatore a due vie

.EFEZ032_+.IFEZ032

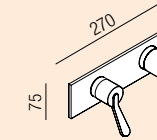

Thermostatic built-in mixer tap with two way diverter / Miscelatore termostatico ad incasso con deviatore a due vie

.EFEZ033_+.IFEZ033

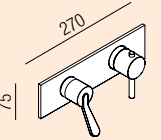

Thermostatic built-in mixer tap with three way diverter / Miscelatore termostatico ad incasso con deviatore a tre vie

.EFEZ034_+.IFEZ034



Thermostatic single-lever built-in mixer tap / Miscelatore monocomando termostatico ad incasso

.EFEZ035_+.IFEZ035



Stop tap / Rubinetto d'arresto

Bathtub taps / Gruppi vasca

.EFEZ028_+.IFEZ028

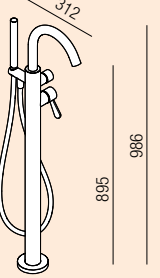

External set for bathtub with diverter and hand-held shower support / Gruppo esterno per vasca con deviatore e supporto per doccia

.MET885

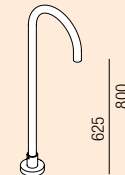

Floor standing bathtub spout. Flow and temperature regulation not managed / Bocca di erogazione a pavimento per vasca. Regolazione di flusso e di temperatura non gestita.

.EFEZ027

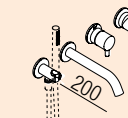

Bathtub set including single-lever mixer tap, diverter and hand-held shower support, spout 20 cm / Gruppo per vasca completo di miscelatore monocomando, deviatore e supporto per doccia, bocca cm 20



Items marked with this symbol are available with certification for the USA and Canada markets / Gli articoli contrassegnati con questo simbolo sono disponibili con certificazione per mercato USA e Canada

Limón

Taps / Rubinetti



Meeting and mating with its own circular section, just like in the age-old concept of agricultural grafting, has transformed the seemingly elemental geometries of Limón in something completely different. A new and fresh breed of brass taps that communicate its structure and intended use with unusual honesty and clarity. Limón is available for every functional need in a great variety of finishes, chrome, burnished and brushed, natural brushed brass or matt black-coated.

L'incontro e l'unione con la propria sezione circolare, come nella tradizione dell'innesto agricolo, trasforma le geometrie apparentemente elementari di Limón in qualcosa di completamente diverso. Una nuova e fresca tipologia di rubinetti in ottone che comunica la propria struttura e la destinazione d'uso con inusuale onestà e chiarezza.

Limón è disponibile per ogni esigenza funzionale in una grande varietà di finiture, cromata, brunito spazzolata, ottone naturale spazzolato o verniciata in nero opaco.

design Patricia Urquiola, 2021

Selected "ADI FAD" 2022
Winner "EDIDA" Ucraina 2021



Washbasin single hole mixer tap /
Miscelatore lavabo monoforo

Limón

Taps / Rubinetti



Washbasin single hole mixer tap /
Miscelatore lavabo monoforo

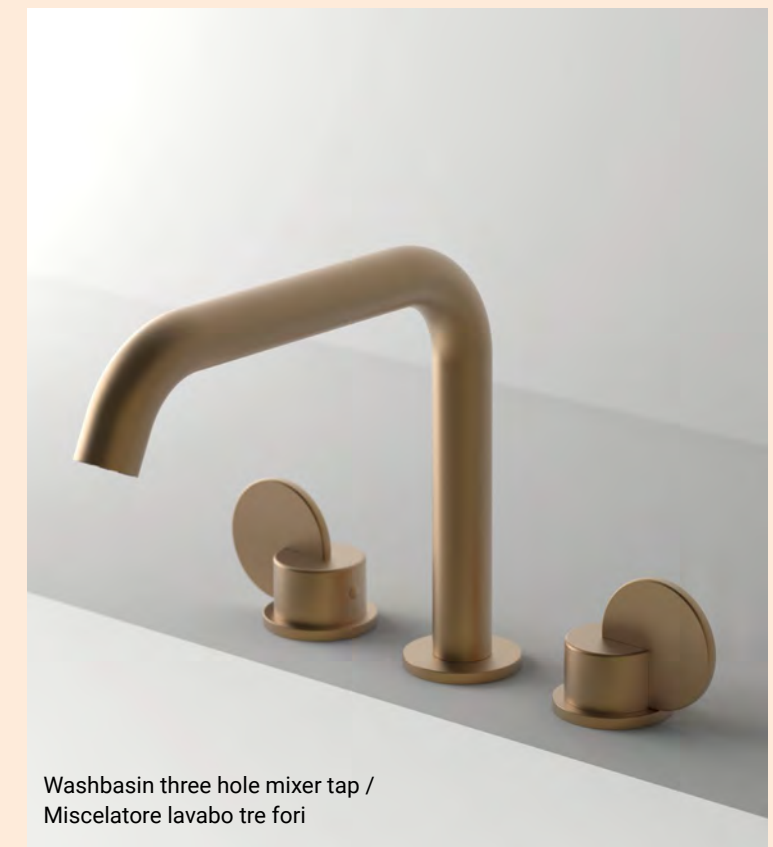

Washbasin three hole mixer tap /
Miscelatore lavabo tre fori



Wall-mounted three hole washbasin mixer tap /
Miscelatore lavabo tre fori da parete

Limón

Taps / Rubinetti



Thermostatic bathtub taps set / Gruppo termostatico per vasca

Limón

Taps / Rubinetti

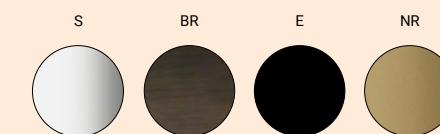

Washbasin

taps / Gruppi lavabo

ALIM411D_

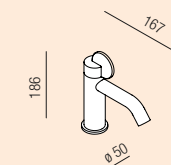

Washbasin single hole mixer tap, with flexible water main connection hoses / Miscelatore lavabo monoforo, con flessibili di alimentazione

ALIM412D_

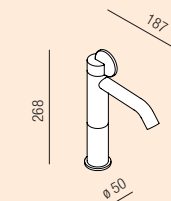

Washbasin single hole mixer tap, with flexible water main connection hoses / Miscelatore lavabo monoforo, con flessibili di alimentazione

ALIM413D_

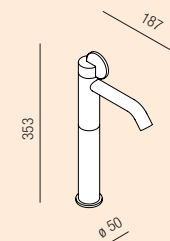

Washbasin single hole mixer tap, with flexible water main connection hoses / Miscelatore lavabo monoforo, con flessibili di alimentazione

ALIM415D_

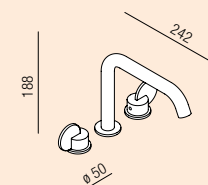

Washbasin tap set designed to fit three holes with double control and flexible water main connection hoses / Gruppo a tre fori con doppio comando e flessibili di alimentazione, per lavabo

ALIX271

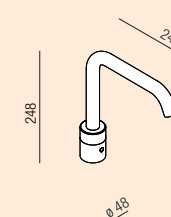

Countertop washbasin group with electronic sensor, equipped with external solenoid valve / Gruppo lavabo da piano con sensore elettronico, dotato di elettrovalvola esterna

.ELIM414D_+.ILIX414D

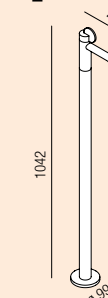

Floor mounted single hole lever mixer for washbasin / Miscelatore monoforo per lavabo, predisposto per fissaggio a pavimento

.EMEM323_+.IMEM327

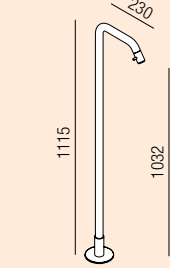

Floor standing spout with flow regulator. Temperature regulation is not managed. H 111,5 cm / Bocca di erogazione a pavimento con regolatore di flusso. Senza regolazione di temperatura. H cm 111,5

.ELIM422_+.ILIX420

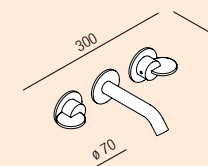

Built-in washbasin tap with dual control / Gruppo lavabo da incasso a doppio comando

.ELIM432D_+.ILIX431D

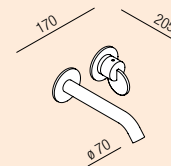

Built-in washbasin mixer tap / Miscelatore ad incasso per lavabo

Bidet taps / Gruppi bidet

ALIM416D_

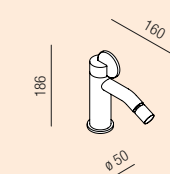

Single hole mixer tap for bidet, with flexible water main connection hoses / Miscelatore per bidet monoforo, con flessibili di alimentazione

Limón

Taps / Rubinetti



Bathtub taps / Gruppi vasca

.ELIM437D_+.ILIX431D

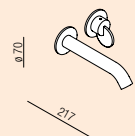

Built-in bathtub mixer /
Miscelatore ad incasso per
vasca

.ELIM443_+.ILIX443

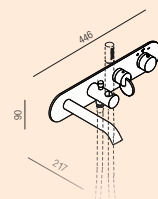

**Thermostatic bathtub taps
set with diverter and hand
held shower support /** Gruppo
termostatico ad incasso per
vasca, con deviatore e supporto
per doccia

.ELIM425_+.ILIX425

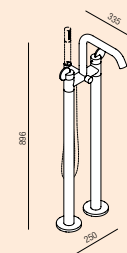

**Floor mounted bathtub tap with
dual control, flow deviator and
water connection for hand-held
shower /** Gruppo vasca a doppio
comando con deviatore e presa
d'acqua per doccia, fissaggio a
pavimento

Limón

Taps / Rubinetti



.ELIM436D_+.ILIX436D

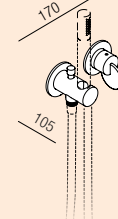

**Built-in single lever tap
unit with flow deviator and
hand-held shower holder /**
Miscelatore monocomando
ad incasso con deviatore e
supporto per doccia

.ELIM441_+.ILIX441

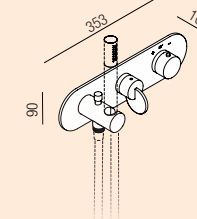

**Built-in thermostatic tap unit
with flow deviator and hand-
held shower holder /** Comando
termostatico ad incasso con
deviatore e supporto per
doccia

Wc control plaque / Placca per controllo WC

ARUB0968N_

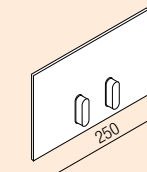

**Control plaque for recessed flush
tank with dual flushing capacity;
available in stainless steel /**
Placca comando di risciacquo
per cassetta ad incasso, con due
differenti quantità di risciacquo, in
acciaio inox

.EMEM327_+.IMEM327

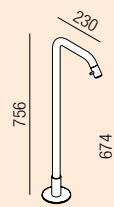

**Floor standing spout with
flow regulation. Temperature
regulation not managed /** Bocca
di erogazione a pavimento con
regolatore di flusso, regolazione
di temperatura non gestita

Bathtub, shower taps / Gruppi vasca, doccia

.ELIM430D_+.ILIX430D

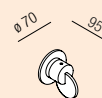

Built-in mixer tap / Miscelatore
monocomando ad incasso

.ELIM440D_+.ILIX440D

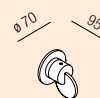

Stop tap / Rubinetto d'arresto

.ELIX450_+.ILIX450

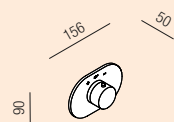

**Built-in thermostatic valve
/** Comando termostatico ad
incasso

.ELIM451_+.ILIX451

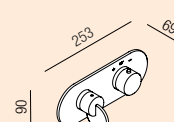

**Built-in thermostatic set with
flow regulation with single
output /** Comando termostatico
ad incasso con regolazione di
flusso ad una uscita

.ELIM452_+.ILIX452

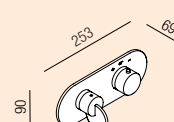

**Built-in thermostatic set with
flow regulation with two outputs
/** Comando termostatico ad
incasso con regolazione di
flusso a due uscite

.ELIM435D_+.ILIX431D

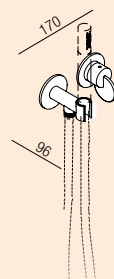

**Built-in single tap unit and
hand-held shower holder /**
Miscelatore monocomando
ad incasso con supporto per
doccia

Memory

Taps / Rubinetti



Memory blends tradition with modernity, giving a collection inspired by the past to complete and customise the contemporary bathroom. Brass taps with chrome, brushed burnished, natural brushed brass or matt black-coated (RAL9005) finish featuring a cross-shaped handle and concealed aerators.

Tradizione e attualità si fondono in Memory, una collezione che si ispira al passato per completare e personalizzare il bagno contemporaneo. Rubinetteria in ottone con finitura cromata, brunito spazzolata, ottone naturale spazzolato o verniciata in nero opaco (RAL9005) caratterizzata dalla maniglia a croce e dagli areatori a scomparsa.

design Benedini Associati, 2018



Washbasin single hole mixer tap /
Miscelatore lavabo monoforo

 agape

Memory

Taps / Rubinetti

Floor standing spout / Bocca di erogazione a pavimento
Bjhon 1 – washbasin / lavabo



 agape

Memory

Taps / Rubinetti

Built-in washbasin tap with dual control / Gruppo lavabo da incasso a doppio comando
Bjhon 1 – washbasin / lavabo



Memory

Taps / Rubinetti



Floor standing spout / Bocca di erogazione a pavimento
In-Out – bathtub / vasca

Memory

Taps / Rubinetti

Built-in thermostatic bathtub tap unit with flow deviator and handheld shower holder / Gruppo vasca termostatico ad incasso con deviatore e supporto per doccia

**Memory**

Taps / Rubinetti



Floor mounted bathtub tap / Gruppo per vasca a pavimento
In-Out – bathtub / vasca

Memory

Taps / Rubinetti



Washbasin taps / Gruppi lavabo

AMEM311_

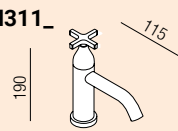

Washbasin single hole mixer tap, with single gradual flow control / Miselatore lavabo monoforo, monocomando a funzionamento progressivo

AMEM312_

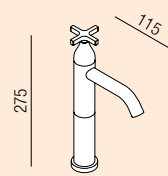

Washbasin single hole mixer tap, with single gradual flow control / Miselatore lavabo monoforo, monocomando a funzionamento progressivo

AMEM313_

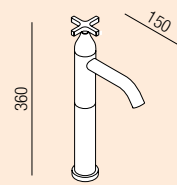

Washbasin single hole mixer tap, with single gradual flow control / Miselatore lavabo monoforo, monocomando a funzionamento progressivo

AMEM315_

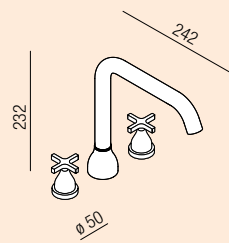

Washbasin tap set designed to fit three holes / Gruppo lavabo a tre fori

ALIX271_

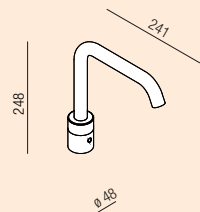

Countertop washbasin group with electronic sensor, equipped with external solenoid valve / Gruppo lavabo da piano con sensore elettronico, dotato di elettrovalvola esterna

.EMEM323_+.IMEM327

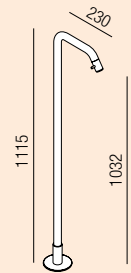

Floor standing spout with flow regulator. Temperature regulation is not managed. H 111,5 cm / Bocca di erogazione a pavimento con regolatore di flusso. Senza regolazione di temperatura. H cm 111,5

.EMEM322_+.IMEM320

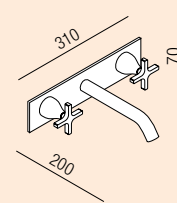

Built-in washbasin tap with dual control / Gruppo lavabo da incasso a doppio comando

.EMEM332_+.IMEM331

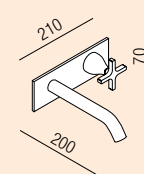

Built-in washbasin mixer tap with single gradual flow control / Gruppo lavabo ad incasso monocomando a funzionamento progressivo

Bidet taps / Gruppi bidet

AMEM316_

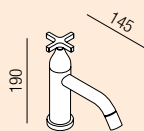

Bidet mixer tap with single gradual flow control / Miselatore monoforo bidet, monocomando a funzionamento progressivo

.EMEM317_+.IMEM317

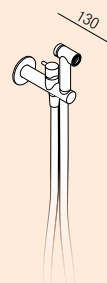

Bidet mixer tap with hand-held shower / Miselatore per bidet con doccia

Bathtub taps / Gruppi vasca

.EMEM343_+.IMEM343

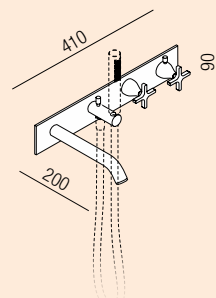

Built-in thermostatic bathtub tap unit with flow deviator and handheld shower holder / Gruppo vasca termostatico ad incasso con deviatore e supporto per doccia

.EMEM341_+.IMEM341

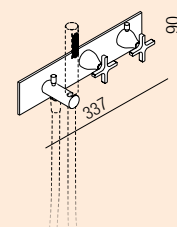

Built-in thermostatic tap unit with flow deviator and hand-held shower holder / Gruppo termostatico ad incasso con deviatore e supporto per doccia

Wc control plaque / Placca per controllo WC

ARUB0968N_

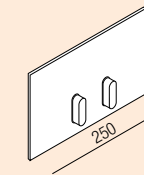

Control plaque for recessed flush tank with dual flushing capacity; available in stainless steel / Placca comando di risciacquo per cassetta ad incasso, con due differenti quantità di risciacquo, in acciaio inox

Memory

Taps / Rubinetti



.EMEM327_+.IMEM327

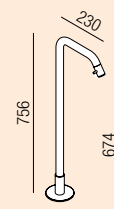

Floor standing spout with flow regulation. Temperature regulation not managed / Bocca di erogazione a pavimento con regolatore di flusso, regolazione di temperatura non gestita

.EMEM325_+.IMEM325

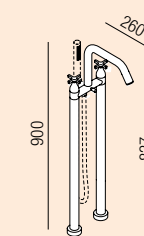

Floor mounted bathtub tap with dual control, flow deviator and water connection for hand-held shower / Gruppo per vasca a doppio comando a pavimento, con deviatore e presa d'acqua per doccia

AMEM326_

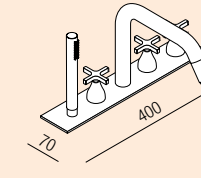

Tap set for the bath with dual control for bathtub spout and single-lever mixer tap for hand-held shower / Gruppo vasca, con doppio comando per bocca vasca e miscelatore monocomando per doccia

Bathtub, shower taps / Gruppi vasca, doccia

.EMEM340_+.IMEM340



Stop tap / Rubinetto d'arresto

.EMEM330_+.IMEM330

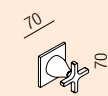

Built-in mixer tap with single gradual flow control / Miselatore monocomando ad incasso a funzionamento progressivo

.EMEM350_+.IMEM350

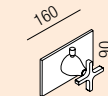

Thermostatic valve without flow regulation / Valvola termostatica senza regolazione di flusso

.EMEM351_+.IMEM351



Thermostatic set with flow regulation with single output / Gruppo termostatico con regolazione di flusso ad una uscita

.EMEM336_+.IMEM336

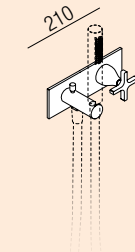

Built-in single lever tap unit with gradual flow control with flow deviator and hand-held shower holder / Gruppo monocomando ad incasso a funzionamento progressivo con deviatore e supporto per doccia

Discover the Memory collection accessories at page 230 / Scopri gli accessori della collezione Memory a pagina 230

Memory Mix

Taps / Rubinetti



Brass taps with different finishes featured by the new lever that takes its shape directly from the iconic cross handle of the Memory series. The new single lever is twice as long as a “conventional” Memory handle arm. Its width has been adjusted and slightly enlarged to be ergonomically consistent with the new usage model.

Rubinetteria in ottone con diverse finiture caratterizzata dalla nuova leva che prende la sua forma direttamente dall'iconica maniglia a croce della serie Memory. La nuova leva singola è lunga il doppio di un braccio dell'impugnatura Memory “convenzionale”. La sua larghezza è stata regolata e leggermente allargata per essere ergonomicamente coerente con il nuovo modello di utilizzo.

design Benedini Associati, 2021



Washbasin single hole mixer tap /
Miscelatore lavabo monoforo

Memory Mix

Taps / Rubinetti



Built-in single lever tap unit / Miscelatore monocomando ad incasso
Floor standing spout / Bocca di erogazione a pavimento

Memory Mix

Taps / Rubinetti



Wall-mounted three hole washbasin mixer tap /
Miscelatore lavabo tre fori da parete



Washbasin single hole mixer tap /
Miscelatore lavabo monoforo

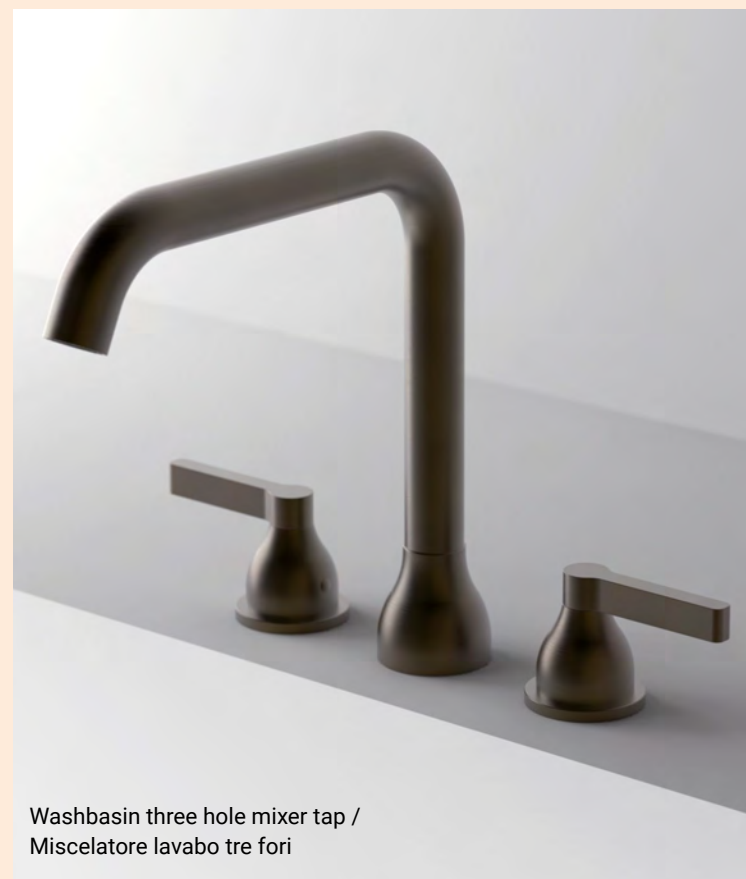

Washbasin three hole mixer tap /
Miscelatore lavabo tre fori

Memory Mix

Taps / Rubinetti



Washbasin taps / Gruppi lavabo

AMIX411D_

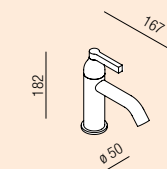

Washbasin single hole mixer
tap, with flexible water main
connection hoses / Miscelatore
lavabo monoforo, con flessibili
di alimentazione

AMIX412D_

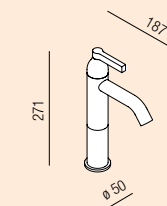

Washbasin single hole mixer
tap, with flexible water main
connection hoses / Miscelatore
lavabo monoforo, con flessibili
di alimentazione

AMIX413D_

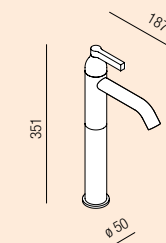

Washbasin single hole mixer
tap, with flexible water main
connection hoses / Miscelatore
lavabo monoforo, con flessibili
di alimentazione

AMIX415D_

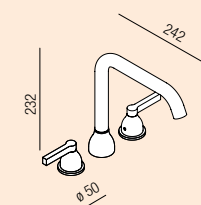

Washbasin tap set designed
to fit three holes with double
control and flexible water
main connection hoses /
Gruppo lavabo a tre fori con
doppio comando e flessibili di
alimentazione

ALIX271

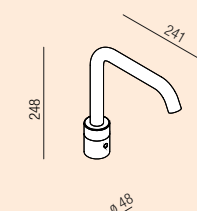

Countertop washbasin
group with electronic sensor,
equipped with external solenoid
valve / Gruppo lavabo da piano
con sensore elettronico, dotato
di elettrovalvola esterna

.EMIX414D_+.ILIX414D

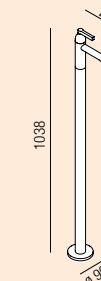

Floor mounted single hole
lever mixer for washbasin
/ Miscelatore monoforo
per lavabo, predisposto per
fissaggio a pavimento

.EMEM323_+.IMEM327

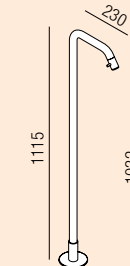

Floor standing spout with flow
regulator. Temperature regulation
is not managed. H 111,5 cm /
Bocca di erogazione a pavimento
con regolatore di flusso. Senza
regolazione di temperatura.
H cm 111,5

.EMIX422_+.ILIX420

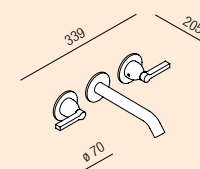

Built-in washbasin tap with
dual control / Gruppo lavabo da
incasso a doppio comando

.EMIX432D_+.ILIX431D

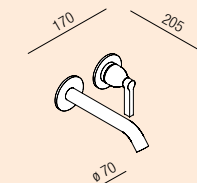

Built-in washbasin mixer tap
/ Miscelatore ad incasso per
lavabo

Bidet taps / Gruppi bidet

AMIX416D_

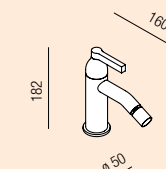

Single hole mixer tap for
bidet, with flexible water main
connection hoses / Miscelatore
per bidet monoforo, con flessibili
di alimentazione

Memory Mix

Taps / Rubinetti



Bathtub taps / Gruppi vasca

.EMIX437D_+.ILIX431D

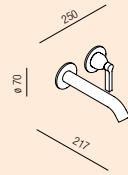

Built-in bathtub mixer /
Miscelatore ad incasso per vasca

.EMIX443_+.ILIX443

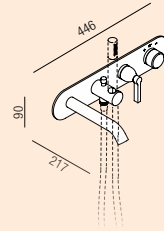

**Thermostatic bathtub tap set
with diverter and hand held
shower support / Gruppo**
termostatico ad incasso per
vasca, con deviatore e supporto
per doccia

.EMIX425_+.ILIX425

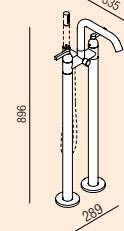

**Floor mounted bathtub tap with
dual control, flow deviator and
water connection for hand-held
shower / Gruppo per vasca a
doppio comando con deviatore
e presa d'acqua per doccia,
predisposto per fissaggio
a pavimento**

Memory Mix

Taps / Rubinetti



.EMIX436D_+.ILIX436D

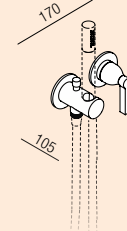

**Built-in single lever tap
unit with flow deviator and
hand-held shower holder /**
Miscelatore monocomando
ad incasso con deviatore e
supporto per doccia

.EMIX441_+.ILIX441

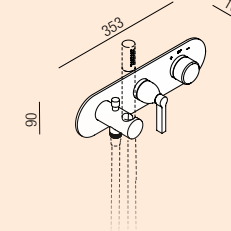

**Built-in thermostatic tap unit
with flow deviator and hand-
held shower holder / Comando**
termostatico ad incasso con
deviatore e supporto per doccia

Wc control plaque / Placca per controllo WC

ARUB0968N_

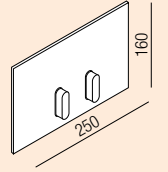

**Control plaque for recessed flush
tank with dual flushing capacity;
available in stainless steel /**
Placca comando di risciacquo
per cassetta ad incasso, con due
differenti quantità di risciacquo, in
acciaio inox

.EMEM327_+.IMEM327

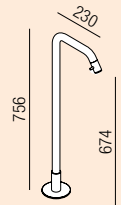

**Floor standing spout with
flow regulation. Temperature
regulation not managed / Bocca**
di erogazione a pavimento con
regolatore di flusso, regolazione
di temperatura non gestita

Bathtub, shower taps / Gruppi vasca, doccia

.EMIX430D_+.ILIX430D

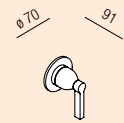

Built-in mixer tap / Miscelatore
monocomando ad incasso

.EMIX440D_+.ILIX440D

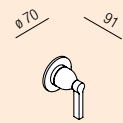

Stop tap / Rubinetto d'arresto

.ELIX450_+.ILIX450

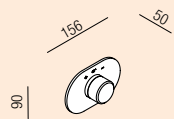

Built-in thermostatic valve
/ Comando termostatico ad
incasso

.EMIX451_+.ILIX451

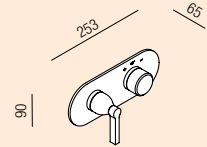

**Built-in thermostatic set with
flow regulation with single
output / Comando termostatico**
ad incasso con regolazione di
flusso ad una uscita

.EMIX452_+.ILIX452

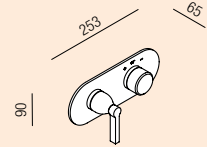

**Built-in thermostatic set with
flow regulation with two outputs**
/ Comando termostatico ad
incasso con regolazione di flusso
a due uscite

.EMIX435D_+.ILIX431D

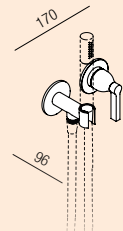

**Built-in single lever tap unit
and hand-held shower holder**
/ Miscelatore monocomando
ad incasso con supporto per
doccia

**Discover
the Memory
collection
accessories
at page 230**
/ Scopri gli
accessori della
collezione
Memory a
pagina 230

Sen

Taps / Rubinetti



Sen, "line" in the Japanese language. A combination of Eastern spirit and Western technology, Sen incorporates multiple functions in a line of independent components which can be freely combined to make a distinct style statement, further enhanced by the striking texture of the black brushed aluminium. The wide selection of taps for washbasin, bathtub, shower and sanitary wares is completed by the accessories of the same range.

Sen, "linea" in giapponese. Sintesi di spirito orientale e tecnologia occidentale, Sen integra molteplici funzioni in una linea di elementi indipendenti, liberamente componibili fortemente caratterizzanti, anche grazie alla matericità dell'alluminio spazzolato nero. La famiglia di rubinetti per lavabo, vasca, doccia e sanitari si completa con gli accessori della medesima gamma.

design Gwenaël Nicolas, Curiosity, 2008

Selected "ADI DESIGN INDEX" 2009



Washbasin single hole mixer tap /
Miscelatore lavabo monoforo

Sen

Taps / Rubinetti

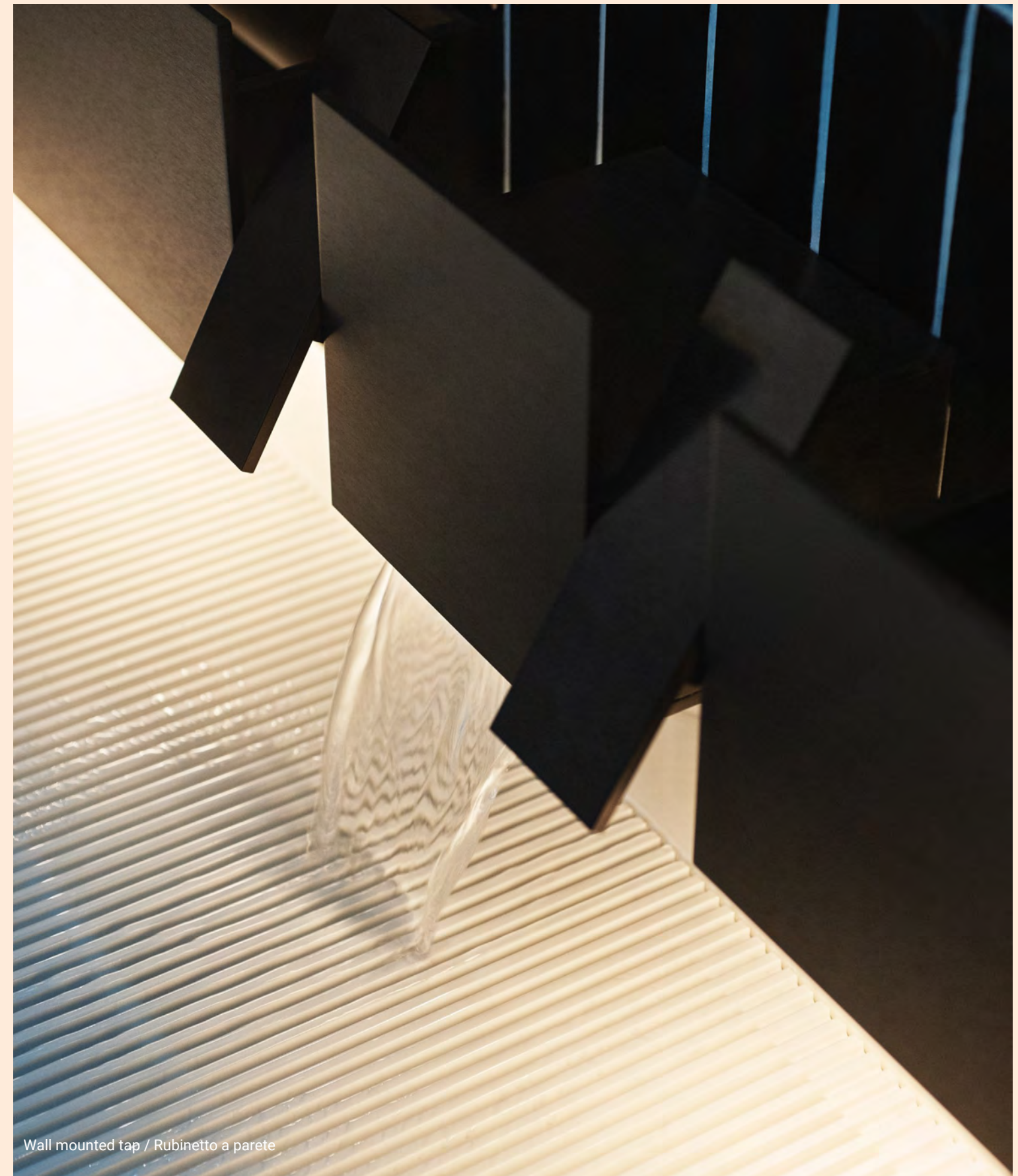

Wall mounted tap / Rubinetto a parete

Sen

Taps / Rubinetti

Wall mounted shower head /
soffione a parete per doccia



Sen

Taps / Rubinetti

Floor standing bathtub mixer tap / Miscelatore per vasca con doccetta
Lariana – bathtub / vasca



Sen

Taps / Rubinetti

**Washbasin,
bidet taps /**
Gruppi lavabo,
bidet

ASEN0910N

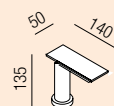

**Single hole mixer tap
for washbasin or bidet /**
Miscelatore lavabo monoforo
per lavabo o bidet

**Washbasin
taps / Gruppi
lavabo**

ASEN0956N

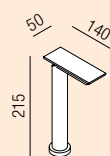

**Single hole mixer tap for
semi-recessed washbasin /**
Miscelatore monoforo per lavabi
a semincasso

ASEN0957N

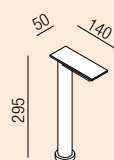

**Single hole mixer tap for
over countertop washbasin /**
Miscelatore monoforo per lavabi
da appoggio

.ESEN0962N+.CRUB0972

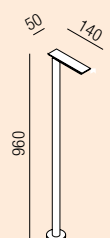

**Floor mounted single hole
lever mixer for washbasin /**
Miscelatore monoforo da terra
per lavabo

.ESEN0912HON+.ISEN09120

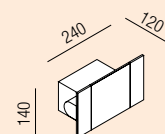

**Wall mounted tap with
horizontal flow for washbasin /**
Rubinetto a parete per lavabo
con erogazione orizzontale

Bathtub taps /
Gruppi vasca

ASEN0973N

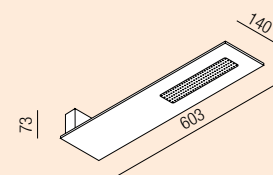

Wall mounted shower head /
Soffione a parete per doccia

.ESEN0942N+.ISEN0942

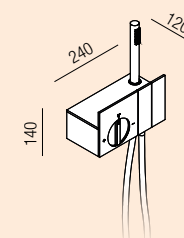

**Wall mounted two-way
thermostatic tap, with hand
shower with flexible hose /**
Rubinetto termostatico a parete
a due vie, con doccetta con tubo
flessibile

**Wc control
plaque / Placca
per controllo
wc**

ASEN0968N

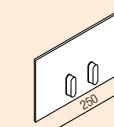

**Control plaque for recessed
flush tank with dual flushing
capacity in brushed anodised
aluminium with black finish /**
Placca comando di risciacquo
per cassetta ad incasso,
con due differenti quantità di
risciacquo

.ESEN0911N+.CRUB0972

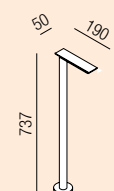

**Floor mounted single hole
mixer for bathtub /** Miscelatore
monoforo da terra per vasca

.ESEN0977N+.ISEN0977

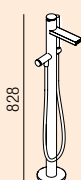

**Floor standing bathtub mixer
tap with hand-held shower, with
floor connections /** Miscelatore
per vasca con doccetta, con
attacchi a pavimento

.ESEN0912VON+.ISEN09120

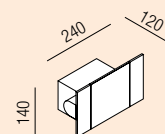

**Wall mounted tap with vertical
flow for bathtub /** Rubinetto a
parete per vasca con erogazione
verticale

**Bathtub,
shower taps /**
Gruppi vasca,
doccia
Sen

Taps / Rubinetti



.ESEN0958N+.ISEN0958

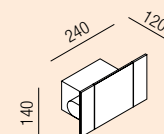

**Wall mounted tap for shower
head control or bathtub tap
spout /** Rubinetto a parete per
comando soffione o per bocca
di erogazione vasca

.ESEN09130N+.ISEN09120

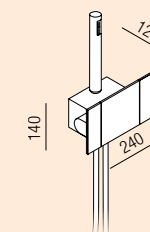

**Wall mounted tap for hand-held
shower with flexible hose /**
Rubinetto a parete per doccetta
con tubo flessibile

Shower taps /
Gruppi doccia

.ESEN09140N+.ISEN09120

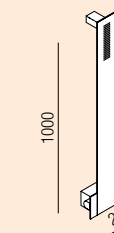

**Wall mounted shower tap with
shower head /** Rubinetto a
parete per doccia con soffione

**Discover the
Sen collection
accessories
at page 236**
/ Scopri gli
accessori della
collezione Sen
a pagina 236

Square

Taps / Rubinetti

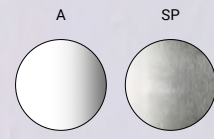

Square is a range that changes the look of tap fittings and enhances them with additional functions, in all types of installation: recessed or surface mounted, for washbasins, bathtubs or showers. Made in polished or satin-finish AISI 316L stainless steel, Square suits every space and situation. Minimal, yet with personality.

Square è un progetto che cambia l'estetica della rubinetteria e la arricchisce di ulteriori funzioni, in tutte le tipologie di installazione: da incasso o esterne, per il lavabo, per la vasca o per la doccia. Realizzata in acciaio inox AISI 316L lucido o satinato, Square si adatta ad ogni spazio e situazione. Minimale ma con personalità.

design Benedini Associati, 2015



Washbasin single hole mixer tap /
Miscelatore lavabo monoforo

Square

Taps / Rubinetti

Built-in washbasin set with single lever joystick mixer tap /
Gruppo lavabo con miscelatore monocomando joystick ad
incasso
Handwash – washbasin / lavabo



Square

Taps / Rubinetti



Washbasin single hole mixer tap /
Miscelatore lavabo monoforo

Square

Taps / Rubinetti

Top mounted washbasin tap /
Gruppo lavabo per piano



Square

Taps / Rubinetti

Joystick mixer for top with wall spout /
Miscelatore joystick per piano con bocca di
erogazione a parete



Square

Taps / Rubinetti

Tap set for bath rim / Gruppo a bordo vasca
DR Cemento – built-in bathtub / vasca ad incasso

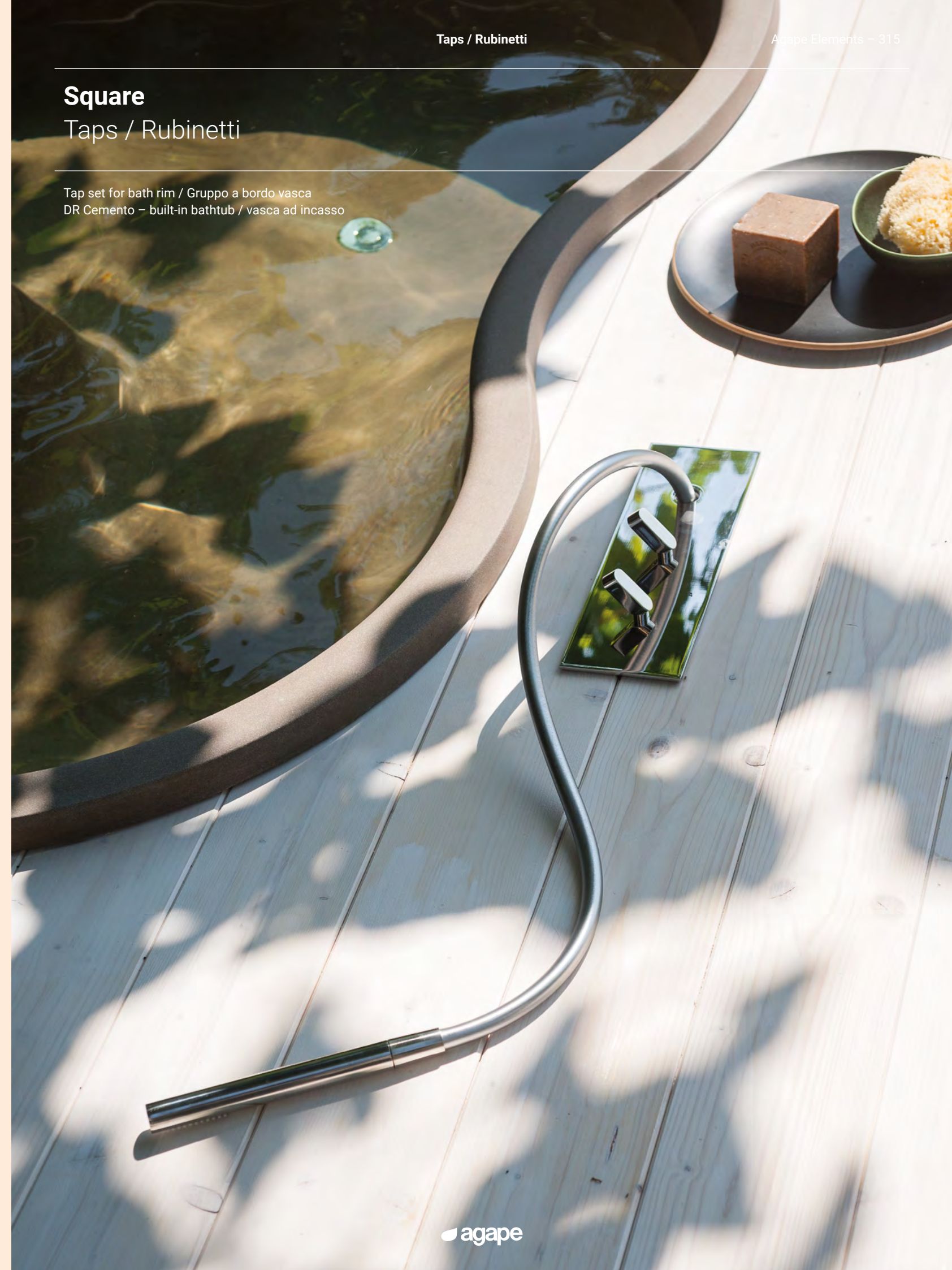

Square

Taps / Rubinetti

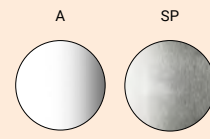

Washbasin taps / Gruppi lavabo

.ERUB1082T_+.IRUB1082T

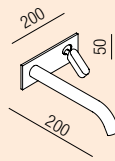

Built-in washbasin set with single lever joystick mixer tap, with horizontal spout (spout 20 cm) / Gruppo lavabo con miscelatore monocomando joystick ad incasso, con bocca orizzontale (bocca cm 20)

.ERUB1116_+.IRUB1082T

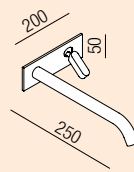

Built-in washbasin set with single lever joystick mixer tap, with horizontal spout (spout 25 cm) / Gruppo lavabo con miscelatore monocomando joystick ad incasso, con bocca orizzontale (bocca cm 25)

ARUB1009T_

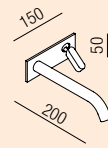

Built-in washbasin set with joystick mixer tap and horizontal spout, to install on Flat XL backsplashes / Gruppo lavabo con miscelatore joystick ad incasso con bocca orizzontale, per installazione su alzate Flat XL

ARUB1083_

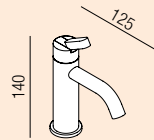

Single hole washbasin mixer tap / Miscelatore lavabo monoforo

ARUB1084_

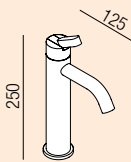

Single hole washbasin mixer tap / Miscelatore lavabo monoforo

ARUB1095_

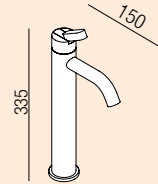

Single hole washbasin mixer tap / Miscelatore lavabo monoforo

ARUB1006_

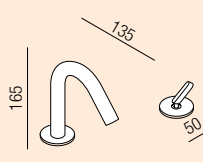

Top mounted washbasin tap set spout and joystick mixer / Gruppo lavabo per piano composto dalla bocca di erogazione e dal miscelatore joystick

ARUB1007_

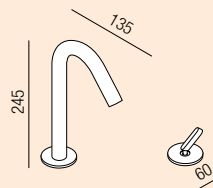

Top mounted washbasin tap set with spout and joystick mixer / Gruppo lavabo per piano composto dalla bocca di erogazione e dal miscelatore joystick

ARUB1008_

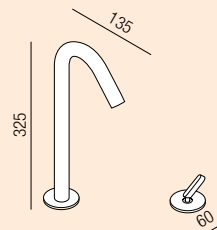

Top mounted washbasin tap set with spout and joystick mixer / Gruppo lavabo per piano composto dalla bocca di erogazione e dal miscelatore joystick

ARUB1081_

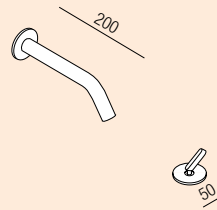

Wall mounted washbasin tap set with spout and joystick mixer / Gruppo lavabo a parete composto dalla bocca di erogazione e dal miscelatore joystick

ARUB1029_



Joystick mixer for top, without spout / Miscelatore joystick per piano, bocca di erogazione esclusa

Square

Taps / Rubinetti

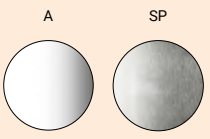

.ERUB1096_+.IRUB1096

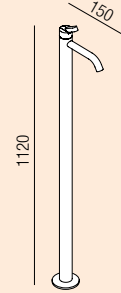

Floor standing washbasin mixer tap with floor connections / Miscelatore lavabo con attacchi a pavimento

Bidet taps / Gruppi bidet

ARUB1097_

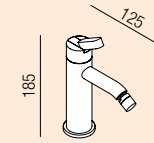

Bidet mixer tap / Miscelatore monoforo bidet

.ERUB1113_+.IRUB1113

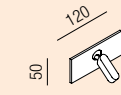

Built-in single lever joystick mixer tap for shower / Miscelatore monocomando joystick ad incasso per doccia

.ERUB1119_+.IRUB1119

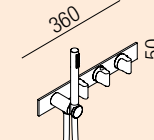

Thermostatic unit for shower with hand-held shower / Gruppo termostatico per doccia completo di doccetta

.ERUB1110_+.IRUB1082T

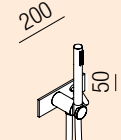

Built-in single lever joystick mixer tap with hand-held shower / Miscelatore monocomando joystick ad incasso completo di doccetta

Bathtub taps / Gruppi vasca

.ERUB1117_+.IRUB1117

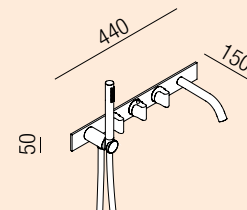

Thermostatic unit for bathtub with hand-held shower (spout 15 cm) / Gruppo termostatico per vasca completo di doccetta (bocca cm 15)

.ERUB1118_+.IRUB1117

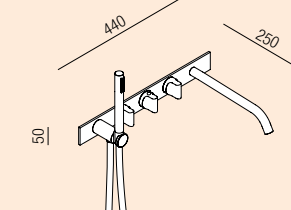

Thermostatic unit for bathtub with hand-held shower (spout 25 cm) / Gruppo termostatico per vasca completo di doccetta (bocca cm 25)

.ERUB1112_+.IRUB1112

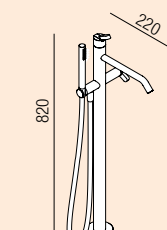

Floor standing bathtub mixer tap with hand-held shower, with floor connections / Miscelatore per vasca con doccetta, con attacchi a pavimento

.ERUB1115_+.IRUB1112

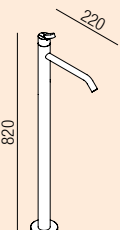

Floor standing bathtub mixer tap with floor connections / Miscelatore per vasca con attacchi a pavimento

Square

Taps / Rubinetti

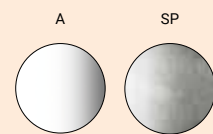

ARUB0960_

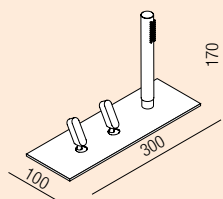

Tap set for bath rim with gradual control, single lever mixer tap and built-in hand-held shower / Gruppo a bordo vasca, con miscelatore monocomando progressivo e doccetta ad incasso

.CRUB1180_

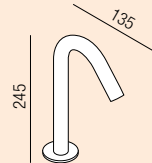

Tap spout for bathtub's edge / Bocca di erogazione per bordo vasca

Wc control plaque / Placca per controllo WC

ARUB0968N_

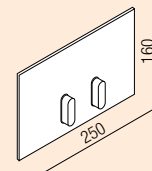

Control plaque for recessed flush tank; available in stainless steel / Placca comando di risciacquo per cassetta ad incasso, in acciaio inox.

Square

Freestanding shower / Doccia freestanding

Square changes the look of tap fittings and enhances them with additional functions, in all types of installation: recessed or external, for washbasins, bathtubs or showers. The collection, technically and aesthetically revisited in 2015, is now completed by a freestanding shower. Square is made in AISI 316L stainless steel (polished or satin-finish).

Square è un progetto che cambia l'estetica della rubinetteria e la arricchisce di ulteriori funzioni, in tutte le tipologie di installazione: da incasso o esterne, per il lavabo, per la vasca o per la doccia. La collezione, sottoposta ad una profonda revisione tecnica ed estetica nel 2015, si completa con un soffione da terra per doccia. Square è realizzata in acciaio inox AISI 316L (lucido o satinato).

.ERUB1121_+.IRUB1121

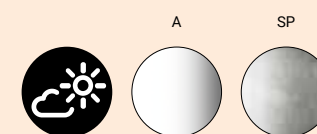
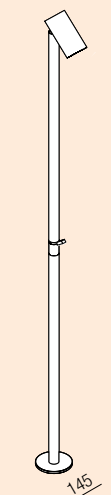

design Benedini Associati, 2015 / 2020



Square

Freestanding shower / Doccia freestanding



Shower heads and handheld showers / Soffioni e doccette

Shower heads, handheld showers, hydrobrushes and other tapware accessories in different materials and dimensions: studied solutions to complete the wide Agape taps range.

Soffioni, doccette, idroscopini e supporti in vari materiali e dimensioni: le soluzioni studiate per completare l'ampia gamma di rubinetteria Agape.



		shower heads / soffioni	handhelds shower / doccette	for wc / per wc	for bidet / per bidet
Flat D	p. 327	●			
Flat DX	p. 328	●			
Hydro	p. 324			●	●
Kaa	p. 325	☀	☀		
Open Air	p. 323	☀			
Square	p. 329	☀			



Items marked with this symbol are part of the Outdoor Collection and can also be used outdoors / Gli articoli contrassegnati con questo simbolo fanno parte della Collezione Outdoor e possono essere utilizzati anche all'esterno

Open Air

Freestanding shower / Doccia freestanding

Freestanding shower with support in black anodized aluminum and basement in dark grey Cementoskin® (coloured concrete paste). Water adduction elements are realized in POM, plastic material in black finish. The flexible hose, in black PVC, is completed with rapid garden connection. The shower only foresees the flow regulation.

Doccia da terra con supporto in alluminio anodizzato nero e base in Cementoskin® (cemento colorato in pasta) grigio scuro; gli elementi di adduzione dell'acqua sono realizzati in POM, materiale plastico, con finitura nera. Il tubo flessibile, in PVC nero, è completo di attacco rapido per giardino. La doccia è dotata di sola regolazione di flusso.

☀ **ADOC1631**

● Flexible hose in black PVC /
Tubo in PVC nero



● Black anodized aluminium
support / Supporto in alluminio
anodizzato nero

● Cementoskin® base /
Base in Cementoskin®

Winner "ARCHIPRODUCTS DESIGN AWARD" 2020
Selected "ADI DESIGN INDEX" 2021



design Benedini Associati, 2019



Hydro

Hydrobrush and hydrobidet / Idroscopino e idrobidet

Orange, green or chromed plastic hydrobrush (Idroscopino®) for WC cleaning and hydrobidet for the personal hygiene with flexible hose in stainless steel mesh, with a transparent PVC cover produced in collaboration with ARVAG. Water connection and wall mounted holder in polished chromed brass. Temperature regulation not managed.

Idroscopino® per la pulizia del WC e Idrobidet per l'igiene personale in materiale plastico arancio, verde o cromo, tubo flessibile con treccia in acciaio inox e rivestimento in PVC trasparente; realizzato in collaborazione con ARVAG. Presa d'acqua e supporto a parete in ottone cromato lucido. Regolazione di temperatura non gestita.

ARUB0918_

ARUB0916_

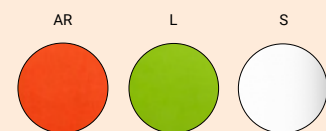
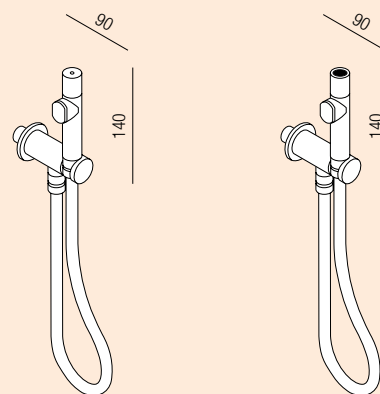

design Giulio Gianturco, RD Agape, 2006



Kaa

Handheld shower and shower head / Doccetta e soffione

The flexible handheld shower head, made of hypo-allergenic silicone rubber, offer a gentle massage for the body. It can be combined with the shower head, both available in orange and in two shades of grey to brighten up shower taps and fittings. Patented product.

*** the dark grey finish may have slightly darker streaks, however they are an intrinsic feature of the material and do not compromise the functionality of the item**

Winner "EDIDA" 2005
Winner "DESIGN PLUS MATERIAL VISION" 2005
Winner "GERMAN DESIGNPREIS" 2007

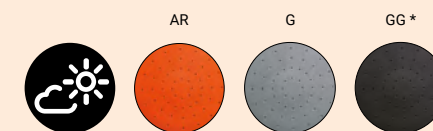

L'elasticità della doccetta realizzata con gomma siliconica anallergica, trasmette la morbidezza del massaggio per la cura della persona. Abbinabile al soffione, entrambi disponibili in arancio e in due tonalità di grigio, donano colore alla rubinetteria della doccia. Prodotto brevettato.

* la finitura grigio scuro può presentare aloni leggermente più scuri che non compromettono la funzionalità dell'articolo

☀ .CRUB0913_

ø 180



☀ .CRUB0914_

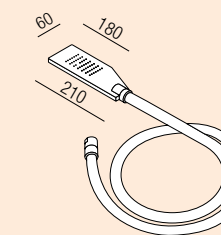

design Giulio Gianturco, RD Agape, 2003

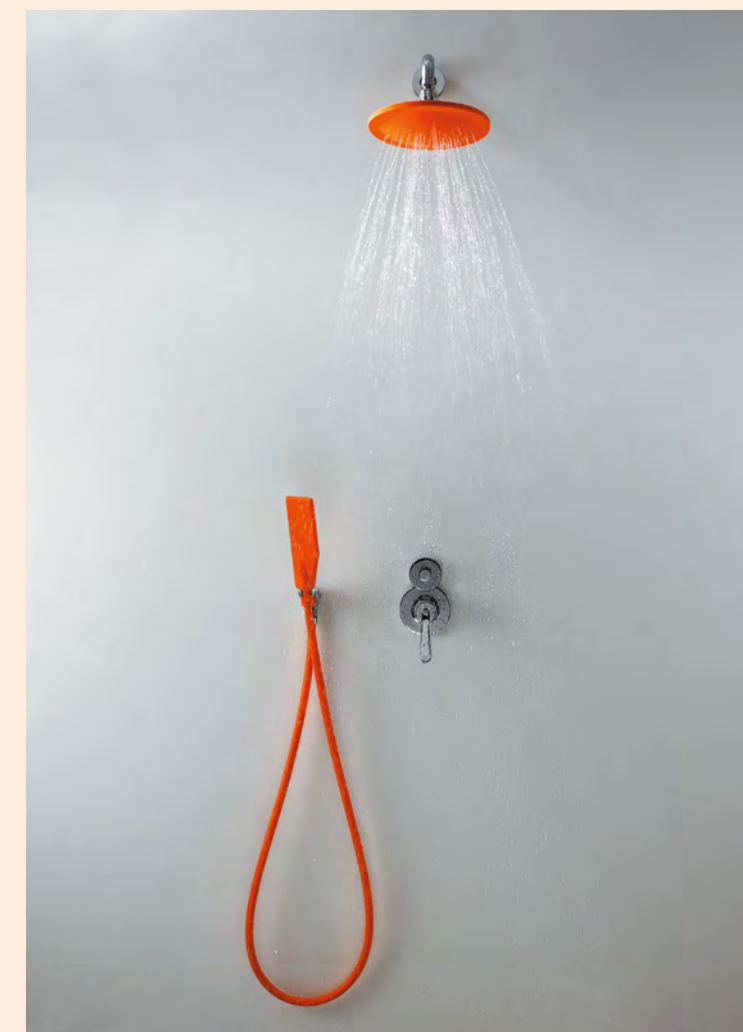

Kaa + Flat D

Shower head / Soffione



Flat D

Shower head / Soffione



Flat D - shower head / soffione
Flat D - shower / doccia
Sen - taps / rubinetteria
Sen - accessories / accessori

Flat DX

Shower head / Soffione



design Benedini Associati, 2002

Square

Shower head / Soffione



design Benedini Associati, 2015

Shower heads and handheld shower Soffioni e doccette

.CRUB1103R_

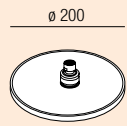

Limescale resistant shower head in ABS (ø 200 mm) / Soffione anticalcare in ABS (ø 200 mm)

.CRUB1109R_

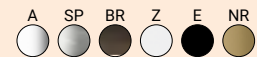
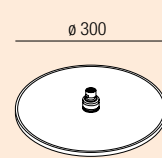

Limescale resistant shower head in stainless steel (ø 300 mm - 11" 7/8) / Soffione anticalcare in acciaio inox (ø 300 mm) per Fez 2, Memory, Sen e Square

.CRUB1165_

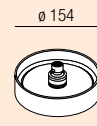

Cylindrical limescale resistant shower head in stainless steel (ø 154 mm) / Soffione anticalcare in acciaio inox cilindrico (ø 154 mm)

.CRUB0913_

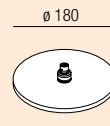

Shower head Kaa (ø 180 mm) in non-allergenic silicone rubber, with articulated joint / Soffione Kaa (ø 180 mm) realizzato in gomma silconica analergica, completo di snodo

.CRUB1160

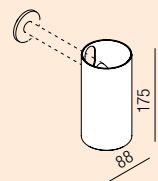

Anti-limescale shower head in stainless steel (ø 88 mm) / Soffione anticalcare in acciaio inox (ø 88 mm)

.CRUB1161

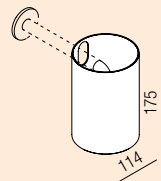

Anti-limescale shower head in stainless steel (ø 114 mm) / Soffione anticalcare in acciaio inox (ø 114 mm)

.CRUB1162

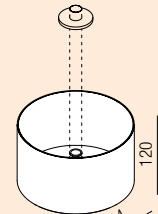

Anti-limescale shower head in stainless steel (ø 204 mm) / Soffione anticalcare in acciaio inox (ø 204 mm)

.CRUB0926_

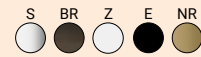
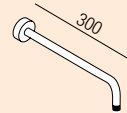

Wall mounted brass shower head support / Supporto a parete in ottone, per soffione

.CRUB0927_

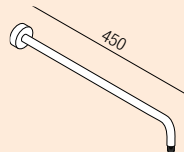

Wall mounted brass shower head support / Supporto a parete in ottone per soffione

.CRUB1163

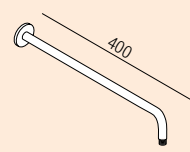

Wall bracket in stainless steel for shower head, joint excluded / Supporto a parete in acciaio inox per soffione, snodo escluso

.CRUB1170

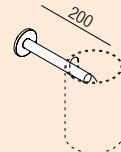

Wall bracket in stainless steel for shower head .CRUB1160 and .CRUB1161, joint excluded / Supporto a parete in acciaio inox per soffione .CRUB1160 e .CRUB1161, snodo escluso

.CRUB1171

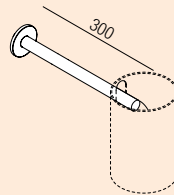

Wall bracket in stainless steel for shower heads .CRUB1160 and .CRUB1161, joint excluded / Supporto a parete in acciaio inox per soffione .CRUB1160 e .CRUB1161, snodo escluso

Shower heads and handheld shower Soffioni e doccette

.CRUB1172

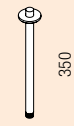

Ceiling bracket in stainless steel for shower head, joint excluded / Supporto a soffitto in acciaio inox per soffione, snodo escluso

.CRUB1173



Ceiling bracket in stainless steel for shower head, joint excluded / Supporto a soffitto in acciaio inox per soffione, snodo escluso

.CRUB0931



Ceiling bracket in brass for shower head, joint excluded / Supporto a soffitto in ottone per soffione, snodo escluso

.CRUB0932



Ceiling bracket in sbrass for shower head, joint excluded / Supporto a soffitto in ottone per soffione, snodo escluso

.CRUB1152_



Handheld shower support in stainless steel, with water mains connection / Supporto per doccetta in acciaio inox, con presa d'acqua

.MET0169R_

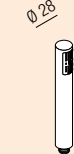

Cylindrical limescale resistant handheld shower in brass with non return valve / Doccetta anticalcare cilindrica in ottone con valvola di non ritorno

.CRUB0914_

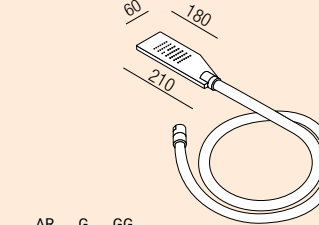

Kaa handheld shower with hose (150 cm hose - 1/2" G) in non-allergenic silicone rubber / Doccetta Kaa con tubo (tubo cm 150 - 1/2" G) in gomma silconica analergica

.MET0268R_

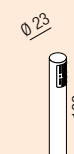

Cylindrical limescale resistant handheld shower in ABS with non-return valve / Doccetta anticalcare cilindrica in ABS con valvola di non ritorno

.CRUB1102R_



Cylindrical limescale resistant handheld shower in ABS with non-return valve / Doccetta anticalcare in ABS con valvola di non ritorno

ARUBL_

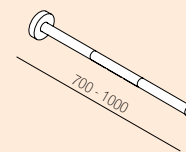

Flat D linear element with three diffusers for showers with external profiles / Flat D elemento lineare con tre diffusori per docce con profili esterni

ARUBS_

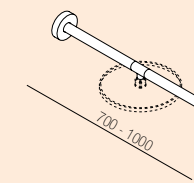

Flat D linear element with shower head connection for showers with external profiles, made of chrome plated brass / Flat D elemento lineare con attacco per soffione per docce con profili esterni, realizzato in ottone cromato

AXRUBL_

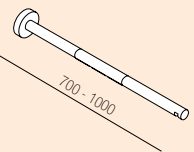

Flat DX linear element with three diffusers for showers with external profiles / Flat DX elemento lineare con tre diffusori per docce con profili esterni

Shower heads and handheld shower Soffioni e doccette

AXRUBS_

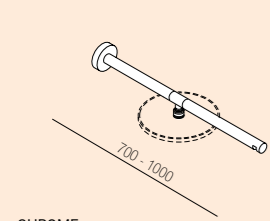

CHROME

Flat DX linear element with shower head connection for showers with external profiles, made of chrome plated brass / Flat DX elemento lineare con attacco per soffione per docce con profili esterni, realizzato in ottone cromato

ASEN0914N

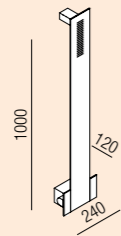

N

Sen wall mounted shower tap with shower head / Rubinetto Sen a parete per doccia con soffione

ASEN0973N

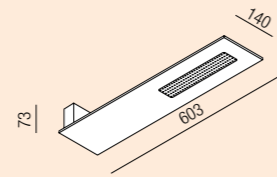

N

Sen wall mounted shower head in brushed anodised aluminium with black finish / Soffione Sen a parete per doccia realizzato in alluminio anodizzato spazzolato con finitura nera

Mirrors and mirror cabinets / Specchi e specchi contenitori

Agape mirrors are furnishing and architectural components in their own right, ideal for adding light and spaciousness to their surroundings. They often also offer special features for an even clearer view: from integrated lighting to magnifying or doublesided mirrors. Agape offers a wide choice of mirror units: more than just a simple detail in the bathroom.

Gli specchi Agape sono degli autentici elementi d'arredo e d'architettura, ideali per aggiungere luce e spaziosità all'ambiente. Inoltre offrono spesso soluzioni speciali per una visione ancora migliore: dall'illuminazione integrata, agli specchi ingranditori o bifacciali. Agape offre una scelta completa di specchi contenitori: più di un semplice dettaglio nella stanza da bagno.

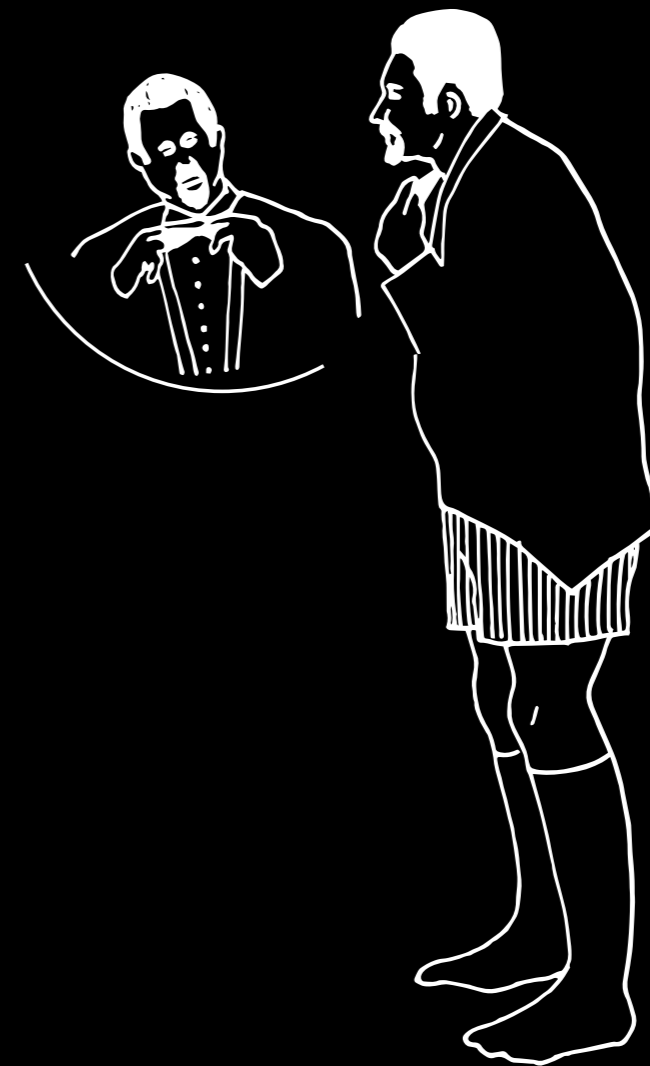

	with light / con luce	without light / senza luce	with cabinet / con contenitore	over countertop / da appoggio
027			p. 335	
4x4			p. 336	
Bucatini	p. 339	p. 339		
Constellation				p. 340
Dot Line		p. 341		
Eclissi	p. 342			
Fusilli		p. 344		p. 344
Gabbiano		p. 345		
Insegna		p. 346		
Lift			p. 348	
Memory	p. 350	p. 350		
Minuetto		p. 353		
Narciso	p. 354	p. 354		
Nudo		p. 358		
Nudo LED	p. 359			
Revolving Moon		p. 360		
Seppia	p. 361	p. 361		
Solid	p. 362			
Spai		p. 364		
Spin		p. 365		
Vitruvio		p. 366		

027

Mirror cabinet / Specchio contenitore

The sliding door gives easy access to the polished or satin-finish stainless steel shelves inside this wall mounted mirror cabinet in birch plywood with finish in natural, brown or dark oak veneer or in reconstituted wood, teak finish.

L'anta scorrevole a specchio rende accessibili, con un semplice gesto, i ripiani interni in acciaio inox lucido o satinato di questo specchio contenitore pensile in multistato di betulla con finitura rovere naturale, bruno, scuro o in legno precomposto con finitura teak.

AMOB027HL
L min 1206 mm
L max 2406 mm

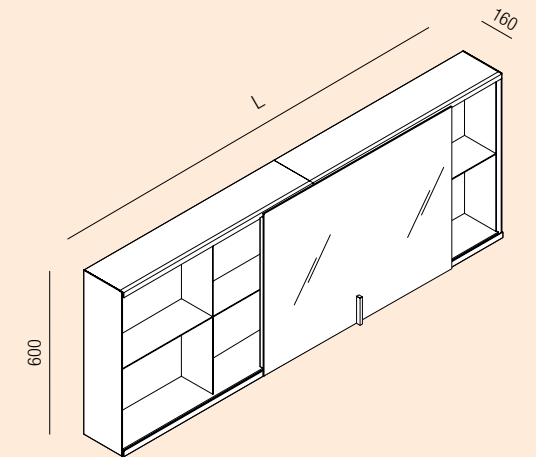

design Benedini Associati, 2002



4x4

Mirror cabinets / Specchi contenitori

A wide choice of positions and uses for these storage units in aluminium with a white or black painted finish.

Fitted with a double-sided mirror door.

Molteplici possibilità di collocazione ed utilizzo, per questi contenitori in alluminio verniciato bianco o nero.

Dotati di anta a specchio bifacciale.

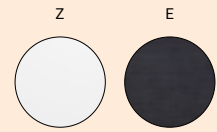

design Benedini Associati, 2003

**4x4**

Mirror cabinets / Specchi contenitori

4x4 – mirror cabinets / specchi contenitori
Fez 2 – taps / rubinetteria



4x4

Mirror cabinets / Specchi contenitori

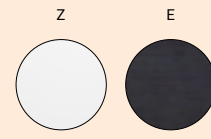

A4X4289_

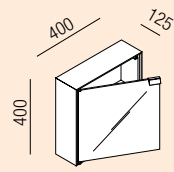

Cabinet cm 40x40 H, with 1 internal shelf / Contenitore cm 40x40 H, con 1 ripiano interno

A4X4292_

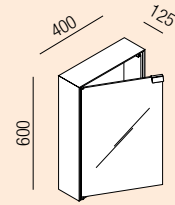

Cabinet cm 40x60 H, with 2 internal shelves / Contenitore cm 40x60 H, con 2 ripiani interni

A4X4290_

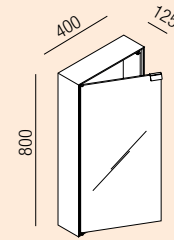

Cabinet cm 40x80 H, with 2 internal shelves / Contenitore cm 40x80 H, con 2 ripiani interni

A4X4291_

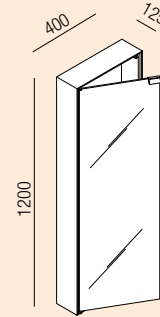

Cabinet cm 40x120 H, with 3 internal shelves / Contenitore cm 40x120 H, con 3 ripiani interni

A4X4293_

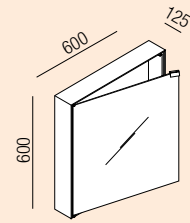

Cabinet cm 60x60 H, with 2 internal shelves / Contenitore cm 60x60 H, con 2 ripiani interni

A4X4290H_

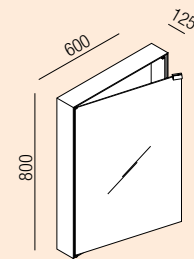

Cabinet cm 60x80 H, with 2 internal shelves / Contenitore cm 60x80 H, con 2 ripiani interni

A4X4291H_

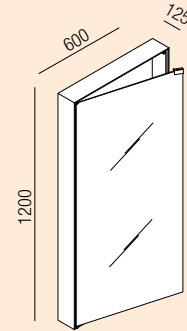

Cabinet cm 60x120 H, with 3 internal shelves / Contenitore cm 60x120 H, con 3 ripiani interni

Bucatini

Mirrors / Specchi

Bucatini is the ultimate essential mirror, available in two different versions: one supported by a wire cable on the wall, the other a simple, circular mirror; also available with or without rear LED lighting. The code item ABUC178LU is certified for US market.

Lo specchio Bucatini, ovvero il massimo dell'essenzialità in due versioni diverse: una sorretta da cavo metallico a parete, l'altra un semplice specchio circolare, in versione con illuminazione a LED posteriore o senza luce. L'articolo ABUC0178LU è certificato per mercato Usa.

ABUC0178L
ABUC0178LU
ABUC0178N

ABUC0178_

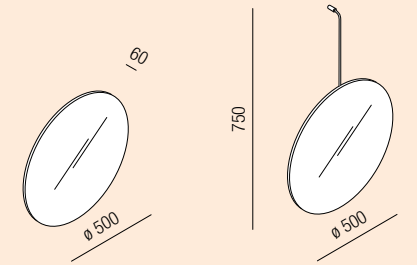

Fixing finish / Finitura fissaggi

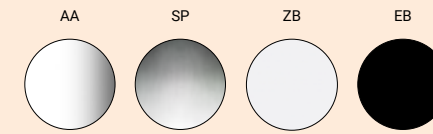

Cable finish / Finitura cavetto

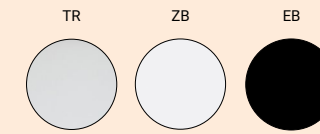

design Ermanno Righi, Fabio Bortolani, 1997



Constellation

Tabletop mirrors / Specchi da tavolo

Tabletop horizontal or vertical mirror with base in white Carrara or black Marquina marble. The details are in natural brushed brass. They inject an eye-catching and functional look to any bathroom, when placed near the bathtub or on a container, but they are also perfect in other parts of the home, when gracing a desk or bookcase.

Specchi da tavolo orizzontali o verticali con base in marmo bianco di Carrara o nero Marquina. I dettagli che caratterizzano gli oggetti sono realizzati in ottone naturale spazzolato. Trovano la loro collocazione estetica e funzionale sia nel bagno – vicino alla vasca o su un contenitore – sia negli altri ambiti del paesaggio domestico, come su una scrivania o una libreria.

ACOM0301_

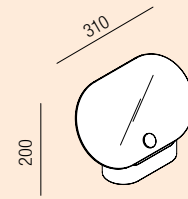

ACOM0300_

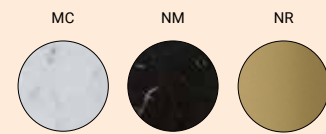
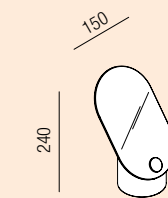

design Studioepepe, 2018



Dot Line

Mirrors / Specchi

The Dot Line accessories set is complemented by mirrors whose design recaptures the stylistic theme of lines and points. The characterizing feature is the support that comes in black anodized aluminum or natural, brown or dark oak finish.

La famiglia degli accessori Dot Line è completata da specchi il cui design riprende il tema stilistico della linea e del punto. L'elemento caratterizzante è il sostegno che può essere in alluminio anodizzato nero o con rivestimento in rovere naturale, bruno o scuro.

ADTL0459_

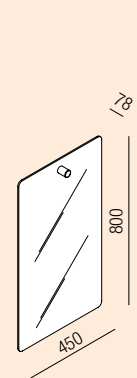

ADTL0472_

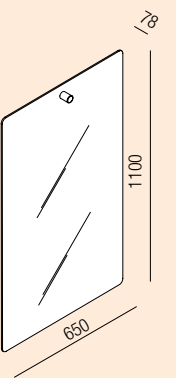

design García Cumini, 2016



Eclissi

Mirror / Specchio

Two mirrors and as many reading layers. Two depths and two diameters, 70 and 50 cm, which are compared by proximity and relative position. The soft edges of their luminous halo generate surprising contrasts with the elementary geometry of the reflecting surfaces, defined only by the thin sign of the light that reverberates on the perimeter. 0.6 square meters of reflection in timid overlap. The 50 cm element orbits around the larger mirror to adapt to different functional needs (for example two people with different heights) and aesthetic needs. ASPE038U is certified for US market.

Due specchi e altrettanti piani di lettura. Due profondità e due diametri, cm 70 e 50 che si confrontano per prossimità e posizione relativa. I contorni sfumati del loro alone luminoso generano sorprendenti contrasti con la geometria elementare delle superfici riflettenti, definiti tra loro solo dal sottile segno della luce che riverbera sul perimetro. 0,6 metri quadri di riflessione in timida sovrapposizione. L'elemento da cm 50 orbita attorno allo specchio più grande per adattarsi alle diverse esigenze funzionali (ad esempio due persone con altezze diverse) ed estetiche. L'articolo ASPE038U è certificato per mercato USA.

ASPE038
ASPE038U

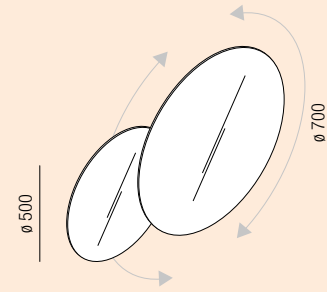

design Gergely Ágoston, RD Agape, 2016



Eclissi

Mirror / Specchio

Bjhn 1 – washbasin / lavabo
Flat XL – countertop / piano
Eclissi – mirror / specchio
Sen – taps / rubinetteria
Sen – accessories / accessori
Surf – accessories / accessori



Fusilli

Mirrors / Specchi

The chrome-plated double flexible support allows Fusilli to be positioned at any angle. The mirror is double-sided, with one magnifying surface. Numerous installation options are available: on the wall, on a countertop, or freestanding, using a square white Carrara marble base, which adds a distinguished air.

Fusilli è orientabile in infinite direzioni grazie al doppio supporto flessibile cromato. Lo specchio è bifacciale con un lato ingranditore. Molteplici le possibilità di installazione: a parete, su piano, oppure in appoggio grazie alla base quadrata in marmo bianco di Carrara dalla presenza importante.

ASPE012L

ASPE012P

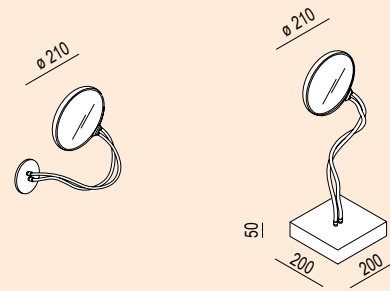

design Benedini Associati, 1997



Gabbiano

Mirror / Specchio

Designed in 1994 by Giuseppe Pasquali, Gabbiano represents one of the Agape iconic products. Its shape recalls its name: a fixed central part and two lateral and adjustable "wings" that lighten its design while ensuring extreme functionality. All enclosed in an elegant polished stainless steel frame.

Disegnato nel 1994 da Giuseppe Pasquali, Gabbiano rappresenta uno dei prodotti icona per Agape. La sua forma ne richiama il nome: una parte centrale fissa e due "ali" laterali e orientabili che alleggeriscono il suo disegno garantendo allo stesso tempo estrema funzionalità. Il tutto racchiuso da un elegante telaio in acciaio inox lucidato.

AGAB0351

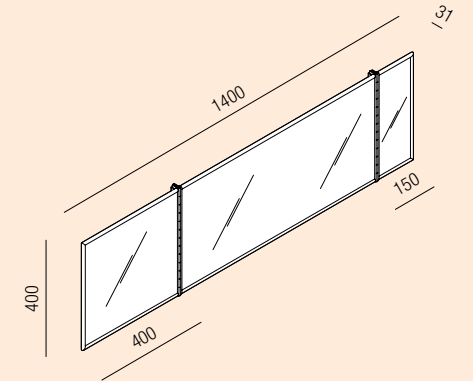

design Giuseppe Pasquali, 1994



Insegna

Mirror / Specchio

Double-sided rectangular mirror suspended from the ceiling with steel cables to be installed in any environment. Height 40 cm, width from 80 to 180 cm with modules of 20 cm; possibility of measures on customer's request.

Specchio rettangolare bifacciale sospeso a soffitto con cavi in acciaio per essere installato in ogni ambiente. Altezza 40 cm, larghezza da 80 a 180 cm con moduli da 20 cm; possibilità di misure su richiesta del cliente.

ASPE015 – L cm 80 **ASPE017** – L cm 140
ASPE023 – L cm 100 **ASPE018** – L cm 160
ASPE016 – L cm 120 **ASPE019** – L cm 180

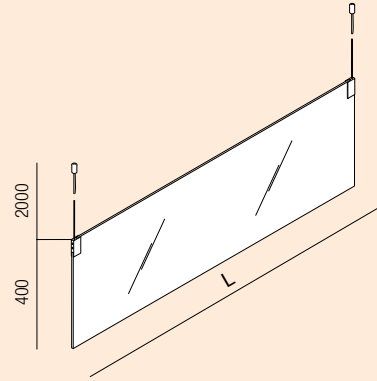

design Benedini Associati, 2000



Insegna

Mirror / Specchio



Lariana – washbasin / lavabo
 Rigo – system / sistema
 Insegna – mirror / specchio
 Fez 2 – taps / rubinetteria
 Fusilli – mirror / specchio

Lift

Mirror cabinets / Specchi contenitori

Lift is a range of wall-mounted and modular mirrors cabinet that allow you to organize and furnish the environment, ranging vertically and horizontally, to create the most diverse solutions, ideally combined with Flat XL, Evoluzione and Lato systems.

Lift containers can be requested, when ordering, complete with electrified bar on which to attach various types of adapters for connecting electrical appliances.

Lift è un programma di specchi contenitori pensili e modulari che consentono di organizzare e arredare l'ambiente, spaziando in verticale e in orizzontale, per creare le più diverse soluzioni, in ideale abbinamento con i sistemi Flat XL, Evoluzione e Lato.

I contenitori Lift possono essere richiesti, in fase di ordine, completi di barra elettrificata sulla quale agganciare vari tipi di adattatori per il collegamento di apparecchi elettrici.

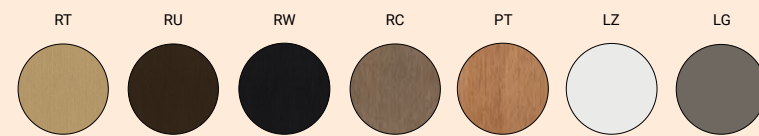

design Benedini Associati, 2018



Lift

Mirror cabinets / Specchi contenitori

AMOB051H_

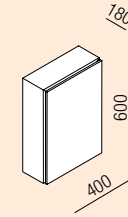

Container with door, height
60 cm / Contenitore con anta,
altezza 60 cm

AMOB052H_

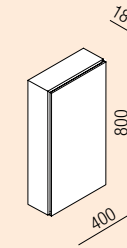

Container with door, height
80 cm / Contenitore con anta,
altezza 80 cm

AMOB053H_

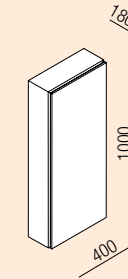

Container with door, height
100 cm / Contenitore con anta,
altezza 100 cm

AMOB054H_

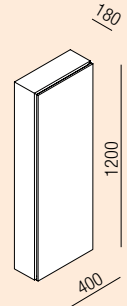

Container with door, height
120 cm / Contenitore con anta,
altezza 120 cm

Case, 18 cm deep and 40 cm wide, in four heights: 60, 80, 100 and 120 cm / Cassa con profondità cm 18 e larghezza cm 40, realizzata in quattro altezze: 60, 80, 100 e 120 cm

Finish of casing / Finitura cassa



The Lift mirror units can be requested complete with electrified bar with possibility to install various types of adapters to connect electrical devices (.ELE257E) / Gli specchi contenitori Lift possono essere richiesti completi di barra elettrificata sulla quale agganciare vari tipi di adattatori per il collegamento di apparecchi elettrici (.ELE257E)

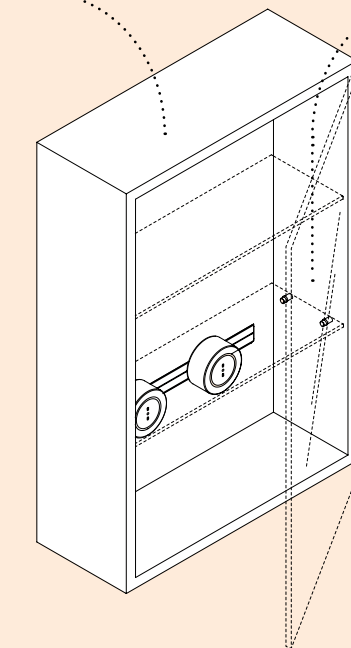

The hinged door, with opening on the right or on the left is equipped with amortized hinges with push-pull or traditional opening / L'anta a battente, con apertura a destra o a sinistra è dotata di cerniere ammortizzate con apertura push-pull o tradizionale

Finish of front / Finitura anta



The storage units can be combined both vertically and horizontally / I contenitori possono essere affiancati sia in verticale che in orizzontale

Discover the Lift collection storage units at page 384 / Scopri i contenitori della collezione Lift a pagina 384

.ELE253



Adapter Italy ITA4 / Adattatore Italia ITA4

.ELE258



Adapter Schuko GS4 / Adattatore Schuko GS4

.ELE255



Adapter Great Britain BS4 / Adattatore Gran Bretagna BS4

.ELE256



Adapter France FR4 / Adattatore Francia FR4

Memory

Mirrors / Specchi

Memory is a round or square mirror with rounded corners, surrounded or not by a white or black lacquered frame, available also with LED lighting positioned behind the reflective glass. Items identified with a final 'U' code are available for the US market.

Di forma tonda o rettangolare con spigoli arrotondati, circondato o meno da cornice laccata bianca o nera, lo specchio Memory è disponibile anche dotato di illuminazione a LED posta dietro la superficie riflettente. Gli articoli identificati con codice 'U' finale sono disponibili per il mercato USA.

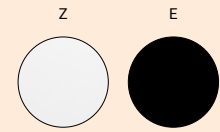

design Benedini Associati, 2010



Memory

Mirrors / Specchi

Immersion – washbasin / lavabo
 Memory – mirror / specchio
 Sen – taps / rubinetteria
 Sen – accessories / accessori
 Dot Line – accessories / accessori



Memory

Mirrors / Specchi

AMEM863_L / AMEM863_LU

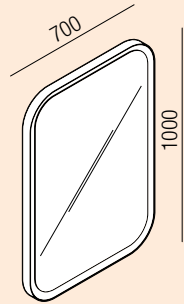

Mirror with painted frame and internal LED lighting / Specchio con cornice laccata e illuminazione interna a LED

AMEM863_

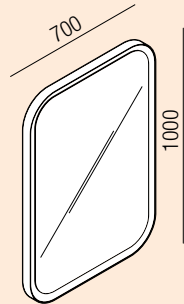

Mirror with painted frame without lighting system / Specchio con cornice laccata senza illuminazione

AMEM863L / AMEM863LU

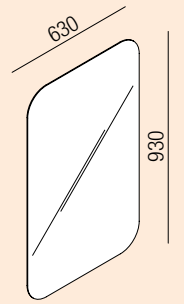

Mirror without frame with polished edge and LED lighting / Specchio senza cornice con bordo a filo lucido e illuminazione a LED

AMEM863N

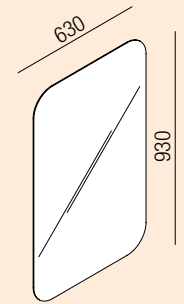

Mirror without frame with polished edge, without lighting system / Specchio senza cornice con bordo a filo lucido senza illuminazione

AMEM867_L / AMEM867_LU

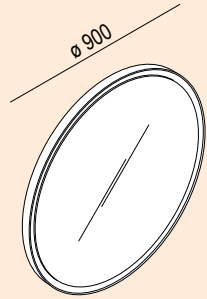

Mirror with painted frame and internal LED lighting / Specchio con cornice laccata e illuminazione interna a LED

AMEM867_

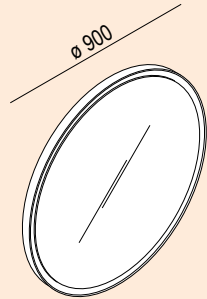

Mirror with painted frame without lighting system / Specchio con cornice laccata senza illuminazione

AMEM867NL / AMEM867NLU

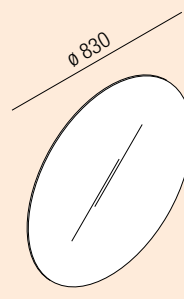

Mirror without frame with polished edge and LED lighting / Specchio senza cornice con bordo a filo lucido e illuminazione a LED

AMEM867N

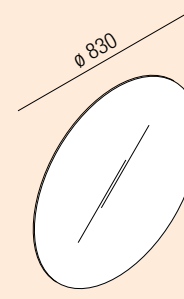

Mirror without frame with polished edge, without lighting system / Specchio senza cornice con bordo a filo lucido senza illuminazione

AMEM866_L / AMEM866_LU

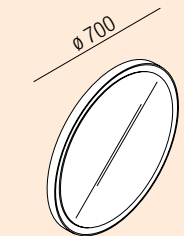

Mirror with painted frame and internal LED lighting / Specchio con cornice laccata e illuminazione interna a LED

AMEM866_

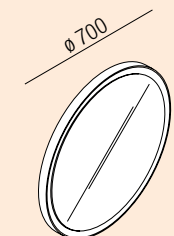

Mirror with painted frame without lighting system / Specchio con cornice laccata senza illuminazione

AMEM866NL / AMEM866NLU

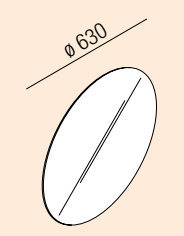

Mirror without frame with polished edge and LED lighting / Specchio senza cornice con bordo a filo lucido e illuminazione a LED

AMEM866N

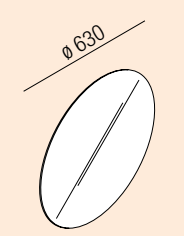

Mirror without frame with polished edge, without lighting system / Specchio senza cornice con bordo a filo lucido senza illuminazione

Minuetto

Mirror / Specchio

Rectangular mirror with polished edge, and back panel in white solid surface, with safety film, suspended from the ceiling by means of stainless steel cables and supports. The mirror is fixed to the ceiling by means of screws and wall plugs.

Specchio rettangolare con bordo a filo lucido, e parte posteriore in solid surface bianco, sospeso a soffitto con cavi e supporti in acciaio inox. Lo specchio è fissato a soffitto con viti e tasselli ad espansione.

AMIN0302

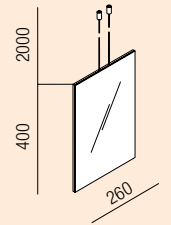

design Benedini Associati, 2000



Narciso

Mirror / Specchio

Dedicated to those who want to take care of themselves in more than one way, Narciso is a mirror split into one, large, central and two, double-sided, pivoting side panels, supported by exposed, chromed brass hinges. The simplicity and expressive impact of the Narciso mirror are further emphasized by the backlighting system that gives it extra prominence on the wall, creating a play of reflections, light and shadows.

Dedicato a chi vuole prendersi cura di sé da ogni punto di vista, Narciso è uno specchio suddiviso in un grande elemento centrale e in due elementi laterali bifacciali orientabili, sostenuti da cerniere in ottone cromato a vista. L'essenzialità e la forza espressiva dello specchio Narciso vengono messe ancora più in evidenza dal sistema di retroilluminazione che lo fa spiccare sulla parete, creando giochi di riflessi, luci ed ombre.

The item is developed in several variants, the codes relating to the multiple dimensions are available on the price list /

L'articolo si sviluppa in più varianti, i codici relativi alle molteplici dimensioni sono disponibili sul listino

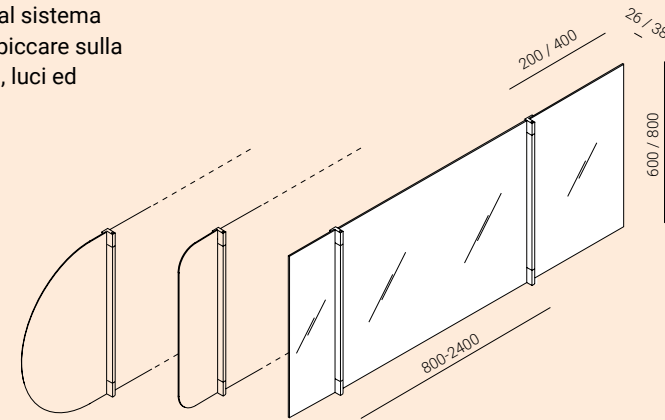

design Benedini Associati, 2003



Narciso

Mirror / Specchio

Ell – washbasin-countertop / piano lavabo

Lato – storage unit / contenitore

Narciso – mirror / specchio

Memory – taps / rubinetteria

Dot Line – accessories / accessori



Narciso

Mirror / Specchio

**Narciso**

Mirror / Specchio

L – min 800 mm / max 2400 mm

H – 600 mm / 800 mm

S – 26 mm, without light / senza luce

S – 38 mm, with light / con luce

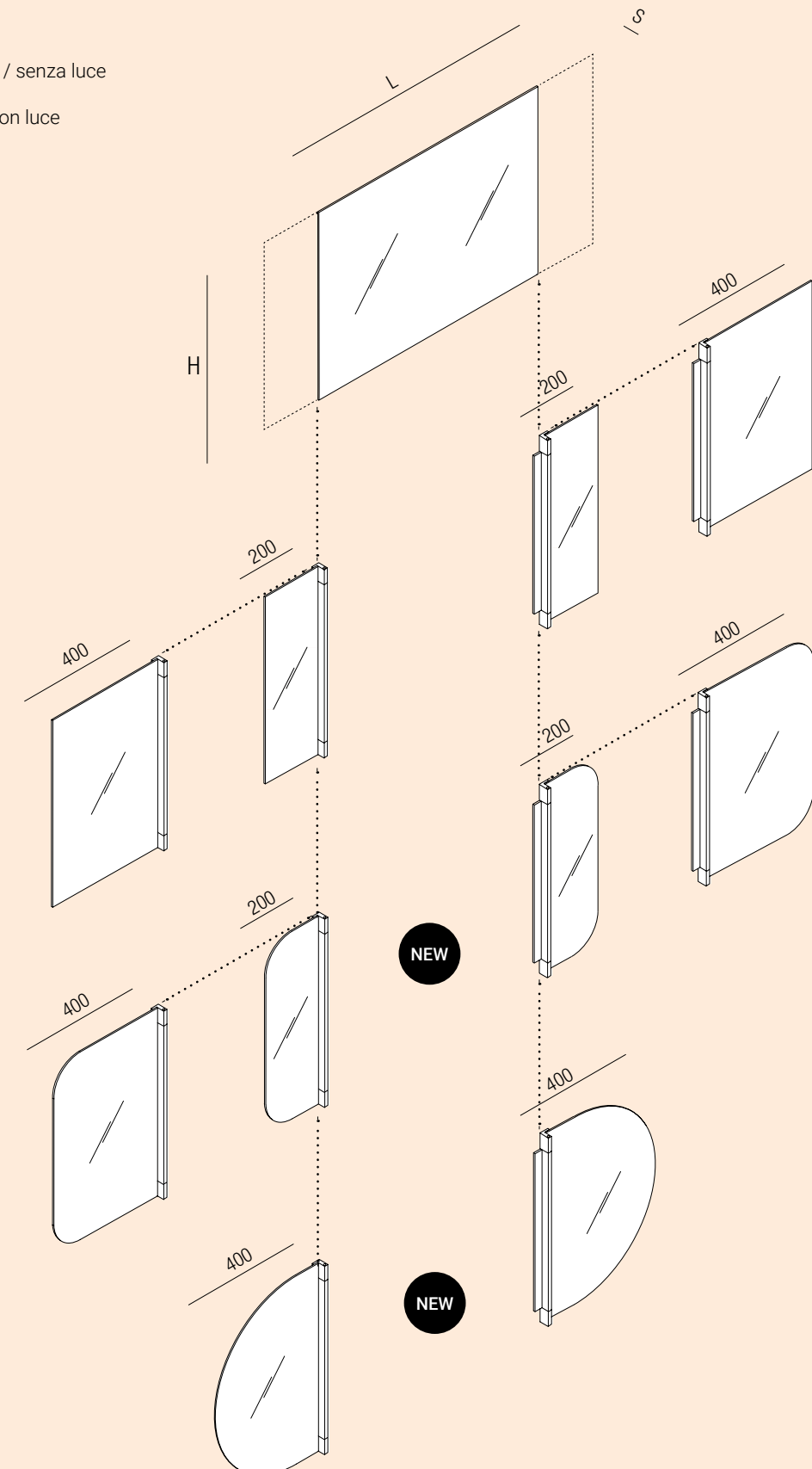

Nudo

Mirror / Specchio

Horizontal or vertical, with pure, clean lines, Nudo mirrors come in a variety of sizes. They can be made to measure. The mirrors can be fitted with Nudo LED lighting, the contrasting thickness between the two elements creates a play of lights on the mirrored surface enhanced by a white reflective band.

Orizzontali o verticali, assolutamente puri nella loro essenzialità, gli specchi Nudo vengono proposti in diverse dimensioni. E' possibile anche richiedere una realizzazione su misura. Nudo può essere affiancato a Nudo LED, la diversità di spessore dei due elementi, permette di creare giochi di luce sulla superficie specchiante che sarà dotata di fascia riflettente bianca.

The item is developed in several variants, the codes relating to the multiple dimensions are available on the price list /

L'articolo si sviluppa in più varianti, i codici relativi alle molteplici dimensioni sono disponibili sul listino

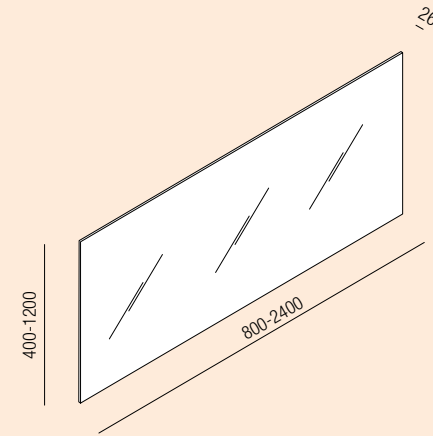

design RD Agape, 2006



Nudo LED

Mirror / Specchio

Nudo LED maintains the essential shape of the version without light and the possibility of horizontal or vertical fixing to meet every need, thanks also to the various dimensional types. Nudo and Nudo LED can be placed side by side giving life to new compositional possibilities.

Nudo LED mantiene la forma essenziale della versione senza luce e la possibilità di fissaggio in orizzontale o verticale per rispondere ad ogni esigenza, grazie anche alle varie tipologie dimensionali. Nudo e Nudo LED possono essere affiancati dando vita a possibilità compositive inedite.

The item is developed in several variants, the codes relating to the multiple dimensions are available on the price list /

L'articolo si sviluppa in più varianti, i codici relativi alle molteplici dimensioni sono disponibili sul listino

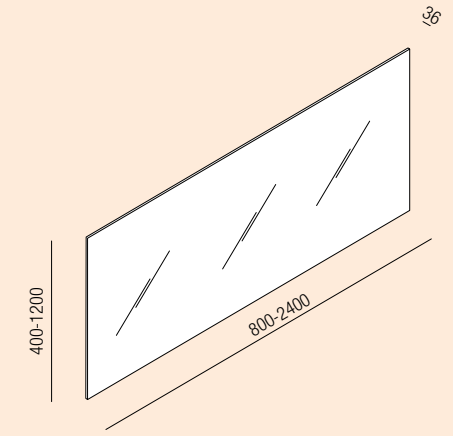

design RD Agape, 2012

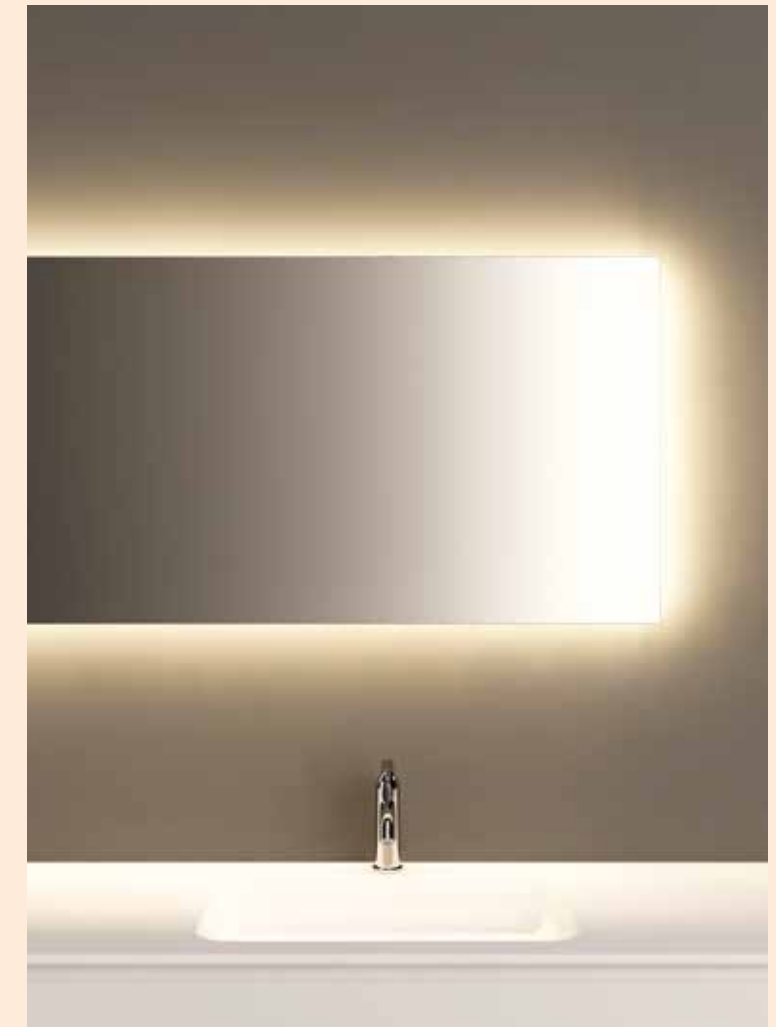

Revolving Moon

Mirror / Specchio

Revolving Moon is a circular wall mounted mirror with magnifier. The possibility of adjusting the magnifying mirror, mounted on a metal bar, into different positions (either horizontally or vertically) ticks all the boxes for a practical, yet fun and elegant element, creating a formal, yet dramatic effect of a moon orbiting the planet. The mirror, made of black coated MDF, can be installed with the magnifier on either the right or left.

Revolving Moon è uno specchio tondo da parete con ingranditore. Le diverse possibilità di regolazione (in orizzontale e verticale) dello specchio ingranditore montato su barra metallica, permettono di rispondere a tutte le esigenze funzionali in un divertente ed elegante gioco di rimandi formali e cinematografici all'orbita di un satellite attorno al suo pianeta. Lo specchio, realizzato in MDF verniciato nero, può essere installato con l'ingranditore sia a destra che a sinistra.

ASPE039E

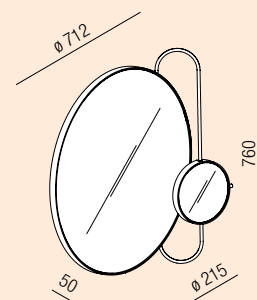

design Studiopepe, 2018



Seppia

Mirror / Specchio

The rounded corners of this design recall the mathematical concept of the superellipse. Halfway between a rectangle and an oval, this mirror by Benedini Associati echoes a shape commonly seen in furniture and car design of the 1960s and 70s, bringing its elegance back to center stage. Seppia's free and ineffable lines avoid harsh geometrical angles, in harmony with the welcoming atmosphere offered by Agape's bathroom design. The mirror can be back-lit with LED lighting and can be positioned horizontally or vertically according to the needs of the space.

Con i suoi angoli smussati, Seppia rimanda al concetto matematico di superellisse. A metà strada fra rettangolo e ovale, lo specchio progettato da Benedini Associati cita una forma che possiamo ritrovare negli arredi e nel car design degli anni '60 e '70 del '900 e ne riprende la purezza. La geometria libera e non definibile in modo univoco di Seppia evita l'eccessivo rigore, in sintonia con l'atmosfera accogliente dell'ambiente bagno di Agape. Lo specchio può essere retroilluminato con luce a LED ed è posizionabile in orizzontale o in verticale, a seconda delle tipologie di spazio.

ASPE0370
ASPE037V

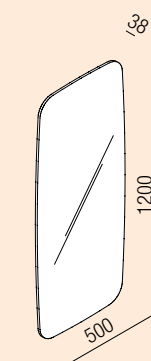

ASPE037L

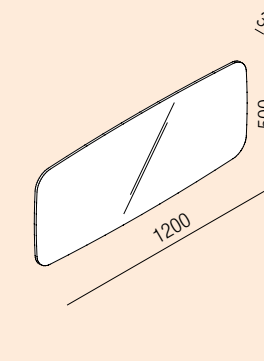

design Benedini Associati, 2021



Solid

Mirror / Specchio

The Solid mirror recalls a drop of molten metal, but it is made of blown glass: a technique with millennial tradition, combined with the industrial treatment of “metal coating” that makes the frame surface become a mirror when the light is switched off and lets the light pass when it is switched on.

Lo specchio Solid ricorda una goccia di metallo fuso, ma è realizzato in vetro soffiato: una tecnica di millenaria tradizione con in più un trattamento industriale di “metal coating” che rende la superficie della cornice riflettente quando la sorgente luminosa interna è spenta e lasciando attraversare la luce quando è accesa.

ASPE05991L

Blown glass
frame / Cornice
in vetro soffiato

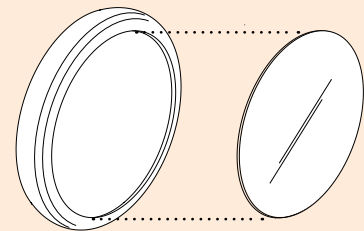

Mirror / Specchio

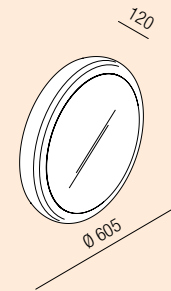

design Diego Vencato, Marco Merendi, 2014

**Solid**

Mirror / Specchio

Working around the idea of a mirror we were fascinated with the concept of giving volume to an object that is usually flat. We imagined it like a drop of liquid metal on the wall, but the idea of a single glass object was both beautiful and difficult to achieve. The three-dimensional volume had to have a function, and so it became the ideal location for the integrated light of the mirror. Then we concentrated on the finishing, one of the key elements of the project. The metal coating process (a technology usually used for industrial parts) made the matter semi-transparent so as to be permeable to light. The result is an almost neo-primitive object, strong and delicate at the same time. The entire volume is in metallized glass. The front has a perfect reflection for the use and the thickness of the side, once you turn the mirror on, it allows light to pass for the ambient lighting.

Lavorando intorno all'idea di uno specchio abbiamo trovato affascinante la possibilità di dare volume ad un oggetto che solitamente è piatto. Lo abbiamo immaginato come una goccia di metallo liquido sulla parete, ma l'idea di fare un oggetto monomaterico in vetro era tanto bella quanto difficile da realizzare. Il volume tridimensionale doveva avere una funzione e così è diventato la sede ideale per l'illuminazione integrata dello specchio.

Ci siamo quindi concentrati sulla finitura, uno degli elementi fondamentali del progetto: il processo di metal coating (tecnologia solitamente usata per pezzi industriali) ha reso semitrasparente la materia in modo da essere permeabile alla luce. Ne è uscito un oggetto quasi neoprimitivo, forte e delicato al contempo. L'intero volume è in vetro metallizzato: la parte frontale ha una riflessione perfetta per l'uso e lo spessore laterale, una volta acceso lo specchio, lascia passare la luce per l'illuminazione d'ambiente.



Spai

Mirror / Specchio

This small magnifying mirror with chromed plastic frame has a self-adhesive backing that enables it to be positioned anywhere: for example on top of another mirror, or on any other smooth surface. Magnifying power: 2.

Questo piccolo specchio ingranditore, con cornice in materiale plastico cromato, può essere applicato dovunque grazie alla superficie posteriore adesiva: ad esempio su un altro specchio, oppure su un'altra superficie liscia. Fattore di ingrandimento: 2.

ASPE035S

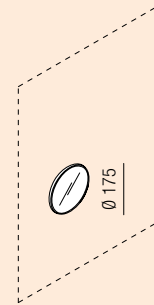

design Benedini Associati, 2006



Spin

Mirror / Specchio

Spin can be adjusted horizontally and in height. It is fitted with two round mirrors, one of which is a magnifying mirror. The support structure is in plywood with a natural, brown or dark oak or reconstituted wood, teak finish, or in white and grey.

Orientabile orizzontalmente e regolabile in altezza, Spin è dotato di due specchi rotondi, di cui uno ingranditore. La struttura è in legno multistrato con finitura rovere naturale, bruno, scuro, legno precomposto con finitura teak o nei colori bianco e grigio.

ASPE013_

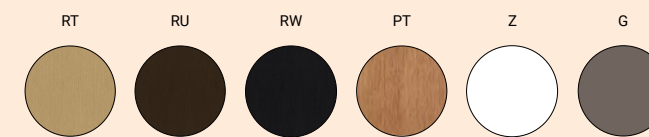
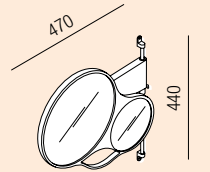

design Benedini Associati, 1998



Vitruvio

Mirror / Specchio

A circle inscribed in a square. García Cumini's new collection of mirrors designed for Agape reinterprets classical style through a contemporary understanding of proportion and beauty. Like in theatre mirrors, an LED light surrounds the reflective surface, creating a clean line that illuminates without casting shadows. Vitruvio is available in three sizes - 60, 80 and 120 cm. They can be freely mix-and-matched, and are perfect for any type of space. A modular concept, suited to many varied and "reflective" compositions.

Un cerchio inscritto in un quadrato. La nuova collezione di specchi progettata da García Cumini per Agape guarda alla classicità in una visione contemporanea della proporzione e della bellezza. Come negli specchi teatrali una luce LED circonda la superficie riflettente e diventa una linea purissima capace di illuminare senza creare ombre. Vitruvio è disponibile in tre dimensioni, da 60, 80 e 120 cm, liberamente combinabili fra loro e adatte a tutti gli spazi. Una concezione modulare aperta a molteplici composizioni di sequenze specchianti.

ASPEV66LE

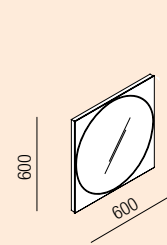

ASPEV1212LE

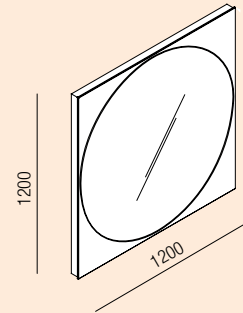

ASPEV88LE

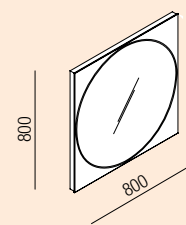

design García Cumini, 2021



Storage units / Contenitori

Even a small space can be put to valuable use with Agape storage units. To conveniently store everything needed for well-being and body care, but also to introduce the warmth of wood or the excitement of colour into the bathroom.

Anche un piccolo spazio può diventare prezioso, con i contenitori Agape. Per riporre e tenere sempre a portata di mano tutto quanto serve al benessere ed alla cura della propria persona, ma anche per introdurre nella stanza da bagno il calore del legno o le emozioni del colore.



floor standing /
da appoggio

wall mounted /
a parete

Flat XL		p. 370
Lato		p. 376
Lift		p. 384
O.J.C.	p. 369	
Plus		p. 388

O.J.C. Storage unit / Contenitore

Warmth and dynamism are the characteristic features of O.J.C., the storage trolley unit in natural, brown or dark oak or reconstituted wood, teak finish, or in white or grey lacquer, divided into three sections, accessible from the top with swivel opening and a chromed brass handle.

Calore e dinamismo caratterizzano O.J.C., il contenitore su ruote in rovere naturale, bruno, scuro, legno precomposto con finitura teak o laccato in bianco o grigio, diviso in tre settori fruibili dall'alto con apertura a rotazione e una maniglia in ottone cromato.

ACOM0500N_

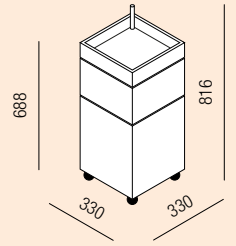

design Benedini Associati, 1991 / 2014



Flat XL

Storage units / Contenitori

Containers from the Flat XL range, to be freely positioned, with open compartments or drawers, 20 or 40 cm high, with two depths and 5 widths: 40, 60, 80, 100 and 120 cm. Casing in natural, brown, grey ash or dark oak, reconstituted wood with teak finish, white or dark grey lacquer.

Front panels are in the same finishes, plus additional colours: light grey painted, and in white or grey Exacril. Handles in polished, satin, painted white or black stainless steel, in oak or reconstituted wood with teak finish, or with push-pull opening.

Contenitori del programma Flat XL che possono essere collocati liberamente, a giorno o con cassetti, alti cm 20 o 40 con due profondità e 5 larghezze cm 40, 60, 80, 100 e 120. Cassa in rovere naturale, bruno, scuro, cenere, legno precomposto con finitura teak o laccata bianca o grigio scuro. Frontali nelle stesse finiture più altri colori: laccato grigio chiaro e Exacril bianco o grigio. Maniglie in acciaio inox lucido, satinato o laccate in bianco o nero, in rovere o legno precomposto con finitura teak o con apertura push-pull.

AFXMO_

design Benedini Associati, 2002



Flat XL

Storage units / Contenitori

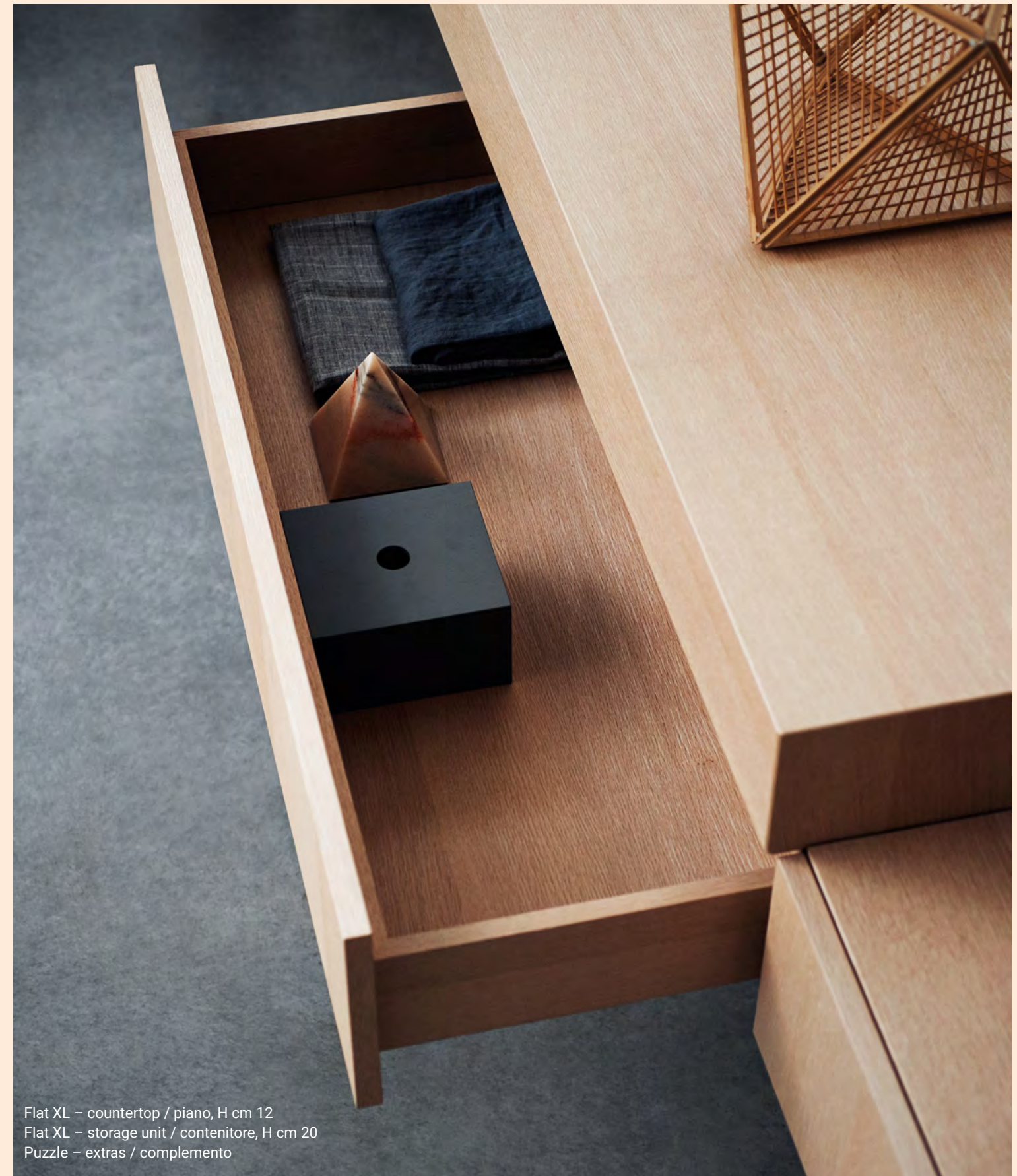

Flat XL – countertop / piano, H cm 12
 Flat XL – storage unit / contenitore, H cm 20
 Puzzle – extras / complemento

Flat XL

Storage units / Contenitori

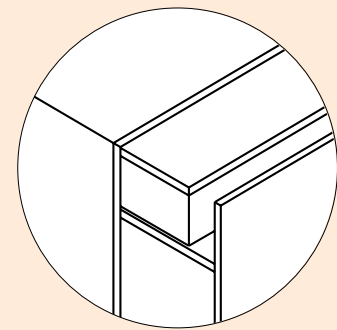

Variation with inside drawer / Variante con cassetto interno

Casing in MDF with wood veneer or matt laquered. Depth of the casing 40,5 or 48 cm / Cassa in MDF con rivestimento in essenza o laccata con finitura opaca. Profondità della cassa cm 40,5 o cm 48

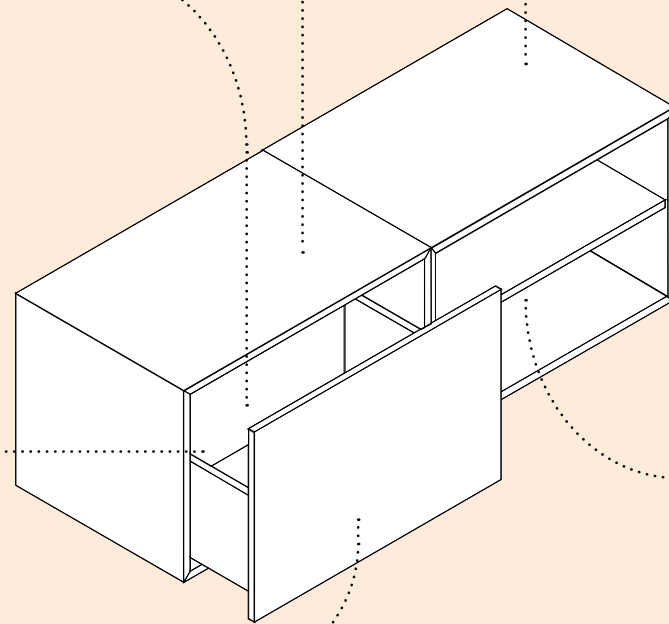
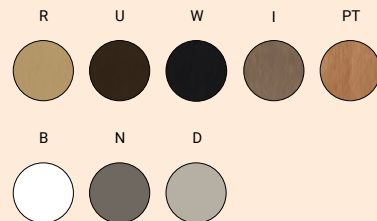

Drawer / Cassetto



Open storage unit / Contenitore a giorno

Front / Frontale

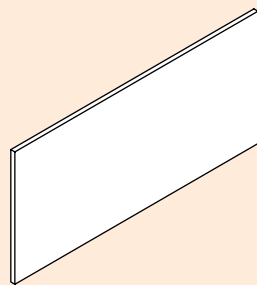

Handles / Maniglie

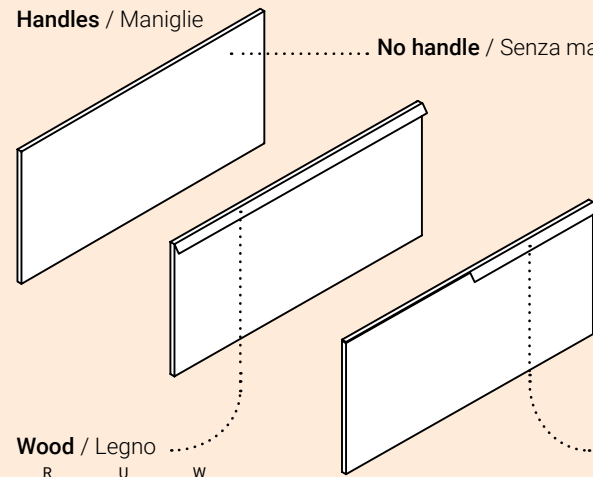

No handle / Senza maniglia

Wood / Legno



Steel / Acciaio

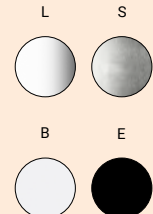

Flat XL

Storage units / Contenitori

L 40 / 60 / 80 / 100

AFXM0135_

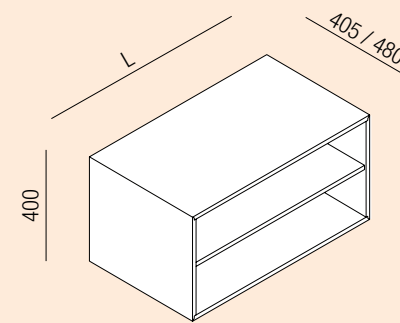

Open storage units / Contenitore a giorno

L 40 / 60 / 80 / 100 / 120

AFXM0151_

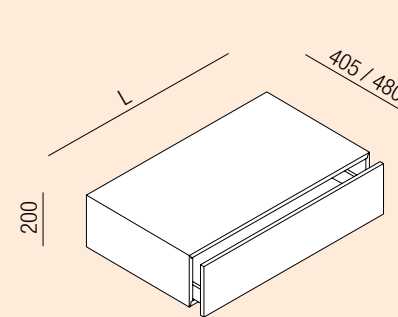

Storage unit with drawer / Contenitore con cassetto

AFXM0170_

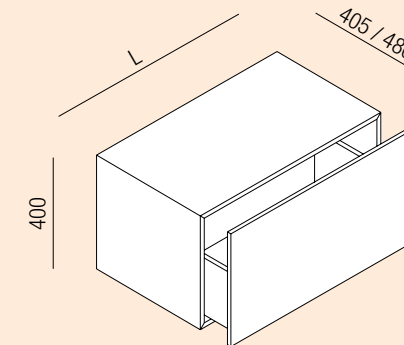

Storage unit with drawer / Contenitore con cassetto

AFXM0198 _

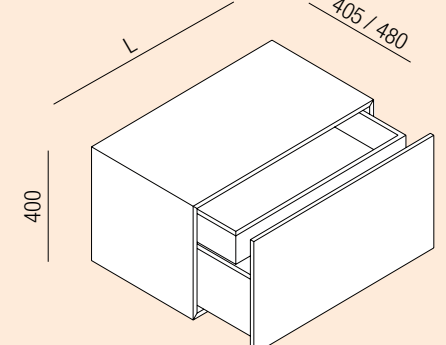

Storage unit with drawer and internal drawer / Contenitore con cassetto e cassetto interno

L 60 / 80 / 100 / 120 (p. 480) – L 80 (p. 405)

AFXM0174_

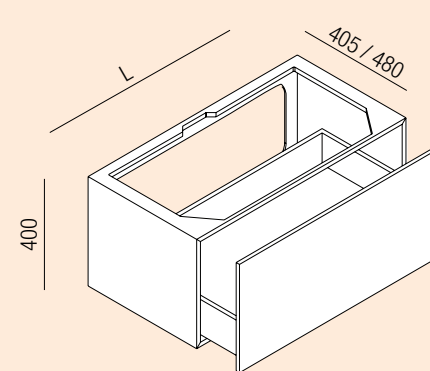

Storage unit under basin with drawer / Contenitore sottolavabo con cassetto

Flat XL

Storage units / Contenitori

Flat XL – countertop / piano, H cm 6
Flat XL – storage unit / contenitore, H cm 20



Flat XL

Storage units / Contenitori



Flat XL – countertop / piano, H cm 6
Flat XL – storage unit / contenitore, H cm 20

Lato

Storage units / Contenitori

Designed by Benedini Associati, Lato is a complete range of cabinets versatile enough to please all tastes and trends, including the most innovative and original. Drawer fronts come in a variety of finishes: wood, marble, leather, or lacquered and coloured. Customized to the centimetre in width when the configuration includes open storage units and available in two heights, 40 and 20 cm, casing drawers can be finished in different woods or lacquered allowing to create a variety of different solutions.

Disegnato da Benedini Associati, Lato è un programma completo di contenitori che si propone di rappresentare diverse tendenze estetiche, anche innovative o inconsuete, giocando con una molteplicità di finiture sui frontali dei cassetti: dai legni, ai marmi, al cuoio, ai colori laccati. Disponibili con larghezze personalizzabili al centimetro quando la configurazione prevede i vani a giorno e in due altezze, cm 40 e 20, le casse dei contenitori possono essere a loro volta rivestite in legno in diverse essenze, oppure laccate, in modo da creare una grande varietà di soluzioni.

design Benedini Associati, 2015



Lato

Storage units / Contenitori



Lato – storage unit / contenitore, H cm 20

Lato

Storage units / Contenitori

Casing in plywood with wood covering of various essences.
Depth of the casing 47,7 cm
/ Cassa in multistrato con rivestimento in legno di varie essenze. Profondità della cassa cm 47,7

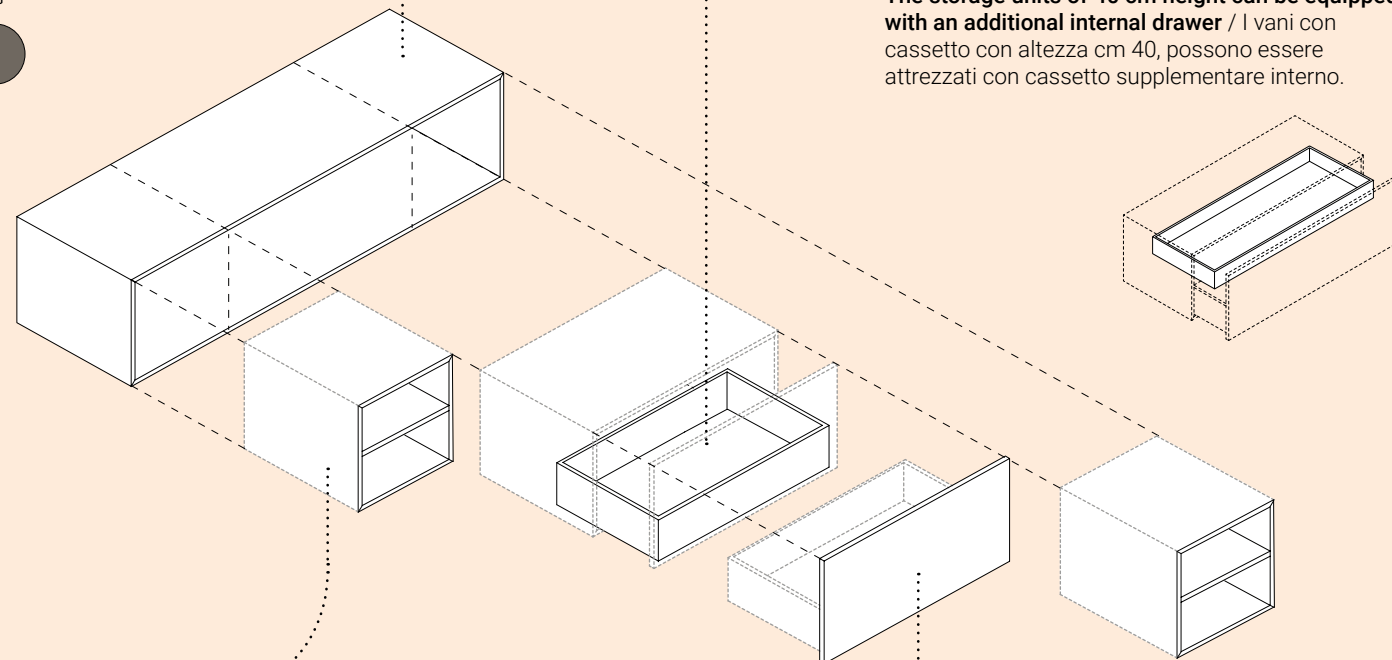
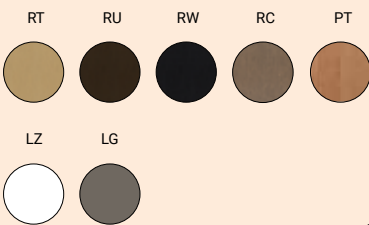

The open compartments have standard lengths of 40 or 60 cm, and are available in the same finish as the casing. Other than the standard measurements, special dimensions are possible / I vani a giorno hanno dimensioni standard cm 40 o 60, sono disponibili nella stessa finitura della cassa. Oltre alle misure standard sono possibili dimensioni speciali

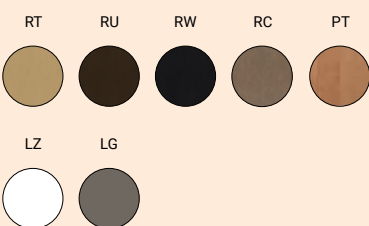

Drawer. The drawers have fixed measures: 40, 60, 80, 100, 120 cm. They are equipped with full extraction runners with push-pull opening and soft closing mechanism / Cassetto. I cassetti hanno misure fisse: cm 40, 60, 80, 100, 120. Sono dotati di guide ad estrazione totale con apertura push-pull e chiusura soft-closing

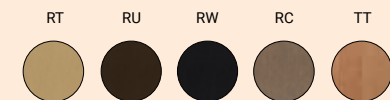

The storage units of 40 cm height can be equipped with an additional internal drawer / I vani con cassetto con altezza cm 40, possono essere attrezzati con cassetto supplementare interno.

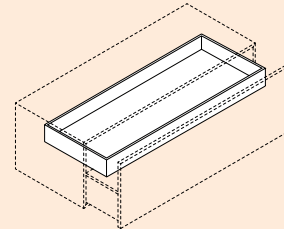

Front. The front of the drawers have fixed measurements: 40, 60, 80, 100 and 120 cm. All the fronts are supported by a MDF panel lacquered dark grey. / Frontale. I frontali dei cassetti hanno misure fisse: cm 40, 60, 80, 100, 120. Tutti i frontali sono supportati da pannello in MDF laccato grigio scuro.



Lato

Storage units / Contenitori

The storage units' casings are available in lengths of 80 to 200 cm, height 20 or 40 cm, depth 47,7 cm. Storage units are also possible with special dimensions when the configuration includes open storage units / Le casse dei contenitori sono disponibili con larghezze da cm 80 a cm 200, altezza cm 20 o 40 e profondità cm 47,7. Sono possibili anche contenitori con dimensioni speciali quando la configurazione prevede i vani a giorno

ALC4_

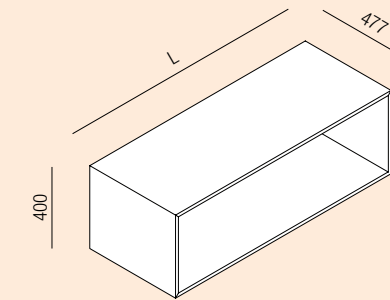

ALC2_

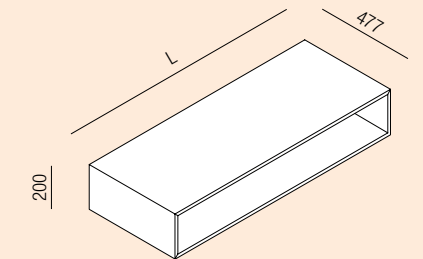

The drawers have fixed measures: 40, 60, 80, 100 and 120 cm. The drawer finish is the same as the casing, when this is in wood: when it is lacquered it must be chosen from the wood finishes available. The drawers are equipped with full extraction runners with push-pull opening and soft-closing mechanism (capacity 40 kg) / I cassetti hanno misure fisse: cm 40, 60, 80, 100, 120. La finitura del cassetto è la stessa della cassa quando questa è in legno; quando è laccata deve essere scelta tra le finiture legno disponibili. I cassetti sono dotati di guide ad estrazione totale con apertura push-pull e chiusura soft-closing (portata 40 kg)

ALD4_

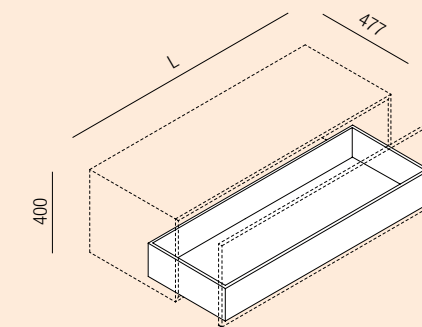

ALD2_

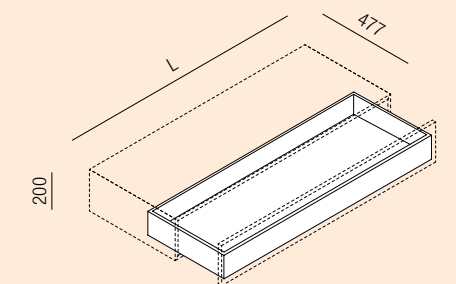

The drawers of the Lato storage units of 40 cm height can be equipped with an additional, internal drawer. The finish of the internal, additional drawer is the same as the main drawer / I cassetti dei contenitori Lato con altezza cm 40, possono essere attrezzati con un cassetto supplementare interno. La finitura del cassetto supplementare interno è la stessa del cassetto principale

ALI_

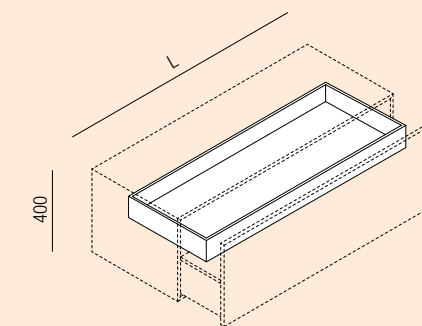

The front of the drawers have fixed measurements: 40, 60, 80, 100 and 120 cm. All the fronts are supported by a MDF panel lacquered dark grey / I frontali dei cassetti hanno misure fisse: cm 40, 60, 80, 100, 120. Tutti i frontali sono supportati da pannello in MDF laccato grigio scuro

ALF4_

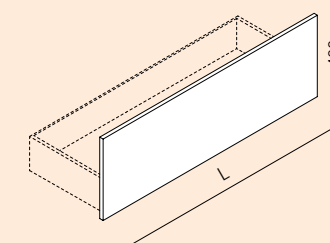

ALF2_

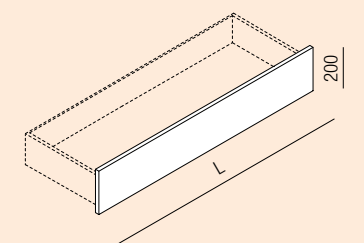

Lato

Storage units / Contenitori

Examples of compositions of 40 cm height, also available for 20 cm height / Esempi di composizioni con altezza cm 40, le stesse sono possibili con altezza cm 20

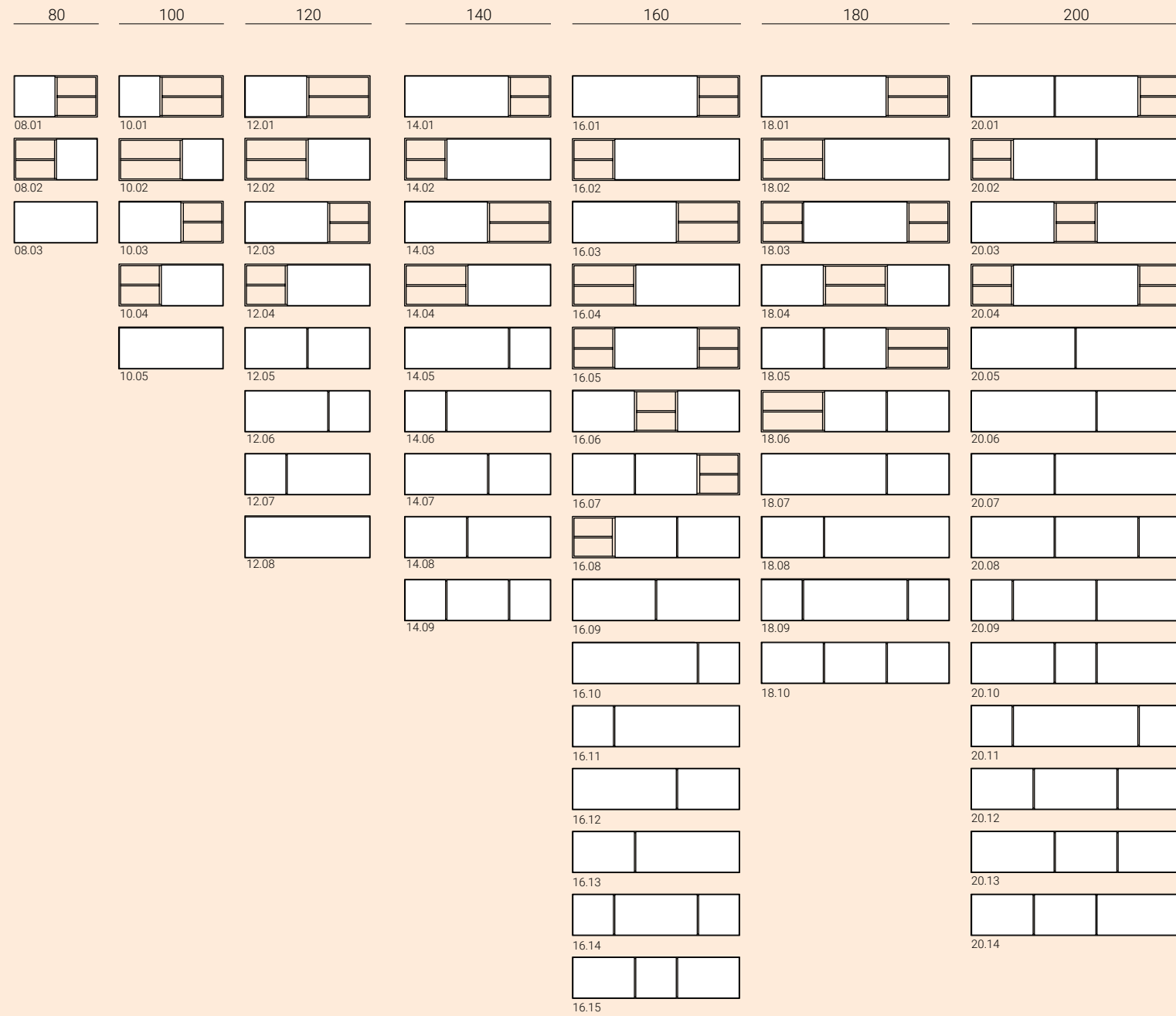

Lato

Storage units / Contenitori

- Bjhon 1 – washbasin / lavabo
- Flat XL – countertop / piano
- Lato – storage unit / contenitore
- Memory – taps / rubinetteria
- Eclissi – mirror / specchio
- Memory – shelf / mensola



Lato

Storage units / Contenitori



E11 – washbasin-countertop / piano lavabo
Lato – H cm 40, storage unit / contenitore

Lato

Storage units / Contenitori



E11 – washbasin-countertop / piano lavabo
Lato – H cm 20, storage unit / contenitore

Lift

Storage units / Contenitori

Lift is a programme of wall mounted and modular storage units for organising and furnishing a room with a range of vertical and horizontal compositions. There is a wide choice of door finishes: wood, marble, brass, leather and mirrored, offering a variety of solutions which are an ideal complement to the Flat XL, Evoluzione and Lato systems. Lift containers can be requested, when ordering, complete with electrified bar on which to attach various types of adapters for connecting electrical appliances.

Lift è un programma di contenitori pensili e modulari che consentono di organizzare e arredare l'ambiente, spaziando in verticale e in orizzontale. Ampia anche la scelta delle finiture delle ante: legno, marmo, cuoio, ottone e specchio, per creare le più diverse soluzioni, in ideale abbinamento con i sistemi Flat XL, Evoluzione e Lato. I contenitori Lift possono essere richiesti, in fase di ordine, completi di barra elettrificata sulla quale agganciare vari tipi di adattatori per il collegamento di apparecchi elettrici.

See versions and dimensions at page 386
/ Vedi le versioni e le dimensioni a pagina 386

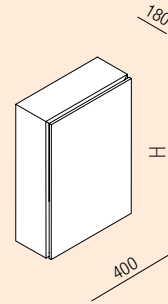

design Benedini Associati, 2018



Lift

Storage units / Contenitori



Lift

Storage units / Contenitori

AMOB051_

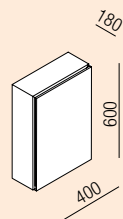

Container with door, height
60 cm / Contenitore con anta,
altezza cm 60

AMOB052_

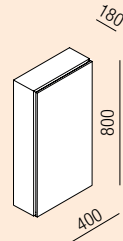

Container with door, height
80 cm / Contenitore con anta,
altezza cm 80

AMOB053_

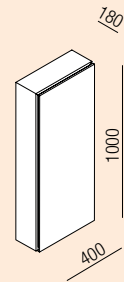

Container with door, height
100 cm / Contenitore con anta,
altezza cm 100

AMOB054_

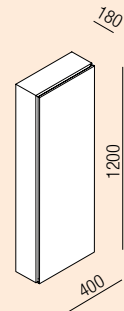

Container with door, height
120 cm / Contenitore con anta,
altezza cm 120

Casing, 18 cm deep and 40 cm
wide, in four heights: 60, 80,
100 and 120 cm / Cassa con
profondità cm 18 e larghezza cm
40, realizzata in quattro altezze:
cm 60, 80, 100 e 120

Finish of casing / Finitura cassa

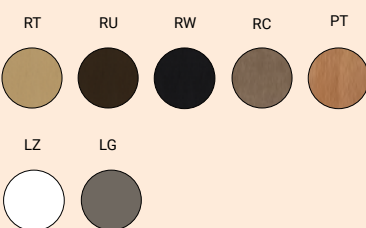

The hinged door, with opening on
the right or on the left is equipped
with amortized hinges with push-
pull or traditional opening / L'anta
a battente, con apertura a destra
o a sinistra è dotata di cerniere
ammortizzate con apertura
push-pull o tradizionale

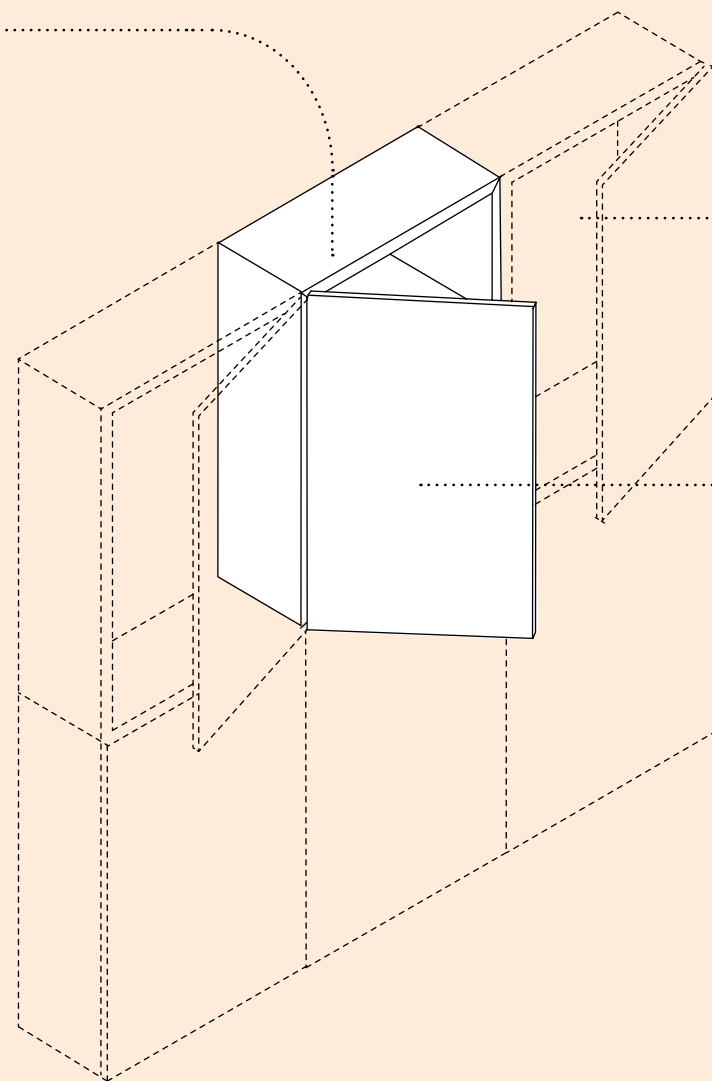

The storage units can be
combined both vertically and
horizontally / I contenitori
possono essere affiancati sia in
verticale che in orizzontale

Finish of front / Finitura anta



Lift

Storage units / Contenitori

.ELE253



Adaptor Italy ITA4 / Adattatore
Italia ITA4

.ELE258



Adaptor Schuko GS4 / Adattatore
Schuko GS4

.ELE255



Adaptor Great Britain BS4 /
Adattatore Gran Bretagna BS4

.ELE256



Adaptor France FR4 / Adattatore
Francia FR4

The Lift mirror units can be
requested complete with
electrified bar with possibility
to install various types of
adaptors to connect electrical
devices (.ELE257E) / Gli
specchi contenitori Lift possono
essere richiesti completi di
barra elettrificata sulla quale
agganciare vari tipi di adattatori
per il collegamento di apparecchi
elettrici (.ELE257E)

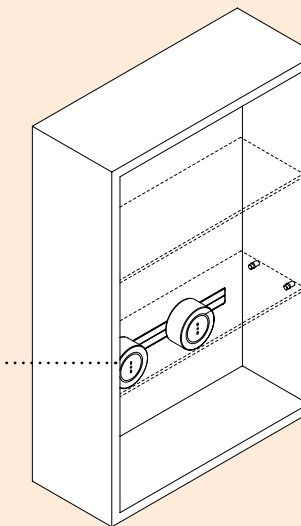

Discover the
Lift collection
mirrors cabinets
at page 348
/ Scopri
gli specchi
contenitori della
collezione Lift a
pagina 348

Plus

Storage units / Contenitori

Containers featuring a sturdy front panel, serving both as a towel holder and as a handle to open the drawer. Casing in MDF, covered with natural, brown, dark oak, grey ash oak or reconstituted wood with teak finish, white, light grey or dark grey matt lacquer. The front panel and towel holder are available in the same finishes as the casing, and can be freely mixed and matched. Height 40 cm, widths: 40, 60, 80, 100 cm.

Contenitori con frontale a forte spessore il quale serve sia da porta salviette, che da maniglia per l'apertura del cassetto. Cassa in MDF con rivestimento in rovere naturale, bruno, scuro, cenere o in legno precomposto con finitura teak oppure laccato opaco in bianco, grigio chiaro o grigio scuro. Il frontale ed il porta salviette sono disponibili nelle stesse finiture delle casse e possono essere combinati a piacere. Altezza cm 40 con larghezza cm 40, 60, 80, 100.

AFXMO_

Selected "ADI DESIGN INDEX" 2013

design Javier López, 2015



Plus

Storage units / Contenitori

Casing / Cassa

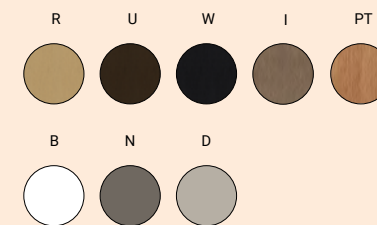
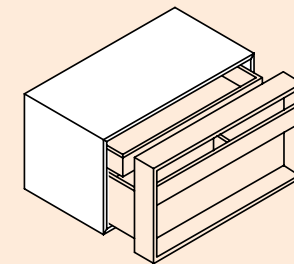

Flat XL container with 50 cm depth / Contenitore Lato o Flat XL con profondità cm 50

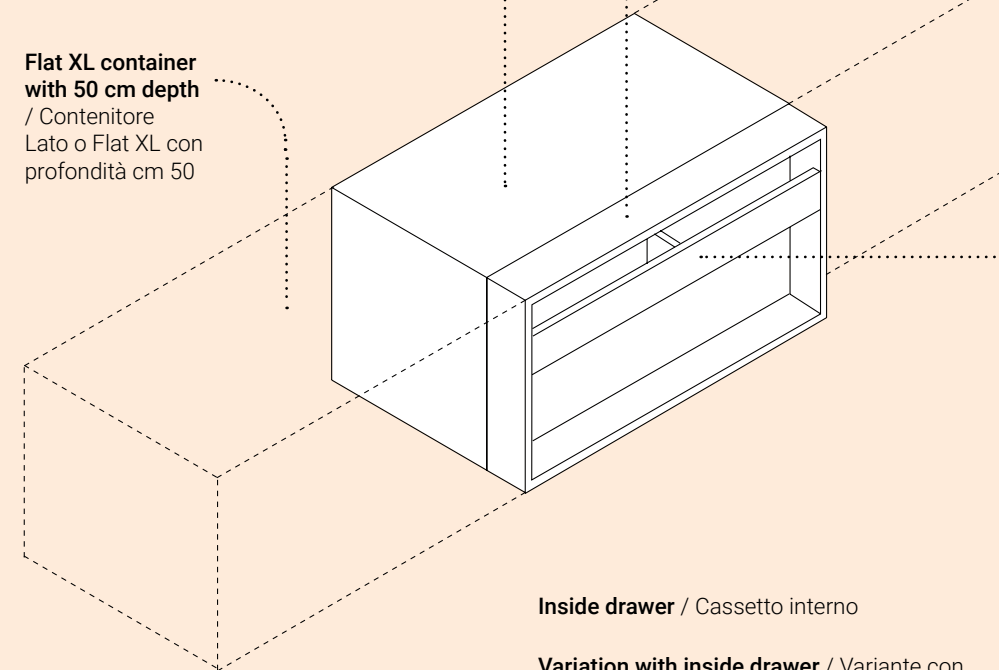

Plus can be combined with the containers of the Lato or Flat XL programs / Plus può essere affiancato ai contenitori dei programmi Lato o Flat XL

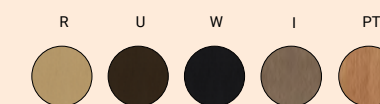
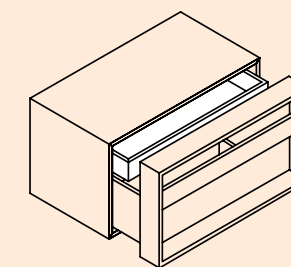

Front / Frontale

Thick front which support the handle for the opening of the drawer / Frontale a forte spessore che sorregge la maniglia per l'apertura del cassetto

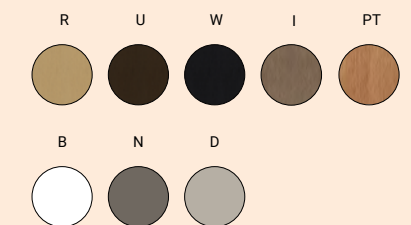
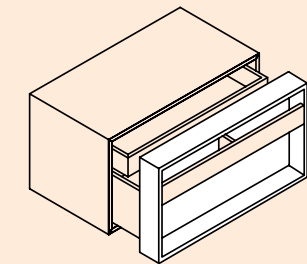

Towel holder / Porta salviette

Horizontal element that serve as towel holder and handle for the opening of the drawer / Elemento orizzontale che serve sia da porta salviette, che da maniglia per l'apertura del cassetto

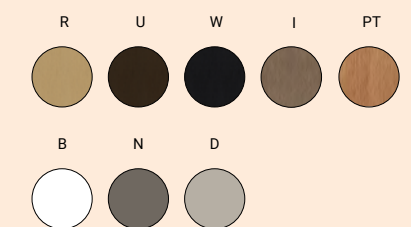
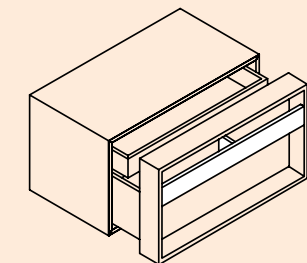

Inside drawer / Cassetto interno

Variation with inside drawer / Variante con cassetto interno

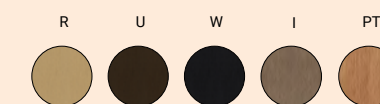

Plus

Storage units / Contenitori

Storage unit with drawer / Contenitore con cassetto

Storage unit with drawer and internal drawer / Contenitore con cassetto e cassetto interno

L 40 / 60 / 80 / 100

AFXM0245_

AFXM0246_

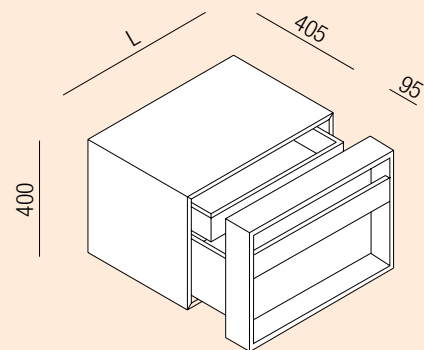
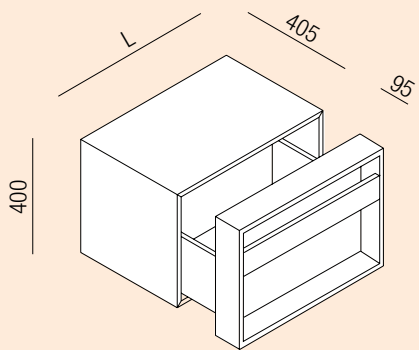
**Plus**

Storage units / Contenitori



815 – washbasin / lavabo
 Flat XL Plus – H cm 40, storage unit / contenitore
 Memory – taps / rubinetteria
 Surf – accessories / accessori

Plus

Storage units / Contenitori

Materials / Materiali

Quality and continuous research form the basis of the Agape's selection of materials. Our range is constantly evolving to meet the increasingly personalized needs of customers and to guarantee sustainability and meet the refined aesthetic requirements that have always distinguished us.

Highest quality materials from specialized vendors, destined to last over time and to give life to products that overcome fashions and trends and that adapt to the most diverse production processes, from the highest quality industrial realisation to the unique and exclusive craftsmanship of small family run businesses dating back centuries.

Woods in different essences and shades, marbles ranging from the traditional Carrara marble to the more refined Emperador dark and Petit Granit, eco-friendly solid surface and new materials such as Cementoskin®; and again steel, leather, rubber and plastic materials. All united by in-depth research and shared with selected suppliers and with expert craftsmen, all inspired by the same philosophy and with the same purpose: quality and celebration of Made in Italy. A choice that requires commitment, continuous work and long-lasting relationships along the entire supply.

Qualità e ricerca continua sono alla base della scelta dei materiali che Agape propone. La nostra gamma è in continua evoluzione per soddisfare le esigenze sempre più personalizzate dei clienti e per garantire allo stesso tempo i requisiti di sostenibilità e raffinata estetica che da sempre ci contraddistinguono.

Materiali di altissima qualità provenienti da fornitori specializzati, destinati a durare nel tempo e a dare vita a prodotti che superano mode e tendenze e che si adattano ai processi produttivi più diversi, dalla lavorazione industriale di altissima qualità fino all'artigianato unico ed esclusivo di piccole imprese a conduzione familiare risalenti a secoli fa.

Legni in diverse essenze e tonalità, marmi che spaziano dal tradizionale Marmo di Carrara fino ai più raffinati Emperador dark e Petit Granit, solid surface ecosostenibili e materiali inediti come il Cementoskin®; e ancora acciaio, pelle, gomma e materiali plastici. Tutti accomunati da ricerche approfondite e condivise con produttori selezionati o con artigiani esperti, tutti in grado di accompagnare Agape in un percorso comune, ispirati dalla medesima filosofia e con lo stesso fine: qualità e celebrazione del Made in Italy. Una scelta che impone impegno e lavoro continuo ma in grado di creare rapporti di lunga durata lungo tutta la filiera e di realizzare prodotti destinati a distinguersi, talvolta unici.

800 002 – washbasin / lavabo
 Flat XL – countertop / piano
 Flat XL – storage unit / contenitore
 Flat XL Plus – storage unit / contenitore
 Flat V – storage unit / contenitore
 Square – taps / rubinetteria
 Nudo LED – mirror / specchio
 Surf – accessories / accessori

Wood / Legno

The technological heritage shipbuilding is fundamental for designing wooden bathroom furniture. Gondolas, are made from a combination of eight different types of wood. Aging brings out the wood's natural aesthetic characteristics, and increases its performances. Aesthetically speaking, the most fascinating feature of wood is its changing appearance connected with the passing of time visible through the slowly shifting alterations in its colour and grain. Wood is a natural product and it is possible to notice differences between the samples and the items. These differences should not be considered imperfections, but instead are signs of quality. The use of reconstituted wood as an alternative to solid teak wood helps to preserve our planet's natural resources.

Il patrimonio tecnologico della cantieristica navale è un dato fondamentale nella progettazione di elementi in legno per il bagno. Le gondole, sono il risultato dell'unione di otto diverse essenze di legno. L'invecchiamento esalta le naturali doti estetiche del legno aumentando le sue prestazioni. Esteticamente ciò che più affascina del legno è l'aspetto cangiante legato al passare del tempo misurato attraverso il lento mutare delle venature e del colore. Il legno è un prodotto naturale per cui le diversità riscontrate dai campioni o tra i vari articoli non sono da ritenersi imperfezioni ma, al contrario, indice di qualità. L'utilizzo di legno precomposto in alternativa al legno massello di teak, aiuta a preservare le risorse naturali del nostro pianeta.

Finishings / Finiture



Natural oak /
Rovere naturale

Brown oak /
Rovere bruno

Dark oak /
Rovere scuro

Grey ash oak /
Rovere cenere

Reconstituted
wood, teak finish /
Precomposto finitura
teak

Iroko / Iroko

Lacquered wood / Legno laccato

Lacquered wood is a panel of wood, or more often of wood fibers, on which a paint is applied over the entire surface that allows a practically infinite variety of color shades that can be declined in the mat variant.

Il legno laccato è un pannello di legno, o più spesso di fibre di legno, su cui viene applicata una verniciatura su tutta la superficie che permette una varietà di sfumature di colore praticamente infinita declinabili nella variante satinata opaca.

Finishings / Finiture

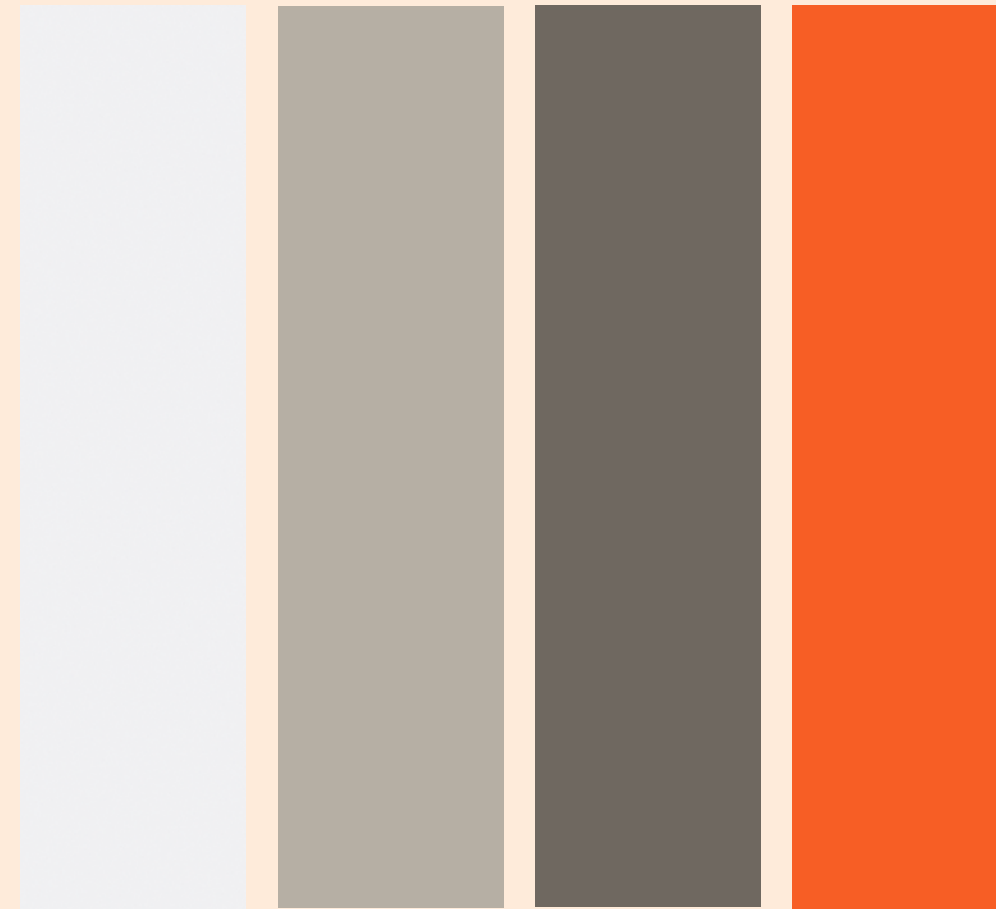

White / Bianco

Light grey / Grigio
chiaro

Dark grey / Grigio
scuro

Orange / Arancione

Lacquered wood open-pore / Legno laccato a poro aperto

The open pore lacquered wood is a wood subjected to a particular type of varnish that allows to preserve and highlight the natural grain of the wood and the characteristics of the surface. Pores, knots, and veins of the wood panel shine through for a result with a more natural effect that gives visibility to the uniqueness of the wood, whose streaks are always different.

Il legno laccato a poro aperto è un legno sottoposto ad un particolare tipo di verniciatura che permette di conservare e mettere in risalto le venature naturali del legno e le caratteristiche della superficie. Pori, nodi, e venature del pannello di legno traspaiono per un risultato dall'effetto più naturale che dà visibilità all'unicità del legno, le cui striature si presentano sempre diverse.

Finishings / Finiture

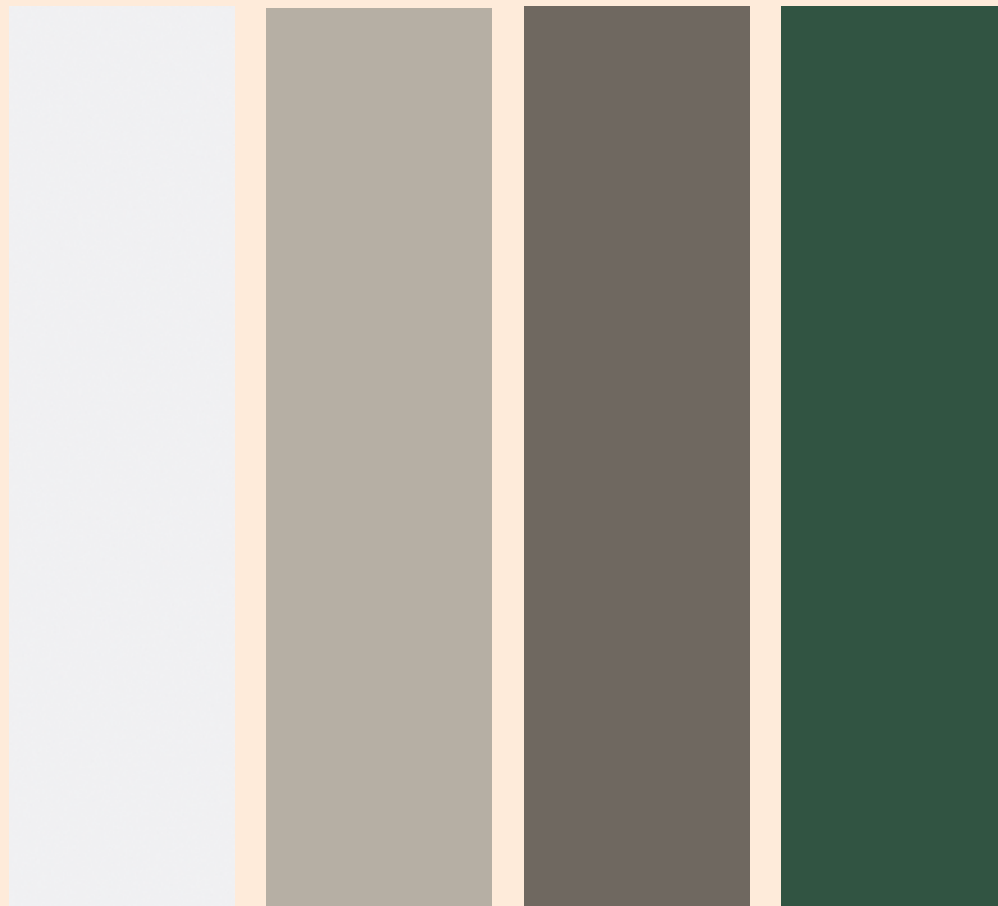

White / Bianco

Light grey / Grigio chiaro

Dark grey / Grigio scuro

Pine Green / Verde Pino

Cristalplant® biobased

Cristalplant® biobased is an environmentally safe material derived from resinous raw materials of plant origin mixed with natural aggregates of extreme purity. The "soft touch" surface looks like natural stone, which makes it particularly suitable for use in the bathroom. The material has uniform structure throughout and can easily be touched up to restore the original finish.

Cristalplant® biobased è un materiale ecosostenibile derivante da materie prime resinose di origine vegetale miscelate a materiali inerti naturali di estrema purezza. La superficie, con effetto "soft touch" ha un aspetto simile alla pietra naturale che lo rende particolarmente indicato per l'utilizzo nell'ambiente bagno. Il materiale è omogeneo in tutto il suo spessore e può facilmente essere ripristinato.

Finishings / Finiture

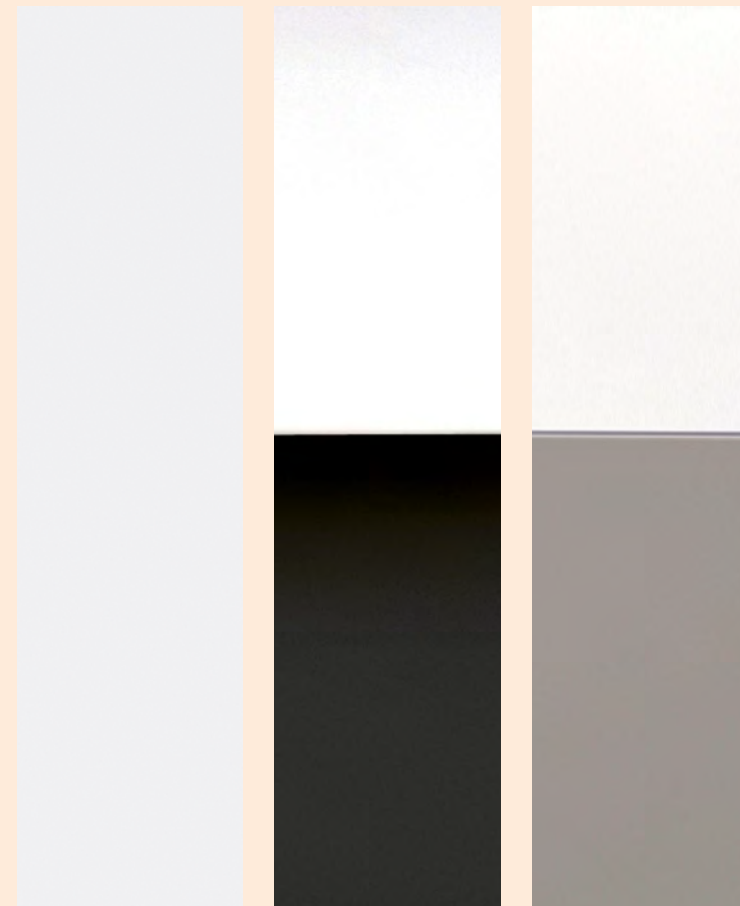

White / Bianco

White/dark grey / Bianco/grigio scuro

White/light grey / Bianco/grigio chiaro

Solid surface

Compact, non-porous material made from a homogeneous composition of 1/3 acrylic resin and 2/3 aluminium hydroxide, a natural mineral that people use every day because it is an important ingredient of toothpaste. The material is completely non-toxic and recyclable. The surface is homogeneous, silky to the touch, durable and easy to clean. Abrasions can be easily removed by sanding and polishing.

Materiale compatto e non poroso, composto in modo omogeneo da 1/3 di resina acrilica e da 2/3 di idrossido di alluminio, un minerale naturale con il quale molte persone si trovano quotidianamente a contatto, poiché costituisce, ad esempio un componente importante dei dentifrici. Completamente atossico e riciclabile. La superficie si presenta omogenea, setosa al tatto, durevole e facile da pulire. Eventuali abrasioni possono essere facilmente rimosse con semplice levigatura.

Finishings / Finiture

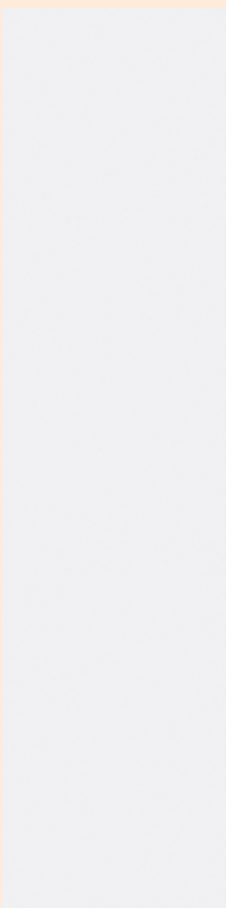

White / Bianco

Ceramilux®

Composite material made with natural mineral content (calcium carbonates and aluminium hydrates) mixed with polyester resins; coated with polyester-based iso-neopentyl gelcoat. Ceramilux® is a non absorbent material, resistant to changes in temperature, scratches and abrasion.

Materiale composito realizzato con cariche minerali naturali (carbonati di calcio e idrati di alluminio) miscelate a resina poliestere; rivestimento con gelcoat a base poliestere isoneopentilica. Ceramilux® è un materiale non assorbente, resistente agli sbalzi di temperatura, ai graffi e all'abrasione.

Finishings / Finiture

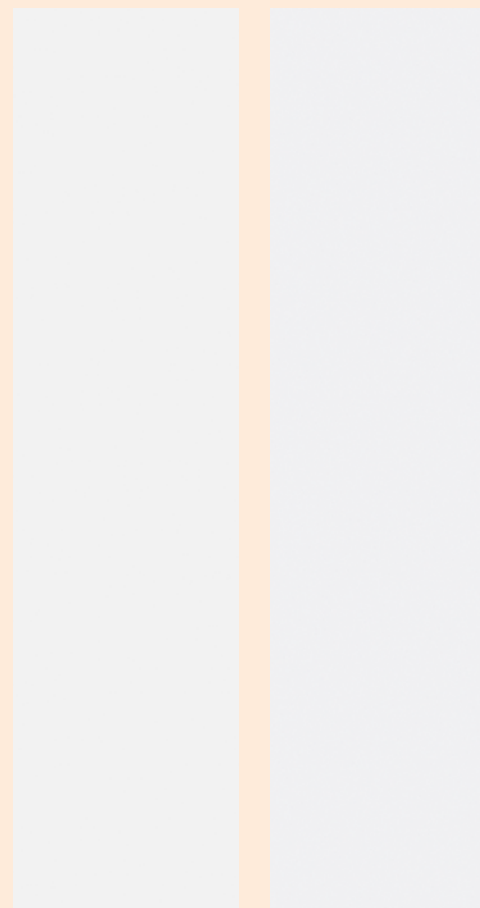

Polished white /
Bianco lucido

Matt white / Bianco
opaco

Cementoskin®

Cementoskin® is a new material, a mixture of cement and resin enriched by carefully chosen aggregates.

An "evolved kind of cement", an agglomerate with high technical and structural performance, even when used with very low thickness. It is cast into shape thus the freedom in selecting the geometrics to realize is high, allowing furthermore a high level of detail and wear resistance.

Resistant to any kind of dirt and suitable for outdoor and indoor situations.

Cementoskin® è un materiale nuovo, generato con un impasto di cemento e resina arricchito di inerti accuratamente selezionati.

È un "cemento evoluto", un agglomerato con elevate prestazioni tecniche e strutturali, anche quando usato con spessori molto ridotti.

Viene lavorato per colatura in stampo e questo consente un'ampia libertà nelle geometrie che si possono ottenere, permettendo inoltre un livello molto alto di dettaglio e una elevata resistenza all'usura.

Il materiale è resistente a qualsiasi tipo di sporco ed è adatto sia ad applicazioni indoor che outdoor.

Finishings / Finiture



Dark grey / grigio scuro



Light grey / Grigio chiaro



Green / Verde

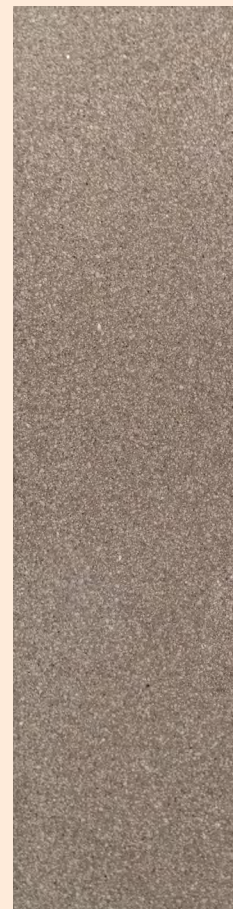

Coffee / Caffè



Brick red / Rosso mattone

Ceramic / Ceramica

Modelled paste made of clay-based substances with a compact structure, it is hardened with firing processes to ensure surface vitrification with high mechanical and electrical resistance.

Impasto di sostanze argillose a struttura compatta modellato e quindi consolidato mediante processi di cottura che ne garantiscono i processi di vetrificazione della superficie, di notevole resistenza meccanica ed elettrica.

Finishings / Finiture

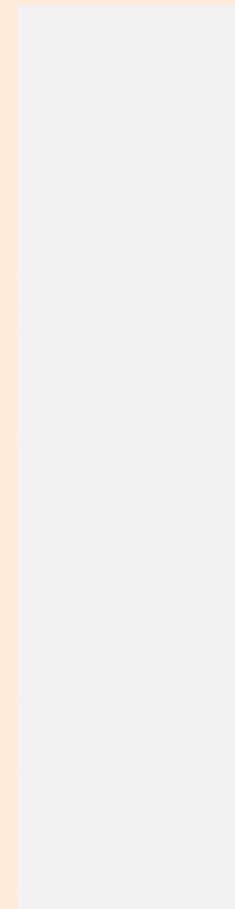

Polished white / Bianco lucido

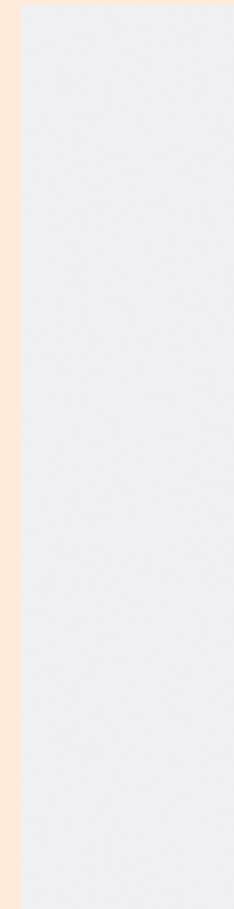

Matt white / Bianco opaco



Polished white - dark grey / Bianco lucido - grigio scuro

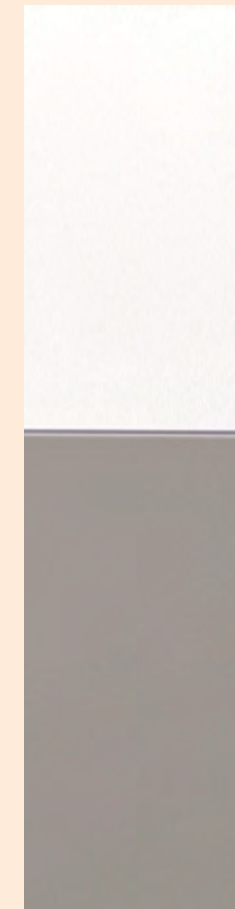

Matt white - light grey / Bianco opaco - grigio chiaro

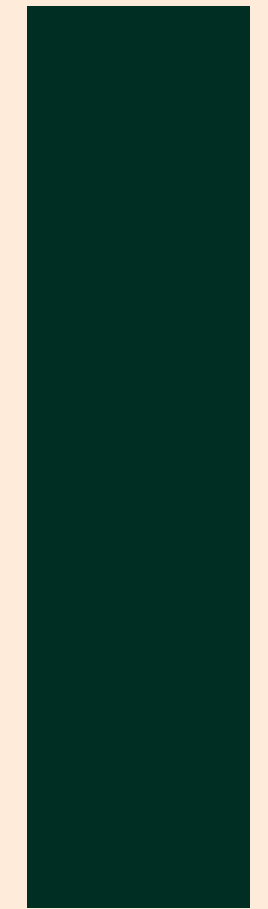

Matt green / Verde opaco



GR - / Grigio scuro opaco

Marble / Marmo

Limestone in compact crystalline state. The term generally refers to all limestone that can be polished. Owing to its strength in compression and ability to withstand high temperatures (up to 650°C), marble is ideal for uses where the material's aesthetic and technical qualities are of paramount importance.

Washbasins are made from either bonded laminated sheets or from carved solid blocks. Marble is a natural product, therefore differences can be noted between samples and various items. These differences should not be considered defects, but instead signs of quality.

Roccia calcarea cristallizzata e compatta.

In generale comprende qualsiasi pietra calcarea che possa essere lucidata. Il marmo si presta, grazie alla resistenza alla compressione e alle alte temperature (fino a 650 gradi), per realizzazioni in cui le qualità tecniche ed estetiche richieste al materiale sono requisiti fondamentali.

I lavabi sono realizzati con lastre unite tramite incollaggio o scavati direttamente su un blocco.

Il marmo è un prodotto naturale per cui le diversità riscontrate dai campioni o tra i vari articoli non sono da ritenersi imperfezioni ma, al contrario, indice di qualità.

Finishings / Finiture

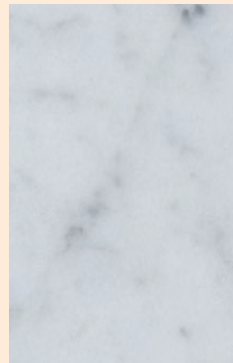

White Carrara marble / Marmo bianco di Carrara

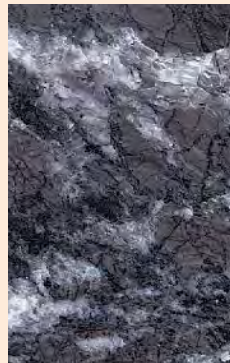

Grey carnica marble / Marmo grigio carnico

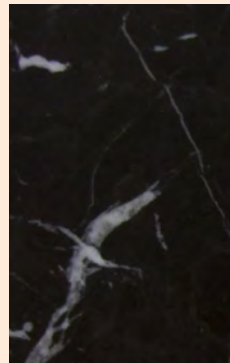

Black Marquina marble / Marmo nero Marquina

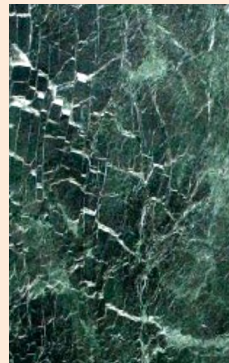

Green Alpi marble / Marmo verde Alpi

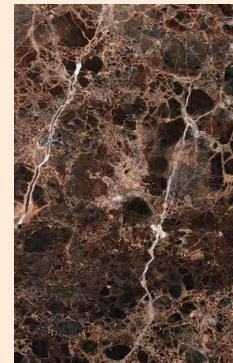

Dark Emperador marble / Marmo Emperador dark

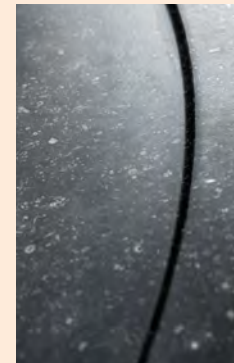

Petit Granit marble / Marmo Petit Granit

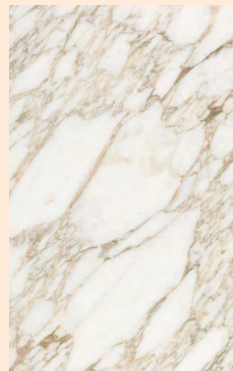

Calacatta Vagli marble* / Marmo Calacatta Vagli*

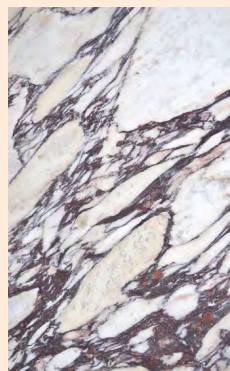

Purple Calacatta marble* / Marmo Calacatta Viola*

***Marble products can be delivered in Calacatta Vagli, Purple Calacatta or in stone on demand** / I prodotti in marmo possono essere forniti in Calacatta Vagli, Calacatta Viola o pietre o marmi a richiesta del cliente

Stainless steel / Acciaio inox

The term "stainless steel" generally indicates types of high alloy steel containing chromium (generally in quantities ranging from 11% to 30%). Other alloying elements that increase resistance to corrosion are nickel, molybdenum, copper, titanium and niobium. In any case, the overall content of alloying elements in steel must not exceed 50%. The properties of resistance, hardness and elasticity of steel are much higher than those of simple iron. Agape stainless steel products are surface treated to obtain polished or satin finishes.

Il termine acciaio inossidabile (o inox) indica genericamente gli acciai ad alta lega contenenti cromo, generalmente in quantità fra l'11% ed il 30%; altri leganti che aumentano la resistenza alla corrosione sono nichel, molibdeno, rame, titanio e niobio: in ogni caso, perchè si possa parlare propriamente di acciaio, il totale degli elementi leganti non deve superare il 50%. Materiale con doti di resistenza, durezza ed elasticità molto maggiori di quelle del ferro semplice. I prodotti Agape subiscono trattamenti superficiali di lucidatura o di satinatura.

Finishings / Finiture

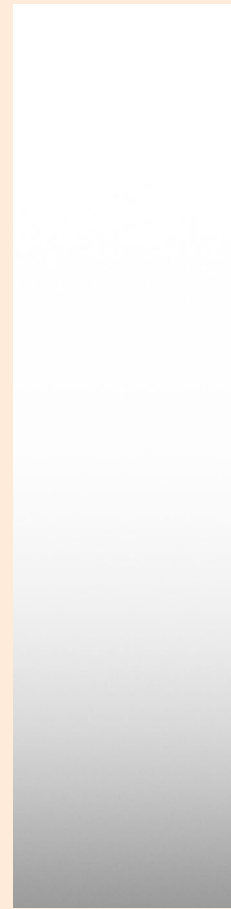

Polished finish / Lucido



Satin finish / Satinato

Aluminium / Alluminio

Aluminium is a soft, light metal, with a bright silver colour due to the thin oxide layer which quickly forms when it is exposed to the air. It is extremely resistant to atmospheric corrosion and therefore does not require any protective varnish, although it can take a wide range of finishes, from varnish coating to coloured anodising treatments.

Aluminium is neither magnetic, nor toxic, nor inflammable.

L'alluminio è un metallo morbido e leggero con un colore argenteo vivo, dovuto ad uno strato sottile di ossidazione che si forma rapidamente quando è esposto all'aria.

È estremamente resistente alla corrosione atmosferica: per tale ragione non richiede nessuna verniciatura di protezione, ma può essere ugualmente trattato con un'ampia gamma di rivestimenti, dalle verniciature alle anodizzazioni colorate.

L'alluminio non è magnetico, né tossico, né infiammabile.

Finishings / Finiture

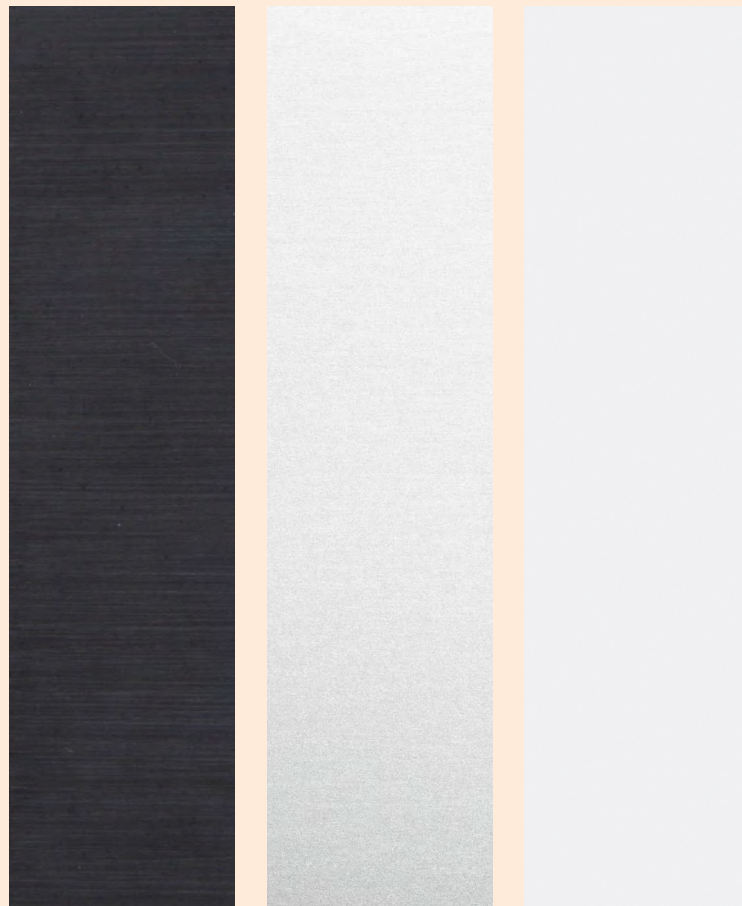

Black brushed anodized / Anodizzato spazzolato nero

Natural brushed anodized / Anodizzato spazzolato naturale

Painted white / Verniciato bianco

Brass / Ottone

The term "brass" designates a copper-zinc alloy, which belongs to the large family of bronze. Its resistance and versatility of applications make it a very useful metal. Agape brass products undergo surface treatments of bright chrome plating, painting or burnishing.

Col nome di ottone si indica una lega di rame e zinco, compresa nella più ampia famiglia del bronzo. È un metallo molto utile, grazie alla sua resistenza e lavorabilità. I prodotti Agape in ottone subiscono trattamenti superficiali di cromatura lucida, di verniciatura o brunitura.

Finishings / Finiture

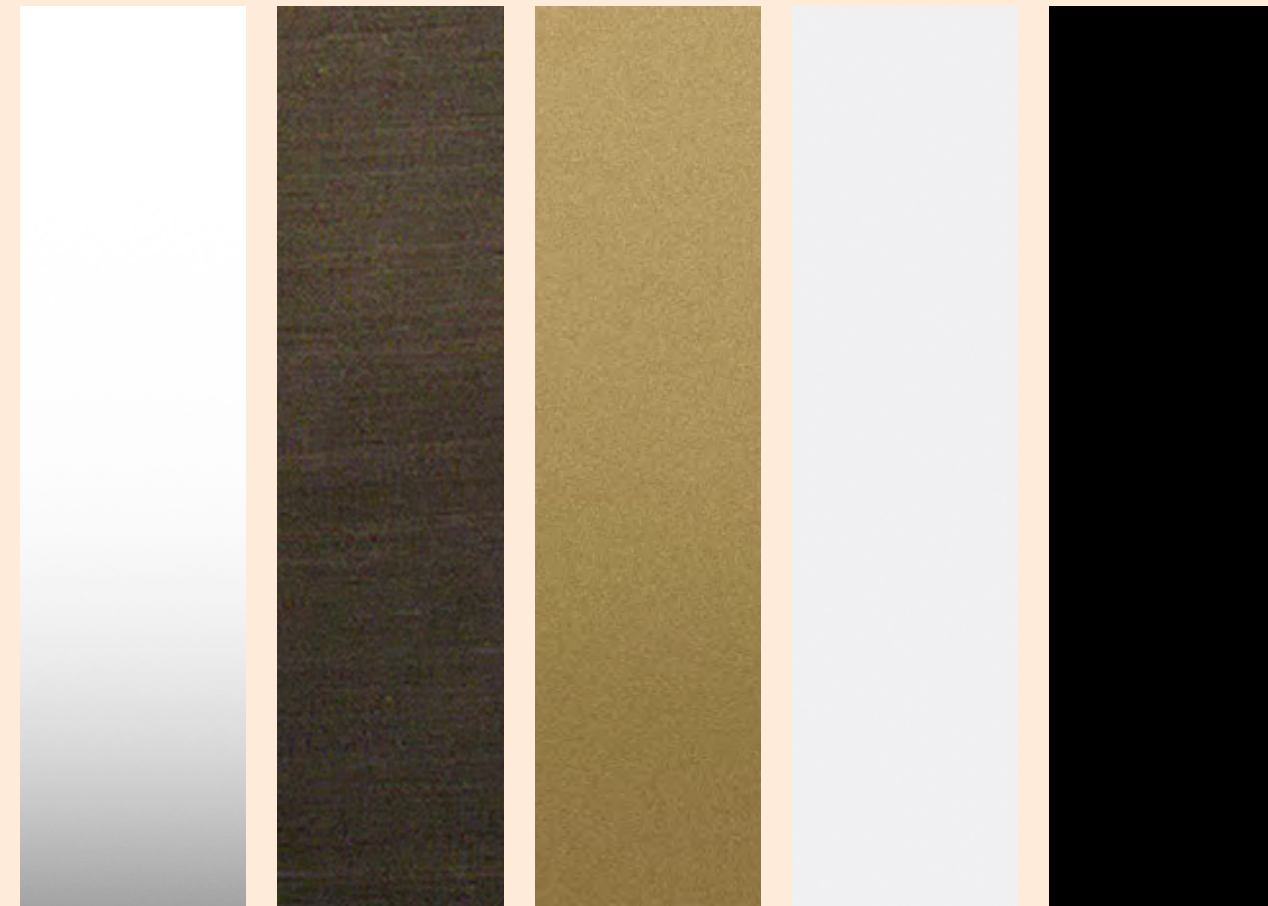

Chrome / Cromo

Brushed burnished / Brunito spazzolato

Natural burnished / Naturale spazzolato

Painted white / Verniciato bianco

Painted black / Verniciato nero

Crystal glass / Cristallo

Principally composed by silicates, it is obtained by fusing siliceous sand with carbonates. Thanks to its perfect transparency, its inalterable nature and its ability to react to light in multiform ways, crystal glass works well in combination with the other materials that characterise Agape's production range. The joints between the various elements are made with special glue to ensure the perfect transparency and continuity of the material.

Costituito essenzialmente da silicati è ottenuto per fusione di sabbia silicea con ossidi e carbonati. Grazie alla perfetta trasparenza, all'inalterabilità e alla capacità di reagire alla luce in forma mutevole, il cristallo trova particolare applicazione negli accostamenti con gli altri materiali che compongono la produzione Agape. Le giunzioni tra le parti sono realizzate con speciali collanti che garantiscono la perfetta trasparenza e continuità del materiale.

Finishings / Finiture

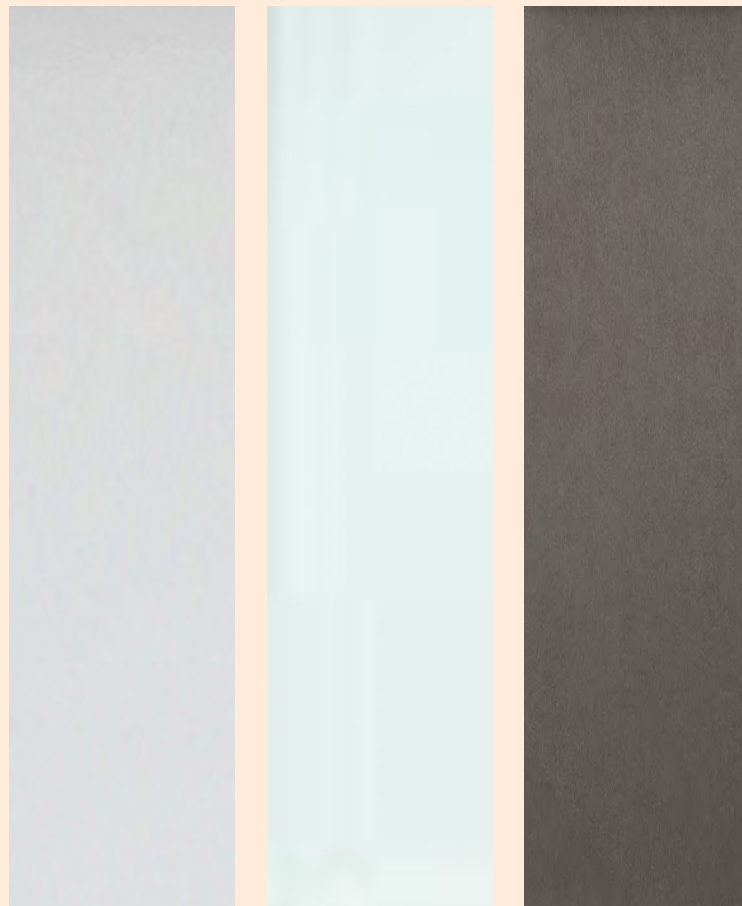

Transparent /
Trasparente

Extraclear /
Extrachiario

Fumé / Fumé

Silicon rubber / Gomma siliconica

Silicon rubber is a polymer elastomer containing atoms of silicon and oxygen. The composition is stable and irreversible, the mechanical and elastic properties of the material do not undergo change within the temperature range -100 to 250°C. The special characteristics of silicon rubber are its softness, its total non-toxicity (it is even used in mould making for the food industry) and its pure colour. Qualities that make it ideal for applications where the material comes into direct contact with the human body and with water, given its total resistance to oxidation and to solvents. The flexibility allows to remove the limestone that could settle during the use of the item.

La gomma siliconica è un polimero elastomero contenente atomi di silicio e di ossigeno. Il composto è stabile ed irreversibile, le proprietà meccaniche ed elastiche del materiale non subiscono variazioni in intervalli di temperature che possono oscillare da -100 a 250°C. Le caratteristiche peculiari della gomma siliconica sono la morbidezza, la totale atossicità (tanto da essere utilizzata per gli stampi alimentari) e la colorazione pura. Qualità che permettono un'applicazione ideale laddove il materiale entra a contatto diretto con il corpo e con l'acqua data la totale resistenza all'ossidazione ai solventi. La flessibilità permette di rimuovere facilmente il calcare che si deposita durante l'utilizzo del prodotto.

Finishings / Finiture

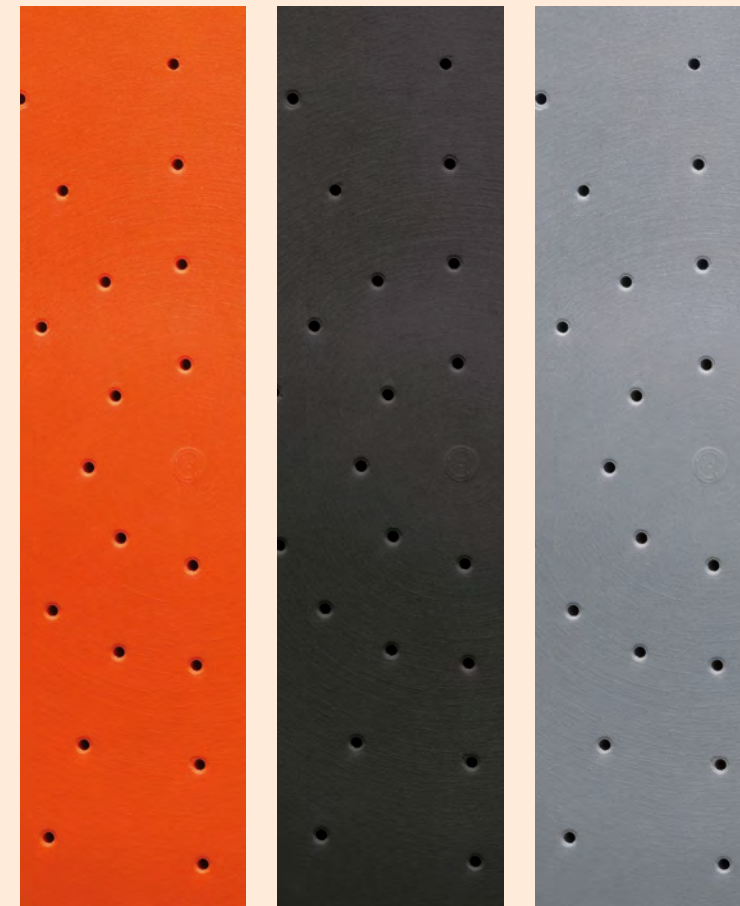

Orange / Arancio

Dark grey / Grigio
scuro

Grey / Grigio

Leather / Cuoio

Leather is the material obtained from animal skin which, following a process called 'tanning', is rendered rot-proof. Leather has very high resistance and above all hygienic characteristics which make it particularly suitable for the production of many commonly used products.

Il cuoio è il materiale ricavato dalla pelle degli animali la quale, in seguito a un processo denominato "concia" viene resa imputrescibile. Il cuoio ha caratteristiche di resistenza e soprattutto igieniche molto elevate che lo rendono particolarmente adatto alla produzione di molti manufatti di uso comune.

Finishings / Finiture



Raw / Raw

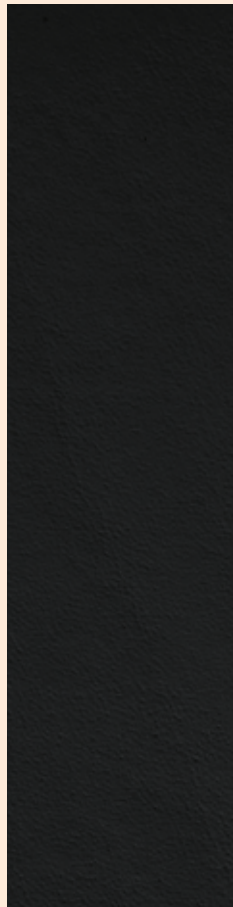

Black / Nero



Green / Verde

Special finishes / Finiture speciali

CU	Copper PVD *
GM	Gun metal PVD *
NI	Nikel brushed / Nichel spazzolato
NL	Natural polished brass / ottone naturale lucido **

* Physical Vapor Deposition

** Natural polished brass. Customised finishes starting from a base of natural brass are available on request / Ottone naturale lucido. A richiesta sono disponibili finiture personalizzate su base ottone naturale

Graphic design: Agape
Illustrations: Marta Lonardi
Copywriting: Agape
Photography: Andrea Ferrari, F2, Leo Torri, Studio Haas,
Luca Marri, Maurizio Zatachetto, Matteo Lavazza Seranto,
Giorgio Possenti, José Rodriguez, Contratti Company,
Filippo Bamberghi, Juan Rodriguez
Render: Agape, Archè, Virtual Design, Andrea Gnesato

CATELEMENTS2204

©Agape srl 04.2022

Agape srl
via A. Pitentino, 6/46037
Governolo Roncoferraro (MN), Italy
T +39 0376 250311 / F +39 0376 250330
info@agapedesign.it www.agapedesign.it