

**MODULARITY / MODULARITÄT**

Wall-mounted base units H. 25.5  
Hängeunterschränke H. 25.5

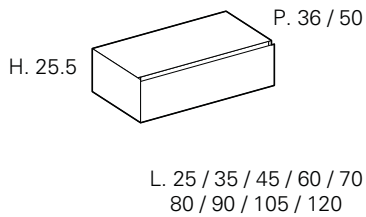

Wall mounted washbasin units H. 25.5  
Waschtischhängeschränke H. 25.5

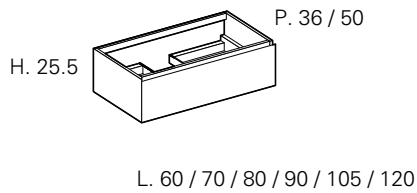

Bottom wall-mounted base units H. 25.5  
Untere Hängeunterschränke H. 25.5  
(for staggered composition-für versetzte Lösungen)

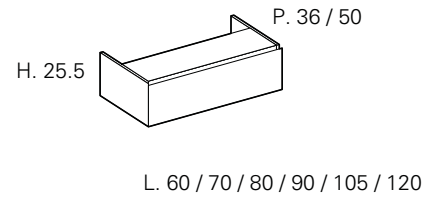

Wall-mounted base units H. 35  
Hängeunterschränke H. 35

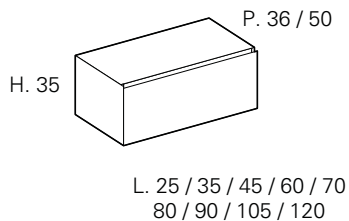

Wall mounted washbasin units H. 35  
Waschtischhängeschränke H. 35

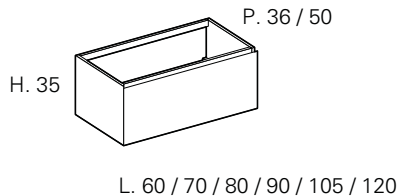

Wall-mounted base units H. 48.5  
Hängeunterschränke H. 48.5

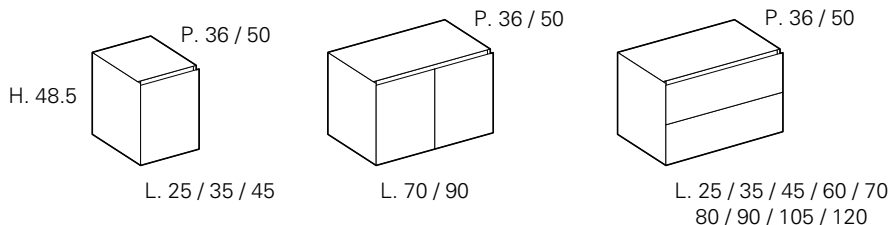

Wall mounted washbasin units H. 48.5  
Waschtischhängeschränke H. 48.5

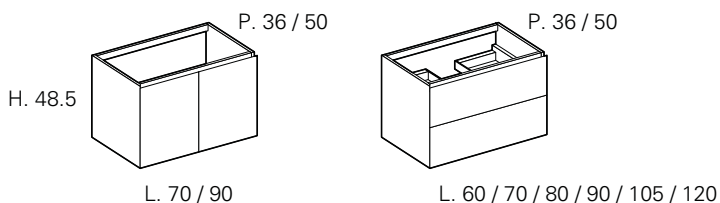

**NOTE:** FOR FALSE WALLS (e.g. plasterboard), USE SUITABLE REINFORCEMENTS see page 08  
**ACHTUNG:** IM FALL VON ZWISCHENWÄNDEN (z. B. Gipskartonwände) ANGEMESSENE VERSTÄRKUNGEN VORSEHEN, siehe S. 08

## MODULARITY / MODULARITÄT

Floor-standing base units H. 83.5+6 (plinth)  
*Standunterschranke H. 83.5+6 (Sockel)*

Floor-standing washbasin units H. 83.5+6 (plinth)  
*Standunterhängeschranke H. 83.5+6 (Sockel)*

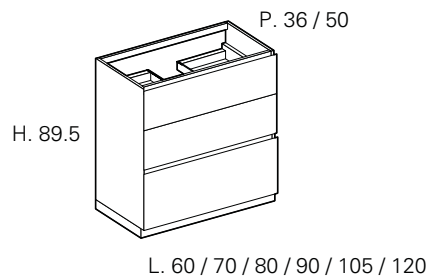
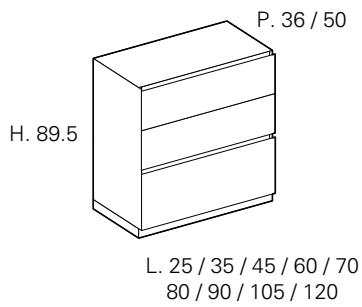

Washbasin units "Cubik"  
*Washbeckenunterschranke "Cubik"*

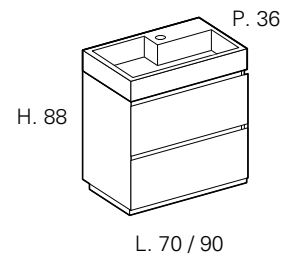
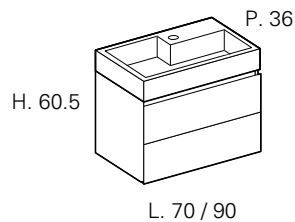
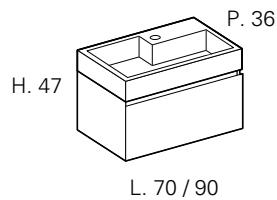
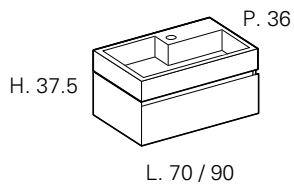

Washing machine base units H. 89.5  
*Waschmaschinenschranke H. 89.5*

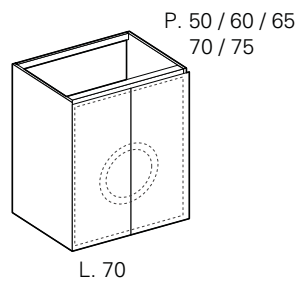
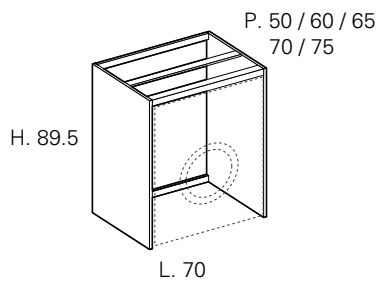

**NOTE:** FOR FALSE WALLS (e.g. plasterboard), USE SUITABLE REINFORCEMENTS see page 08  
**ACHTUNG:** IM FALL VON ZWISCHENWÄNDEN (z. B. Gipskartonwände) ANGEMESSENE VERSTÄRKUNGEN VORSEHEN, siehe S. 08

# MODULARITY / MODULARITÄT

## Wall Units H. 70 Elemente H. 70

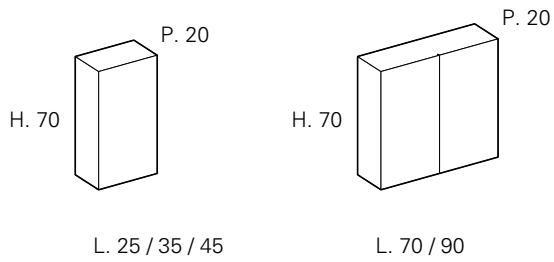

## Double-sided mirrored wall units H. 70 Spiegel-Hängeelemente doppelseitig H. 70

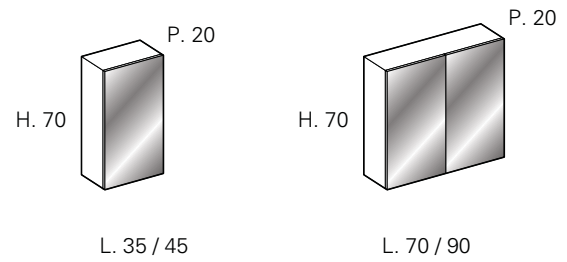

## Wall Units H. 90 Elemente H. 90

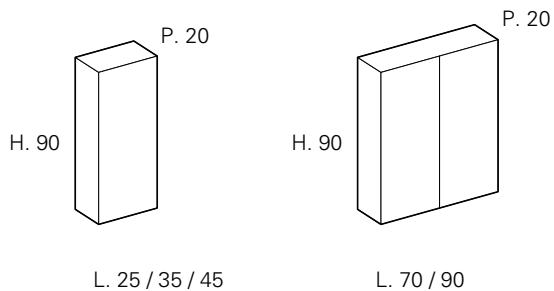

## Double-sided mirrored wall units H. 90 Spiegel-Hängeelemente doppelseitig H. 90

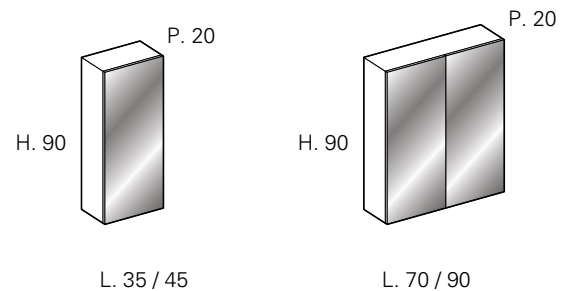

## Glass open units Offenelemente aus Glas

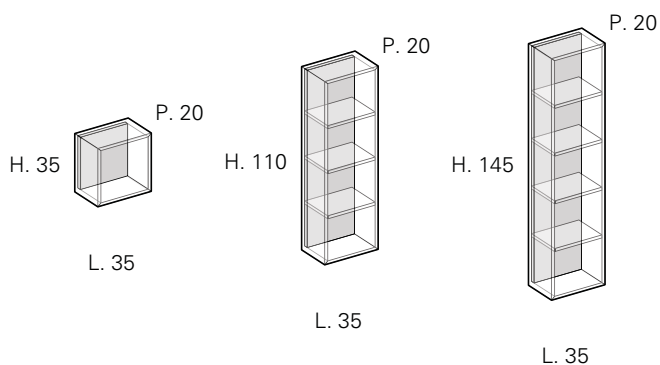

**NOTE:** FOR FALSE WALLS (e.g. plasterboard), USE SUITABLE REINFORCEMENTS see page 08  
**ACHTUNG:** IM FALL VON ZWISCHENWÄNDEN (z. B. Gipskartonwände) ANGEMESSENE VERSTÄRKUNGEN VORSEHEN, siehe S. 08

---

**MODULARITY / MODULARITÄT**

---

Tall units H. 126  
Hochschranke H. 126

Tall units H. 157.7  
Hochschranke H. 157.7

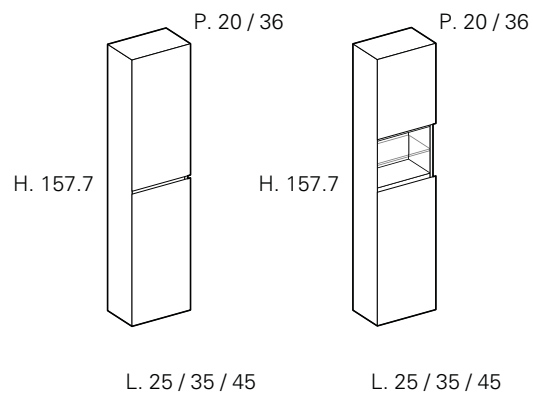
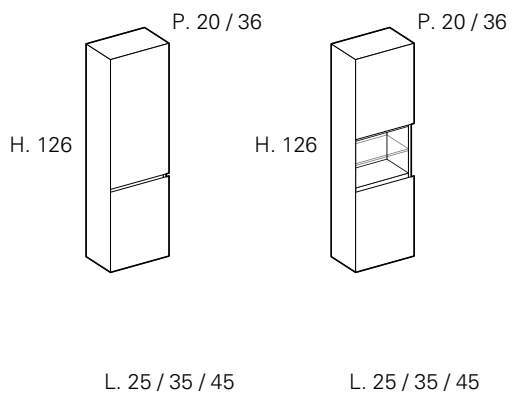



---

**NOTE:** FOR FALSE WALLS (e.g. plasterboard), USE SUITABLE REINFORCEMENTS see page 08  
**ACHTUNG:** IM FALL VON ZWISCHENWÄNDEN (z. B. Gipskartonwände) ANGEMESSENE VERSTÄRKUNGEN VORSEHEN, siehe S. 08

---

# MODULARITY / MODULARITÄT

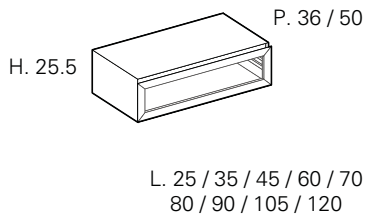
Wall-mounted base units H. 25.5  
Hängeunterschränke H. 25.5



Wall mounted washbasin units H. 25.5  
Waschtischhängeschränke H. 25.5

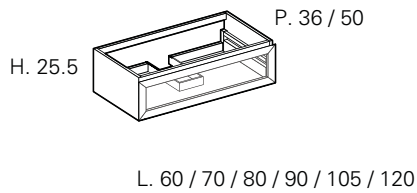

Bottom wall-mounted base units H. 25.5  
Untere Hängeunterschränke H. 25.5  
(for staggered composition-für versetzte Lösungen)

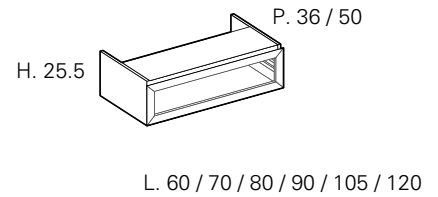

Wall-mounted base units H. 35  
Hängeunterschränke H. 35

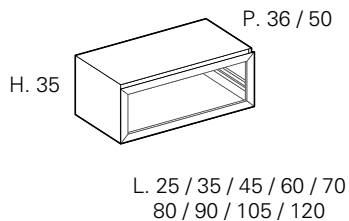

Wall mounted washbasin units H. 35  
Waschtischhängeschränke H. 35

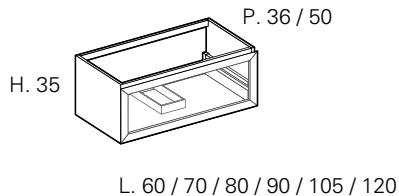

Wall-mounted base units H. 48.5  
Hängeunterschränke H. 48.5

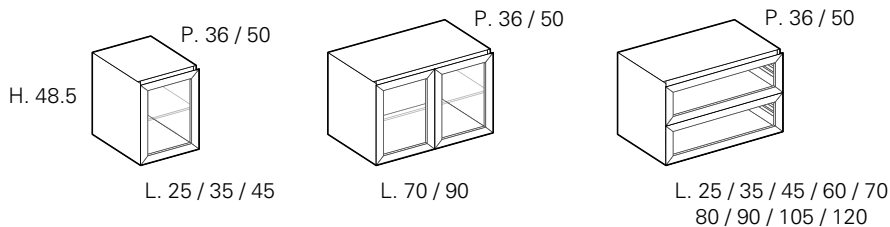

Wall mounted washbasin units H. 48.5  
Waschtischhängeschränke H. 48.5

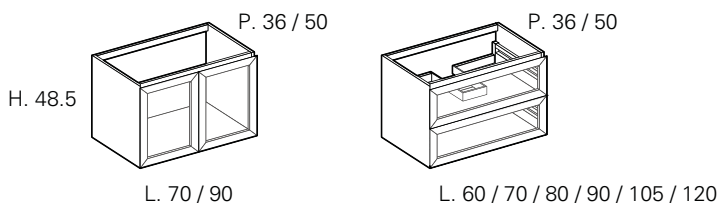

**NOTE:** FOR FALSE WALLS (e.g. plasterboard), USE SUITABLE REINFORCEMENTS see page 08  
**ACHTUNG:** IM FALL VON ZWISCHENWÄNDEN (z. B. Gipskartonwände) ANGEMESSENE VERSTÄRKUNGEN VORSEHEN, siehe S. 08

## MODULARITY / MODULARITÄT

Floor-standing base units H. 83.5+6 (plinth)  
*Standunterschranke H. 83.5+6 (Sockel)*

Floor-standing washbasin units H. 83.5+6 (plinth)  
*Standunterhängeschranke H. 83.5+6 (Sockel)*

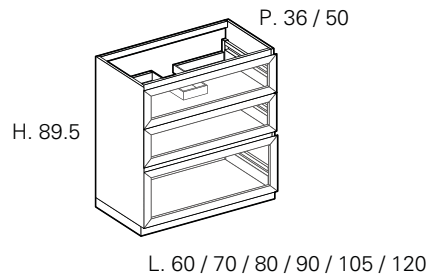
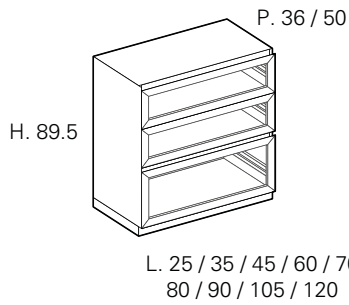

Washbasin units "Cubik"  
*Washbeckenunterschranke "Cubik"*

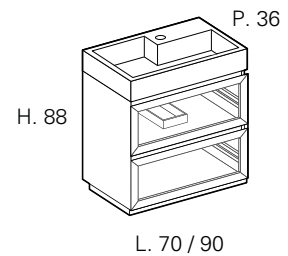
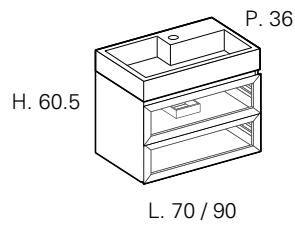
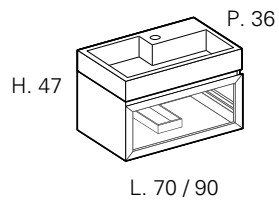
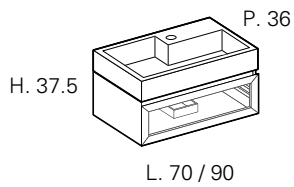

**NOTE:** FOR FALSE WALLS (e.g. plasterboard), USE SUITABLE REINFORCEMENTS see page 08  
**ACHTUNG:** IM FALL VON ZWISCHENWÄNDEN (z. B. Gipskartonwände) ANGEMESSENE VERSTÄRKUNGEN VORSEHEN, siehe S. 08

# MODULARITY / MODULARITÄT

## Wall Units H. 70 Elemente H. 70

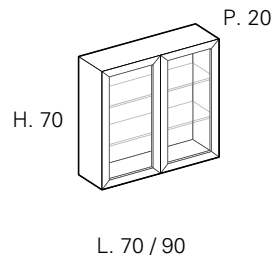
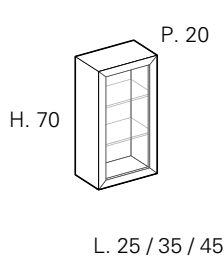

## Double-sided mirrored wall units H. 70 Spiegel-Hängeelemente doppelseitig H. 70

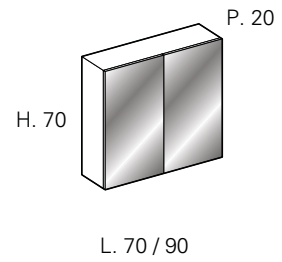
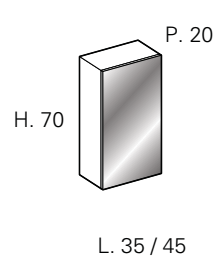

## Wall Units H. 90 Elemente H. 90

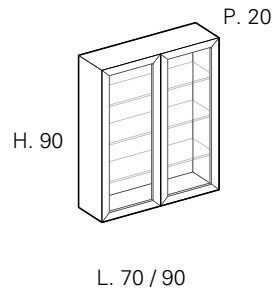
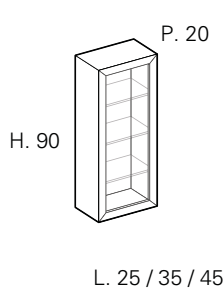

## Double-sided mirrored wall units H. 90 Spiegel-Hängeelemente doppelseitig H. 90

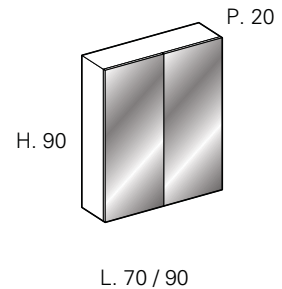
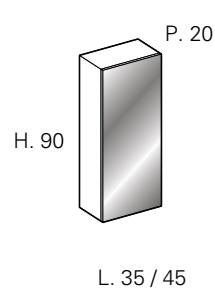

## Wall Units H. 126 Elemente H. 126

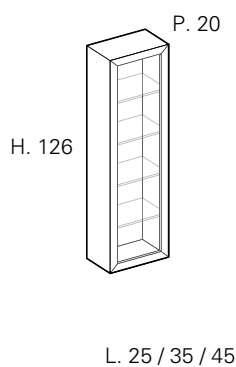

## Glass open units Offenelemente aus Glas

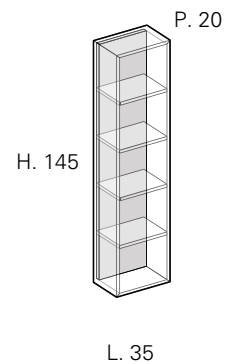
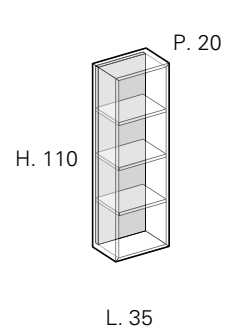
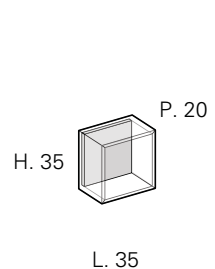

**NOTE:** FOR FALSE WALLS (e.g. plasterboard), USE SUITABLE REINFORCEMENTS see page 08  
**ACHTUNG:** IM FALL VON ZWISCHENWÄNDEN (z. B. Gipskartonwände) ANGEMESSENE VERSTÄRKUNGEN VORSEHEN, siehe S. 08

---

**MODULARITY / MODULARITÄT**

---

Tall units H. 126  
Hochschranke H. 126

Tall units H. 157.7  
Hochschranke H. 157.7

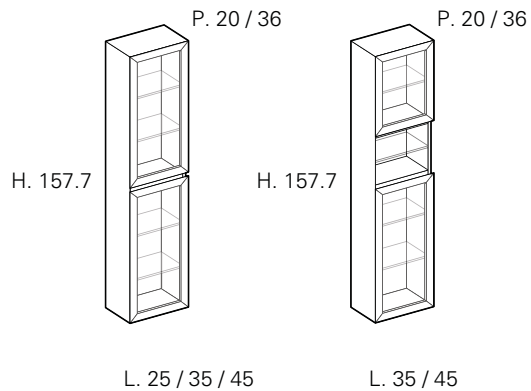
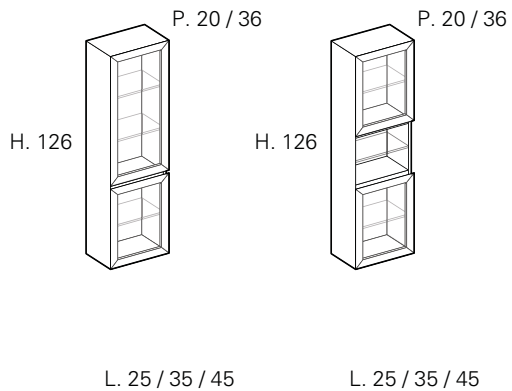

---

**NOTE:** FOR FALSE WALLS (e.g. plasterboard), USE SUITABLE REINFORCEMENTS see page 08  
**ACHTUNG:** IM FALL VON ZWISCHENWÄNDEN (z. B. Gipskartonwände) ANGEMESSENE VERSTÄRKUNGEN VORSEHEN, siehe S. 08

---